

US00D501720S

(12) **United States Design Patent**
Hussaini et al.

(10) **Patent No.: US D501,720 S**

(45) **Date of Patent: ** Feb. 15, 2005**

(54) **STORAGE CASE**

(75) Inventors: **Saied Hussaini**, Miami, FL (US); **Marc Iacovelli**, Miami, FL (US)

(73) Assignee: **Intec, Inc.**, Miami, FL (US)

(**) Term: **14 Years**

(21) Appl. No.: **29/187,871**

(22) Filed: **Aug. 11, 2003**

(51) **LOC (7) Cl. 03-01**

(52) **U.S. Cl. D3/273; D3/294**

(58) **Field of Search D3/272, 273, 276,**
D3/281, 291, 294, 295; 190/100, 101, 115,
122, 123, 127

(56) **References Cited**

U.S. PATENT DOCUMENTS

1,543,999	A	*	6/1925	Goldsmith	190/37
1,638,470	A	*	8/1927	Caldwell	190/37
D129,108	S	*	8/1941	Sprague	D3/268
2,626,025	A	*	1/1953	Sherman	190/37
D247,993	S	*	5/1978	Calzone, III	D3/204
D337,657	S	*	7/1993	March et al.	D3/272

D351,502	S	*	10/1994	Weir et al.	D3/272
D378,164	S	*	2/1997	Lee	D3/276
D414,037	S	*	9/1999	Akaike et al.	D3/276
D415,614	S	*	10/1999	Akaike et al.	D3/276
D419,766	S	*	2/2000	Rekuc	D3/272

* cited by examiner

Primary Examiner—Philip S. Hyder

(74) *Attorney, Agent, or Firm*—Liniak, Berenato & White

(57) **CLAIM**

The ornamental design for a storage case, as shown and described.

DESCRIPTION

FIG. 1 is a top view of the storage case according to the present invention.

FIG. 2 is a front view of the storage case of FIG. 1.

FIG. 3 is a rear view of the storage case of FIG. 1.

FIG. 4 is a left side view of the storage case of FIG. 1.

FIG. 5 is a right side view of the storage case of FIG. 1.

FIG. 6 is a bottom view of the storage case of FIG. 1; and,

FIG. 7 is a perspective view of the storage case according to the present invention.

1 Claim, 7 Drawing Sheets

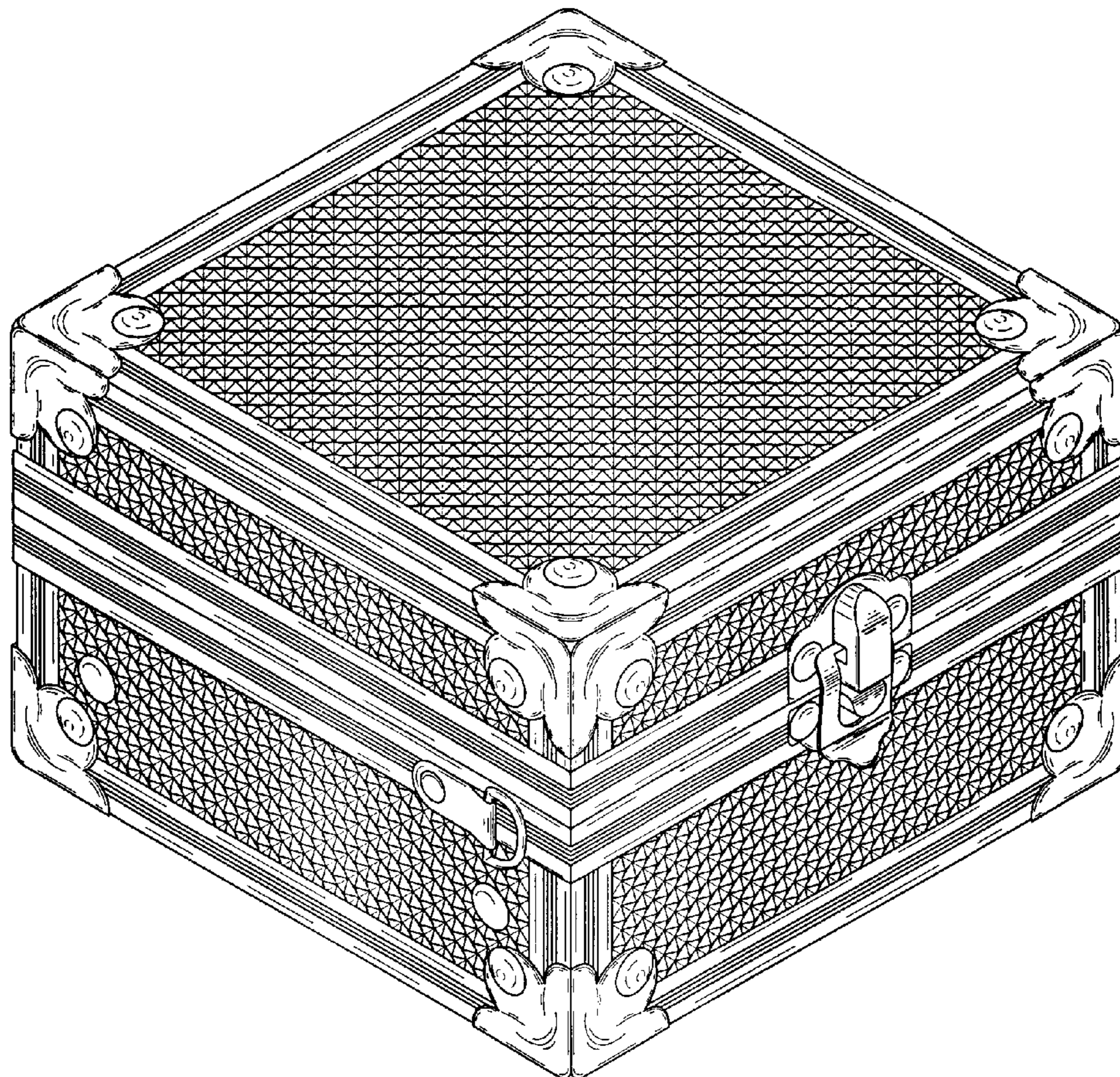

Fig. 1

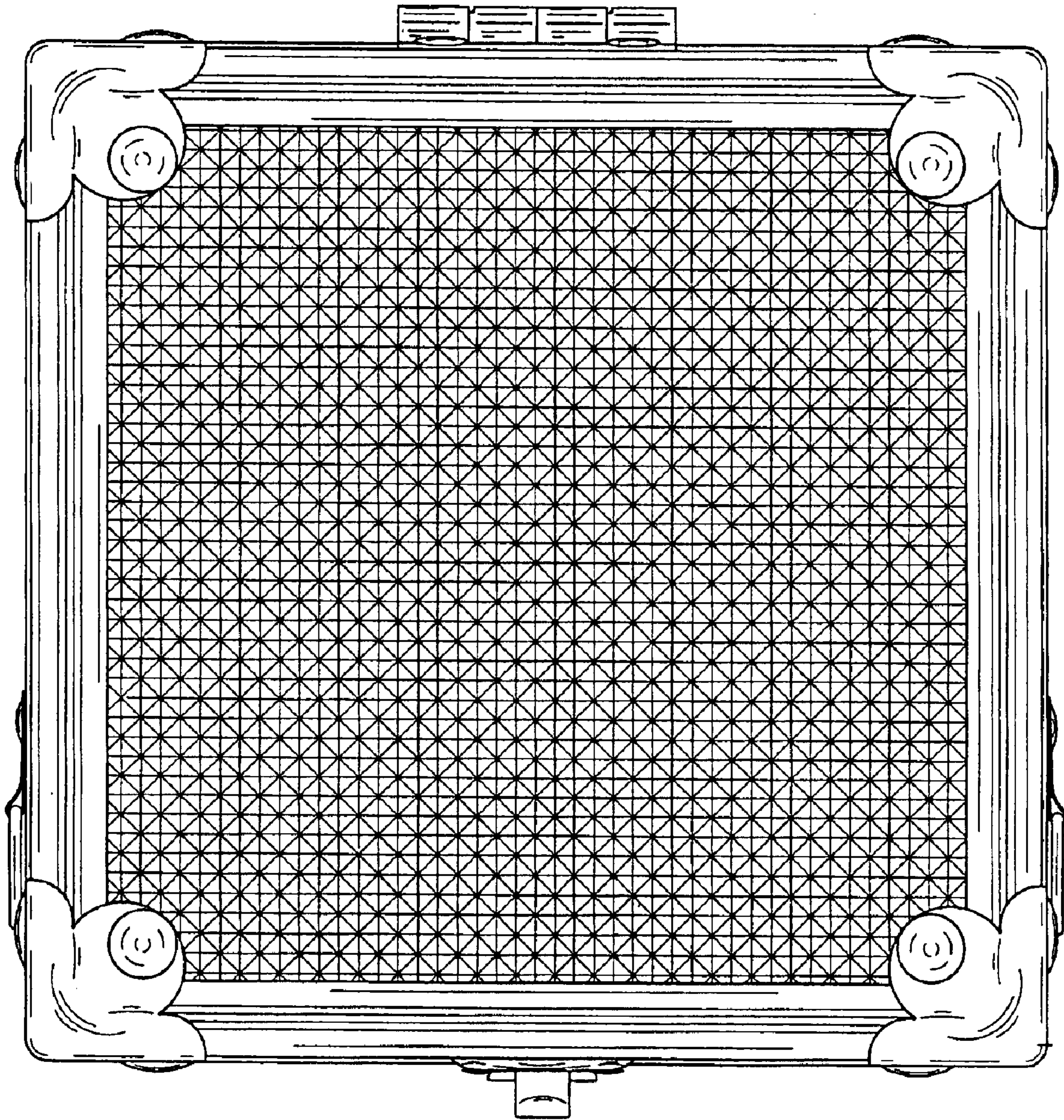

Fig. 2

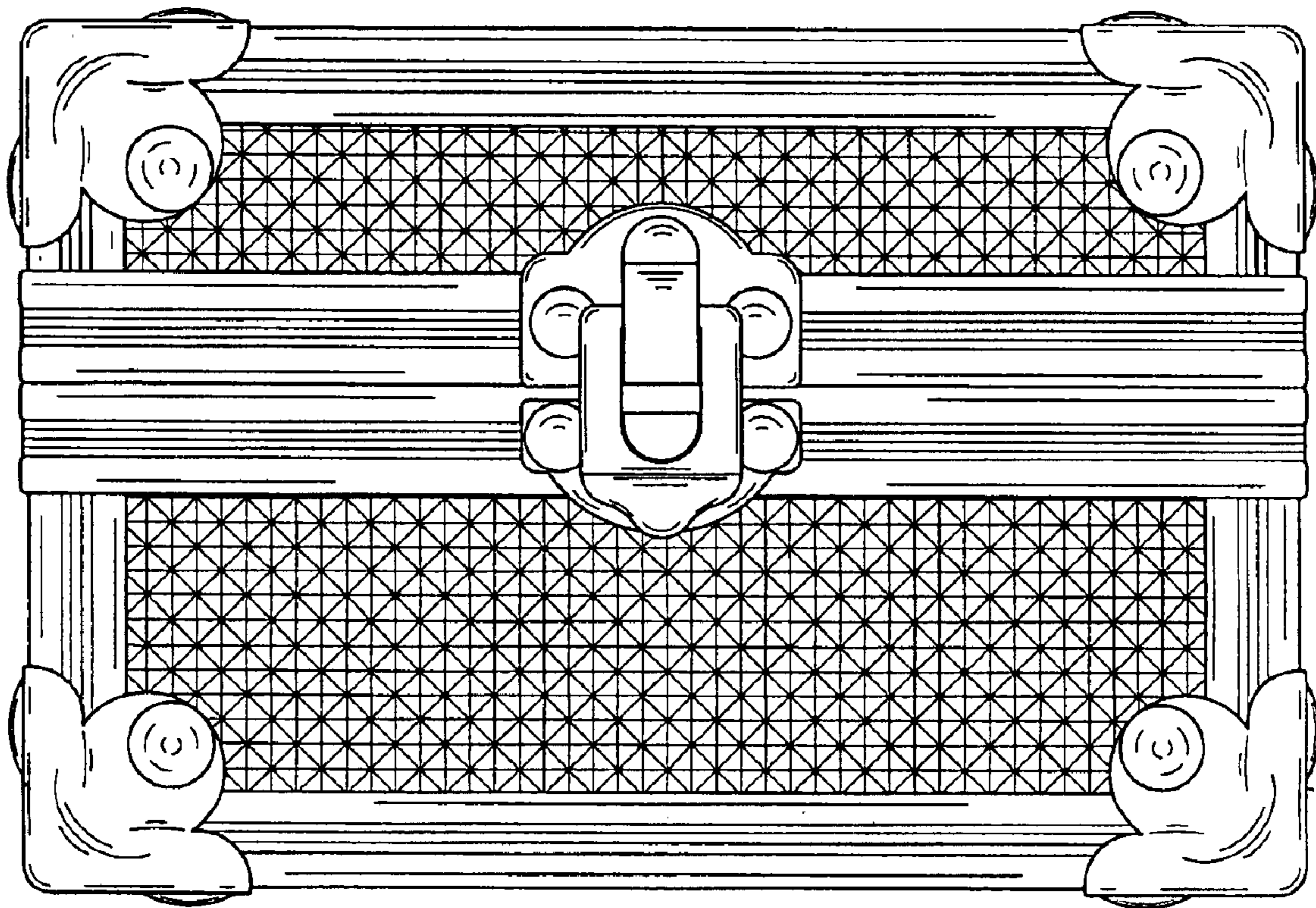

Fig. 3

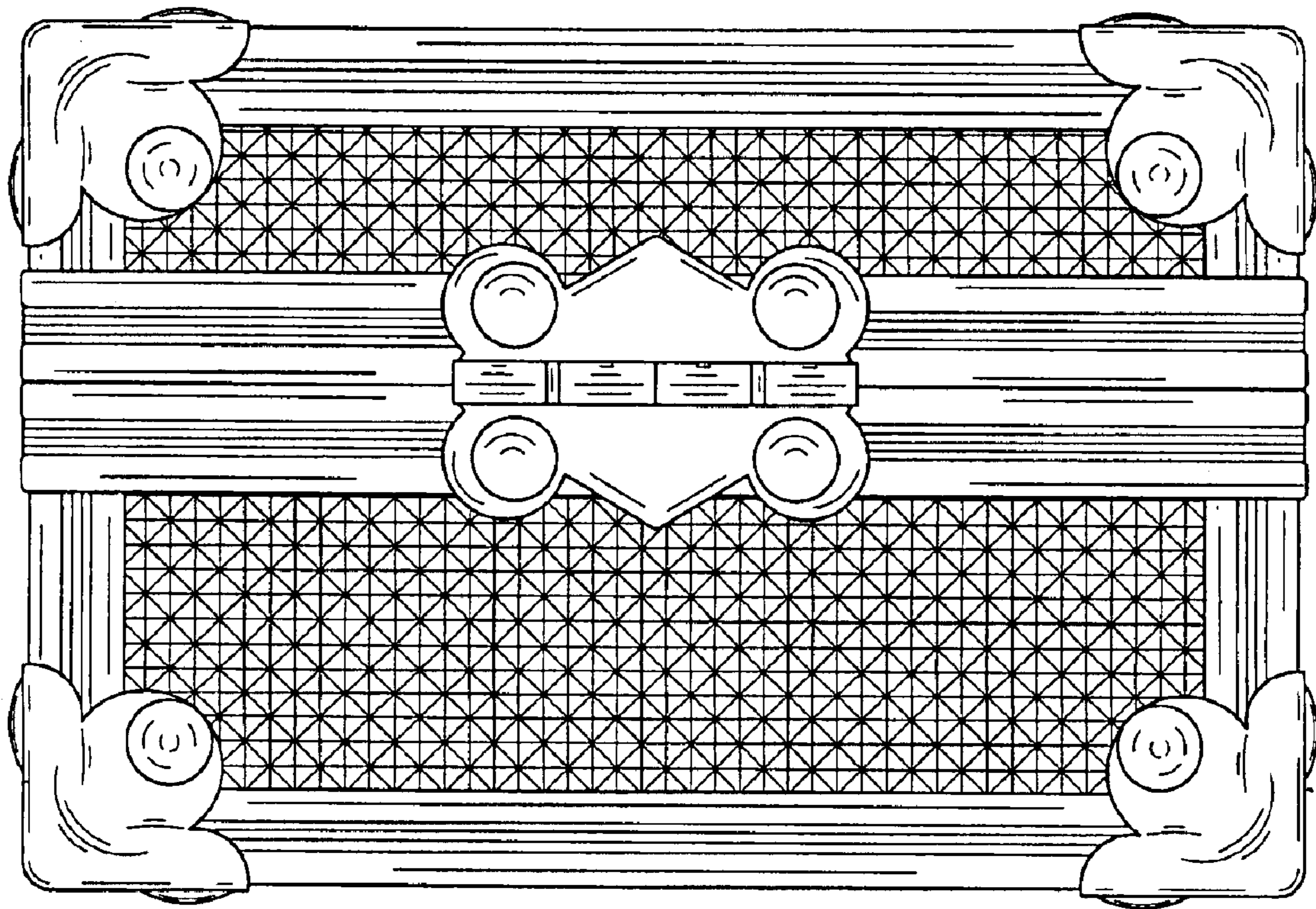

Fig. 4

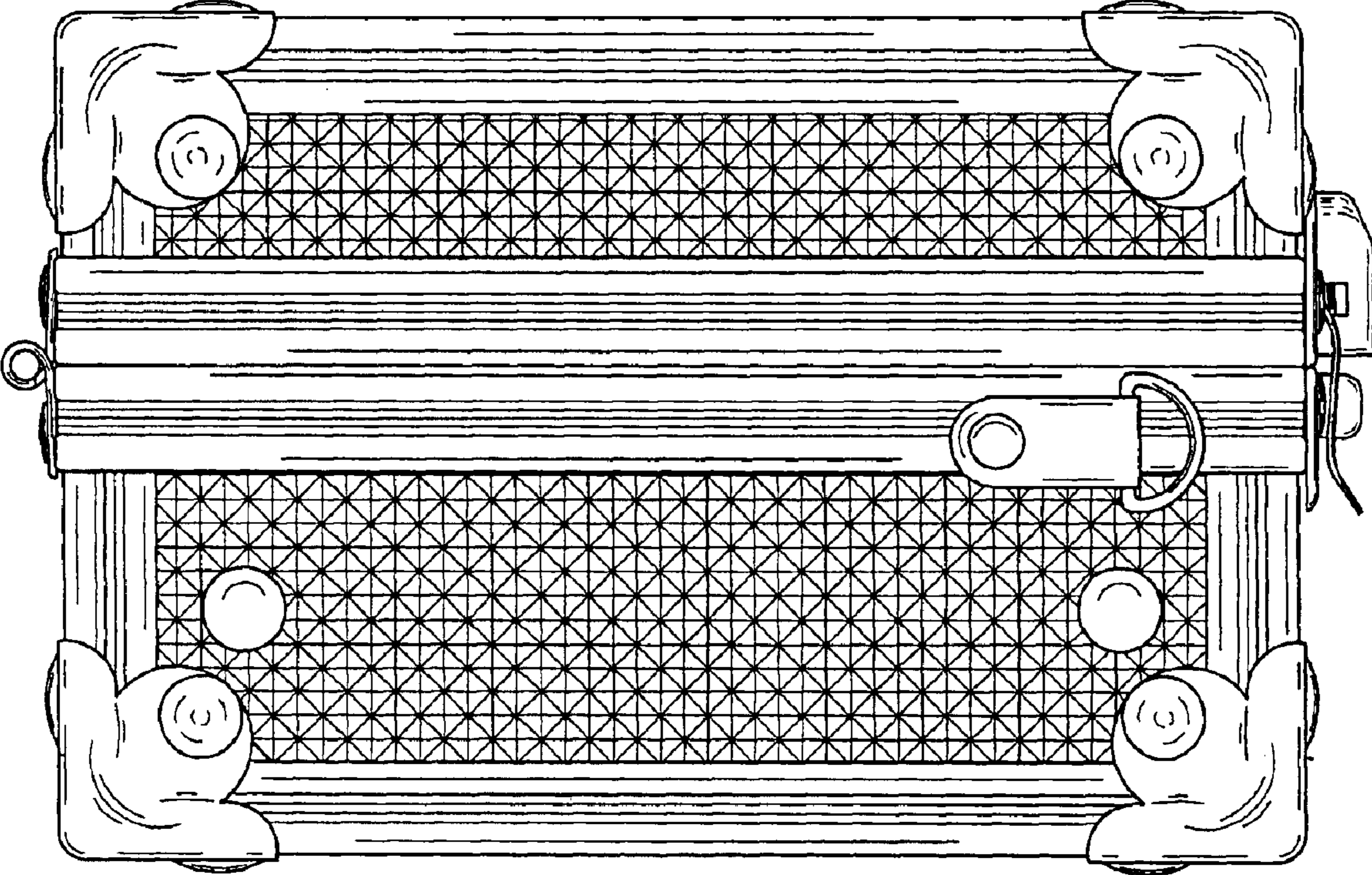

Fig. 5

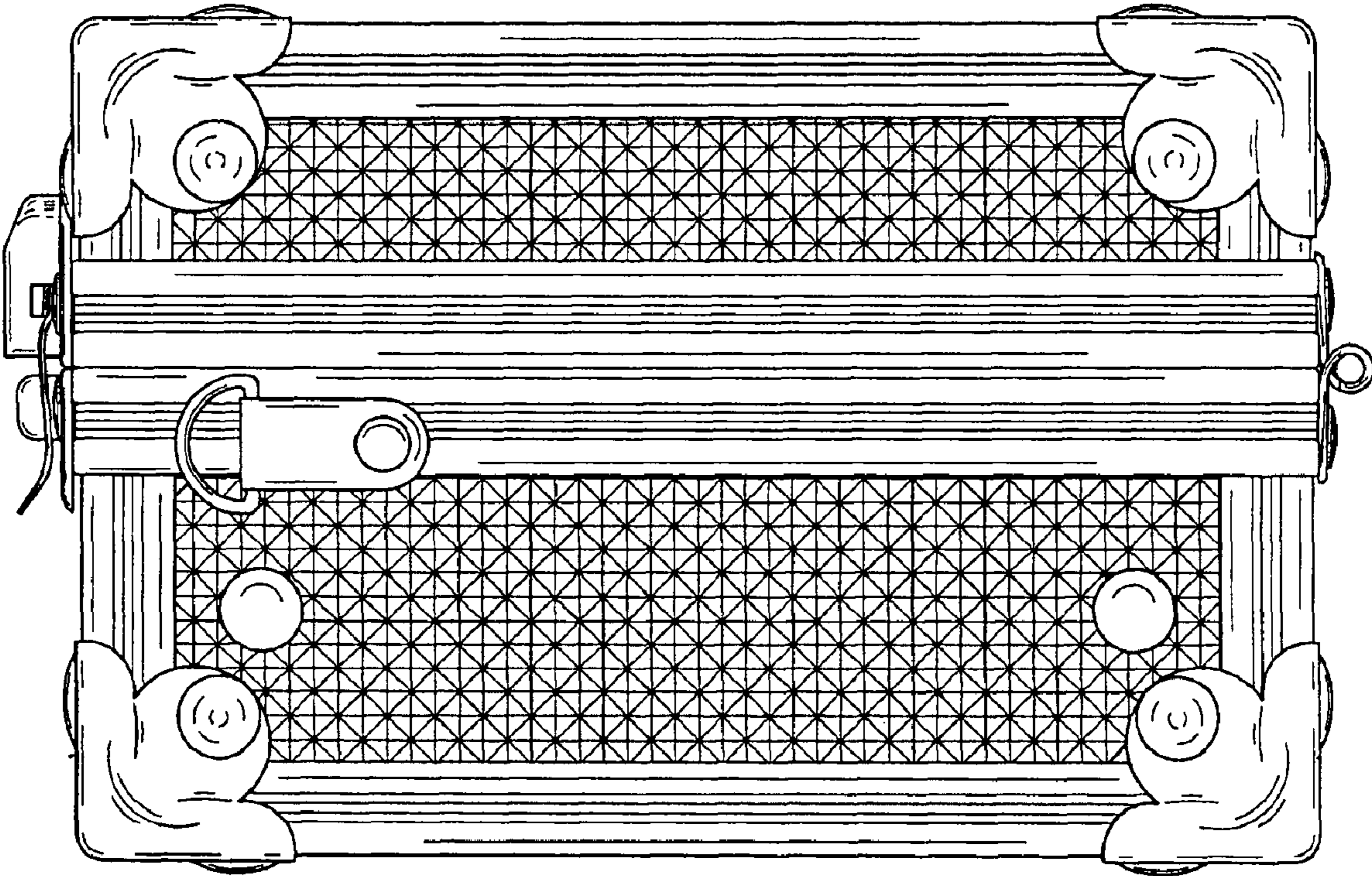

Fig. 6

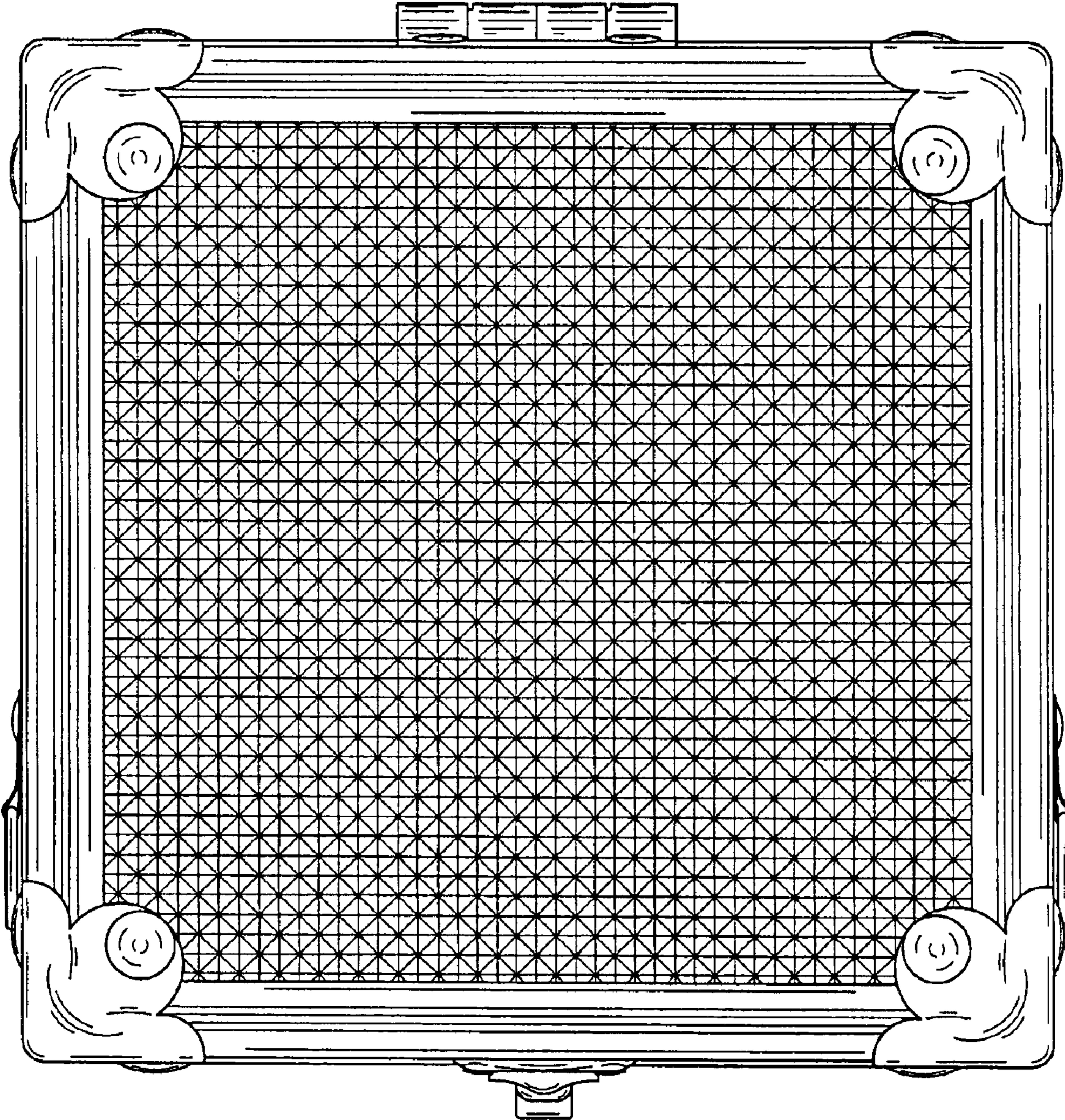

Fig. 7

