



US00D501680S

(12) **United States Design Patent** (10) **Patent No.:** **US D501,680 S**  
**Smith** (45) **Date of Patent:** **\*\* Feb. 8, 2005**

(54) **FLASK HOLDER**

(75) Inventor: **Richard Smith, Ipswich (GB)**

(73) Assignee: **Genevac Limited, Ipswich (GB)**

(\*\*) Term: **14 Years**

(21) Appl. No.: **29/206,187**

(22) Filed: **May 27, 2004**

**Related U.S. Application Data**

(62) Division of application No. 29/181,800, filed on May 15, 2003.

(30) **Foreign Application Priority Data**

Nov. 16, 2002	(GB)	3008735
Nov. 16, 2002	(GB)	3008736
Nov. 16, 2002	(GB)	3008737
Nov. 16, 2002	(GB)	3008738
Nov. 16, 2002	(GB)	3008739
Nov. 16, 2002	(GB)	3008740

(51) **LOC (7) Cl.** ..... **24-01**

(52) **U.S. Cl.** ..... **D24/230; D24/216; D24/227; D24/229**

(58) **Field of Search** ..... **D24/216, 227, D24/229, 230, 224; 422/99, 104, 102, 81, 65, 64; 211/74; 248/154, 311.2, 316.1, 317, 346.1, 312.1, 312; 435/288.1, 288.3, 287.3; 206/564, 562, 563, 446, 376**

(56) **References Cited**

**U.S. PATENT DOCUMENTS**

3,229,949	A	*	1/1966	Chaconas	248/346.11
D205,033	S	*	6/1966	Barrantes	D24/229
D307,869	S	*	5/1990	Miskinis	D24/227
D332,145	S	*	12/1992	Wada et al.	D24/227
D333,523	S	*	2/1993	Gianino	D24/229
D421,130	S	*	2/2000	Cohen et al.	D24/229

\* cited by examiner

*Primary Examiner*—Ian Simmons

(74) *Attorney, Agent, or Firm*—Barnes & Thornburg LLP

(57) **CLAIM**

The ornamental design for a flask holder, as shown and described.

**DESCRIPTION**

FIG. 1 is a perspective view from the front and above of a flask holder according to my invention;  
 FIG. 2 is a further perspective view thereof, from the side and above;  
 FIG. 3 is a perspective view thereof, from the front and below;  
 FIG. 4 is a top plan view thereof;  
 FIG. 5 is a bottom plan view thereof;  
 FIG. 6 is a front elevational view thereof; and,  
 FIG. 7 is a side elevational view thereof, with the opposite side corresponding.

**1 Claim, 7 Drawing Sheets**

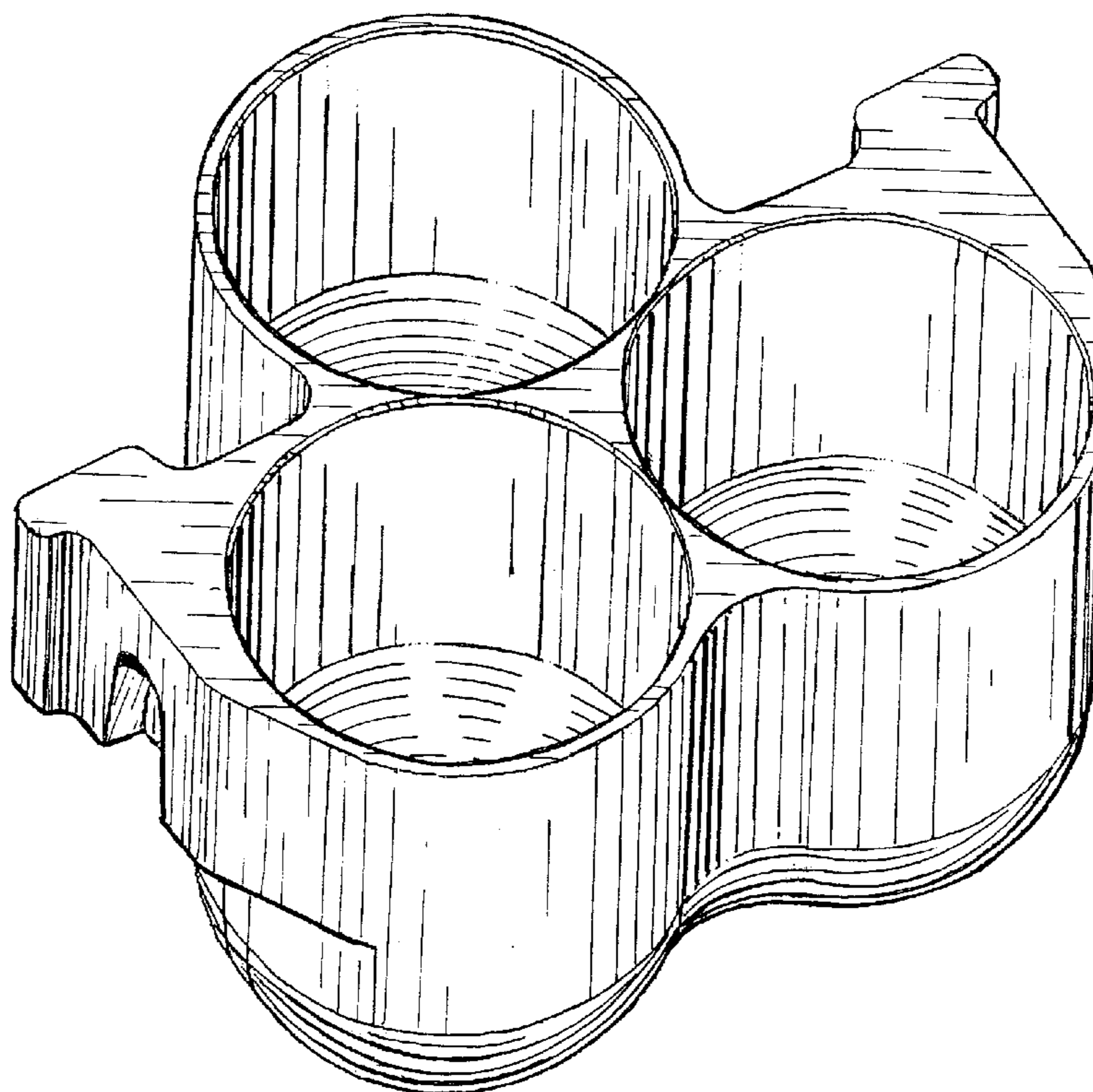

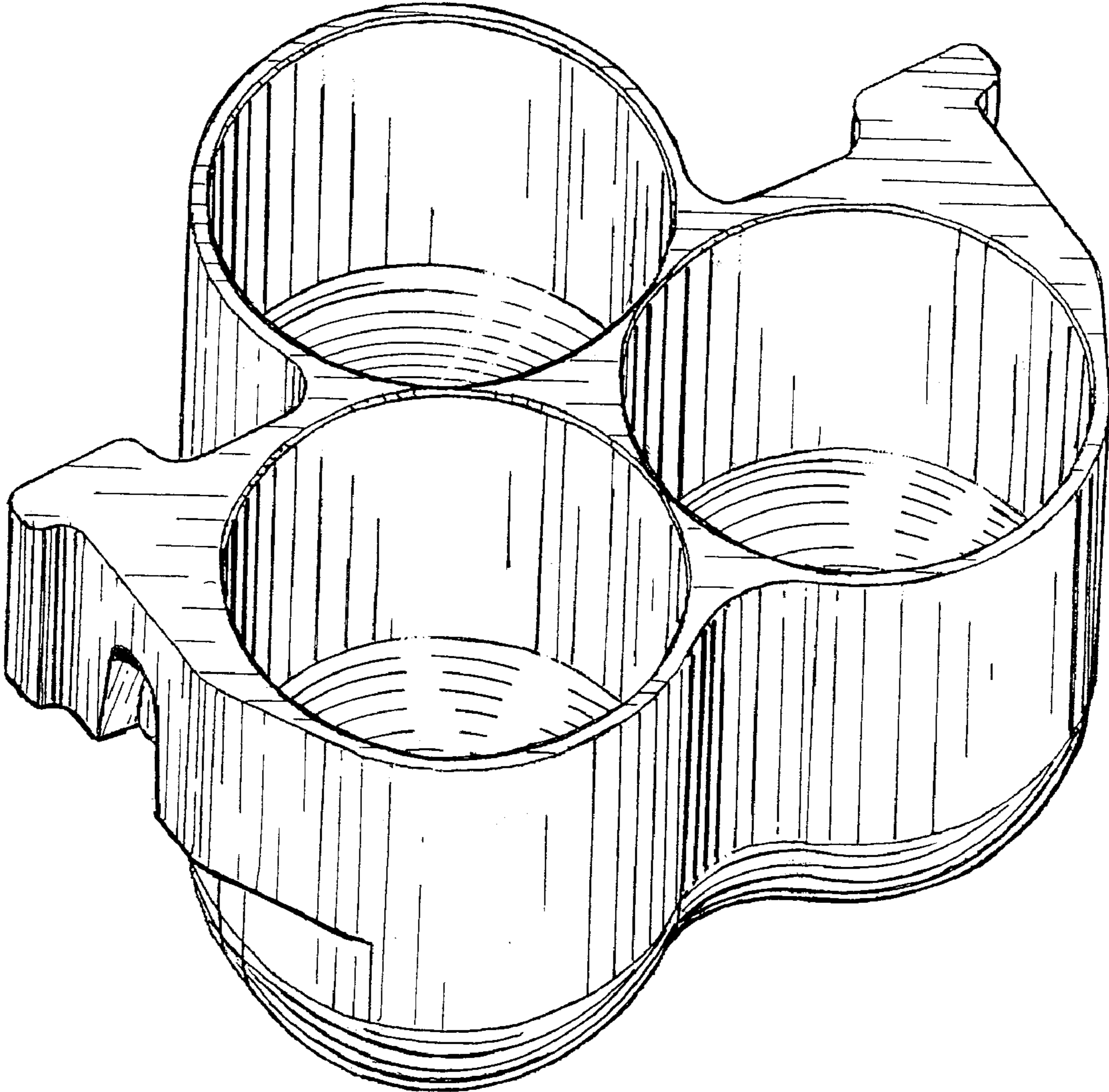
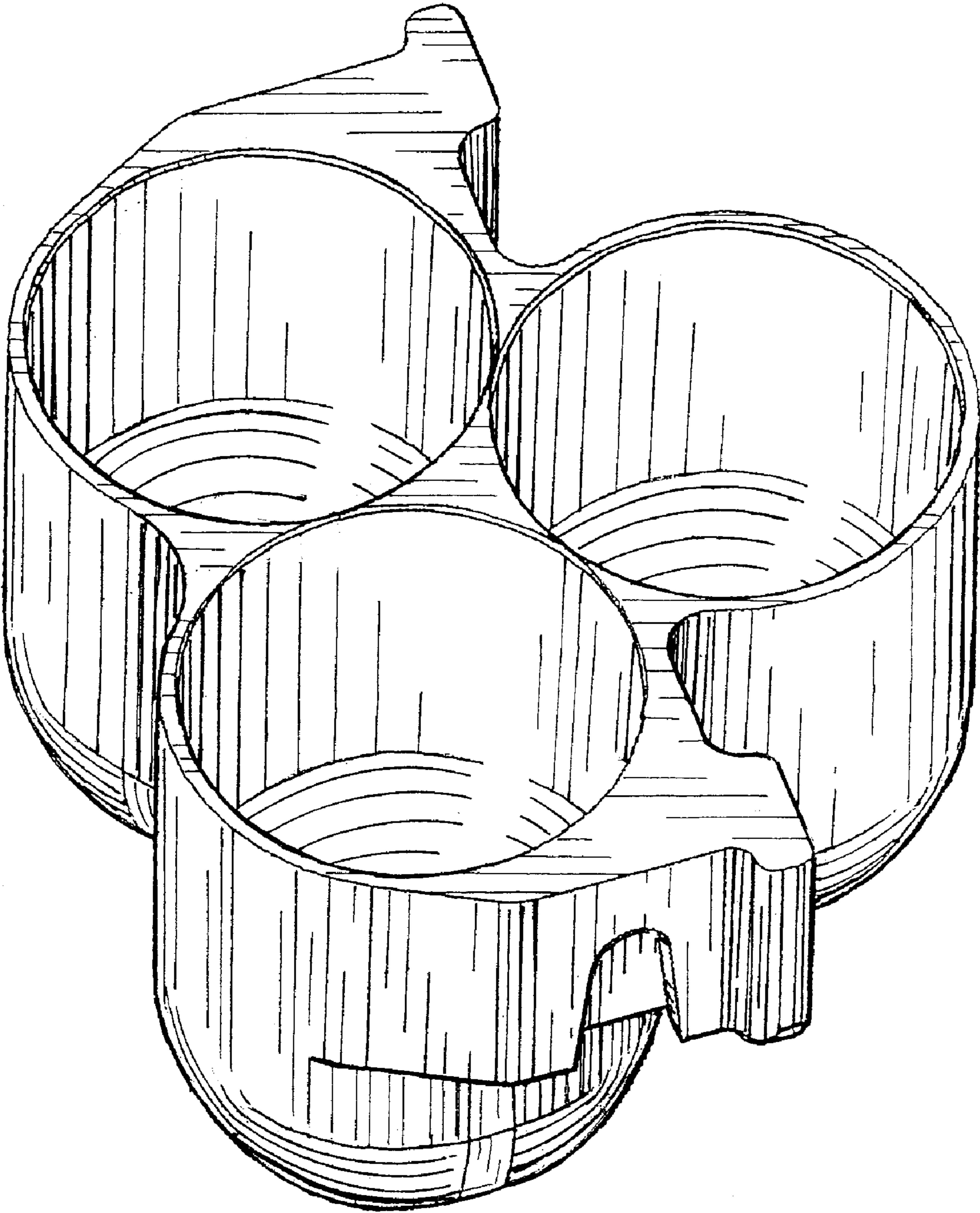

Fig. 1



*Fig. 2*

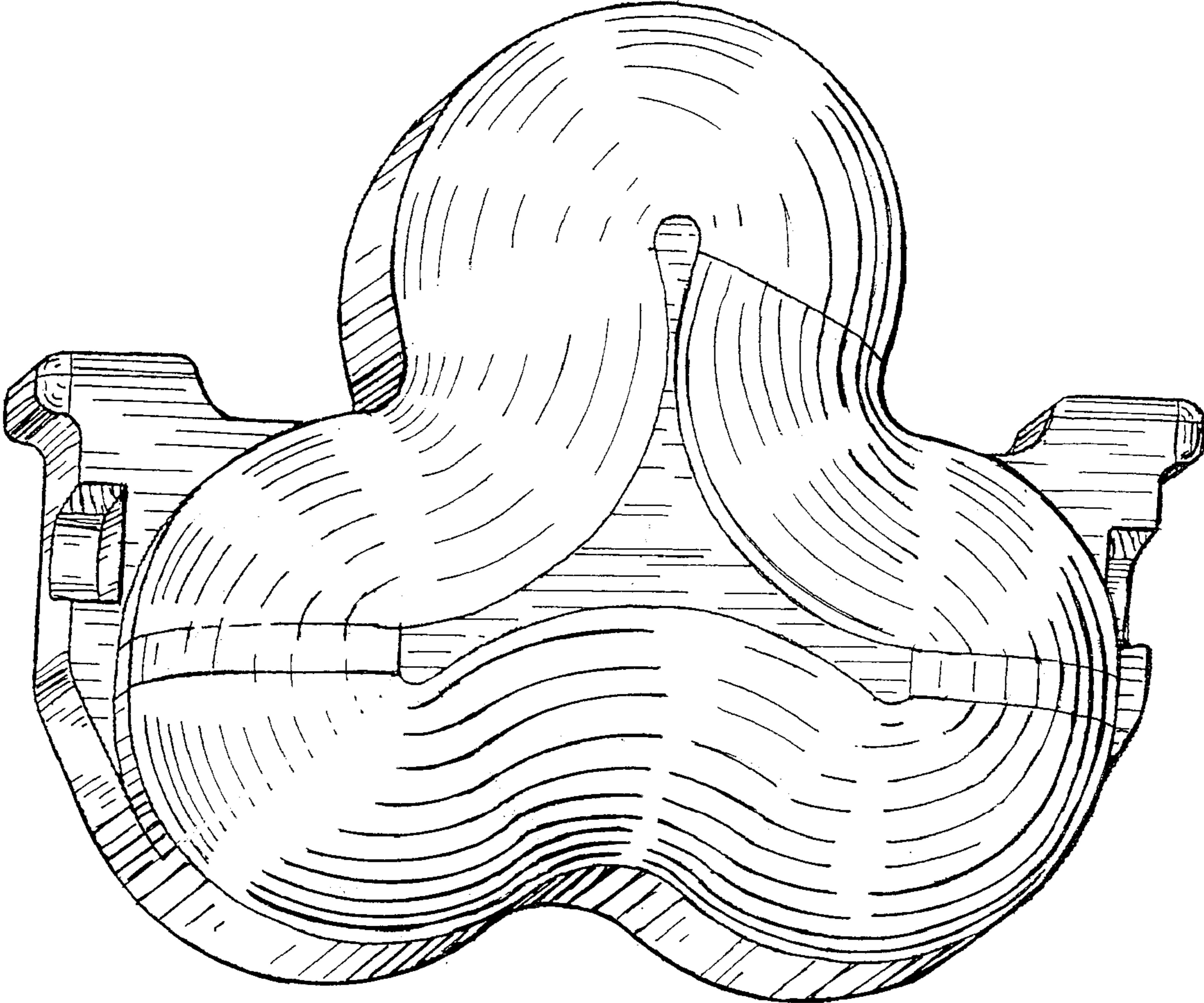
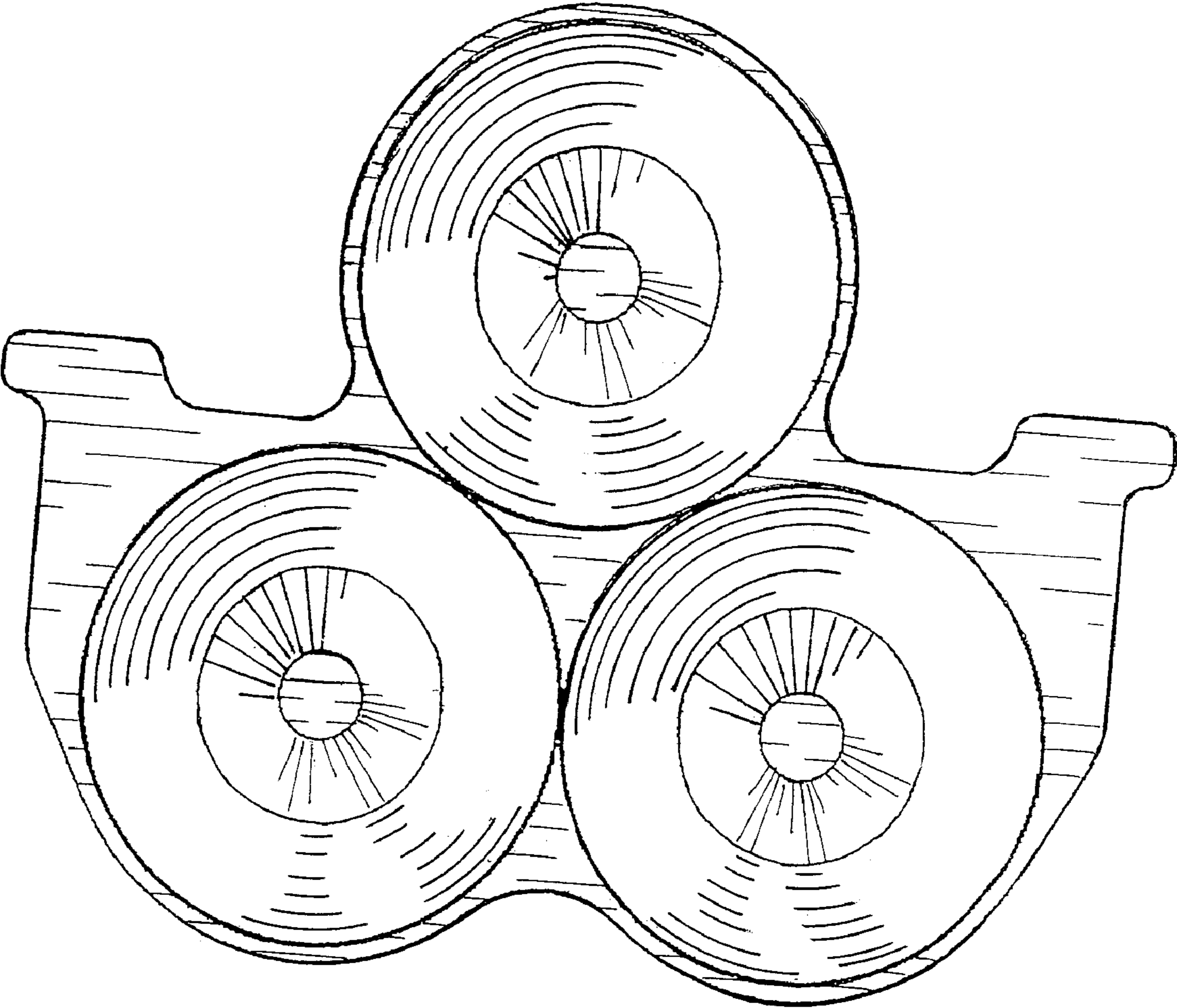
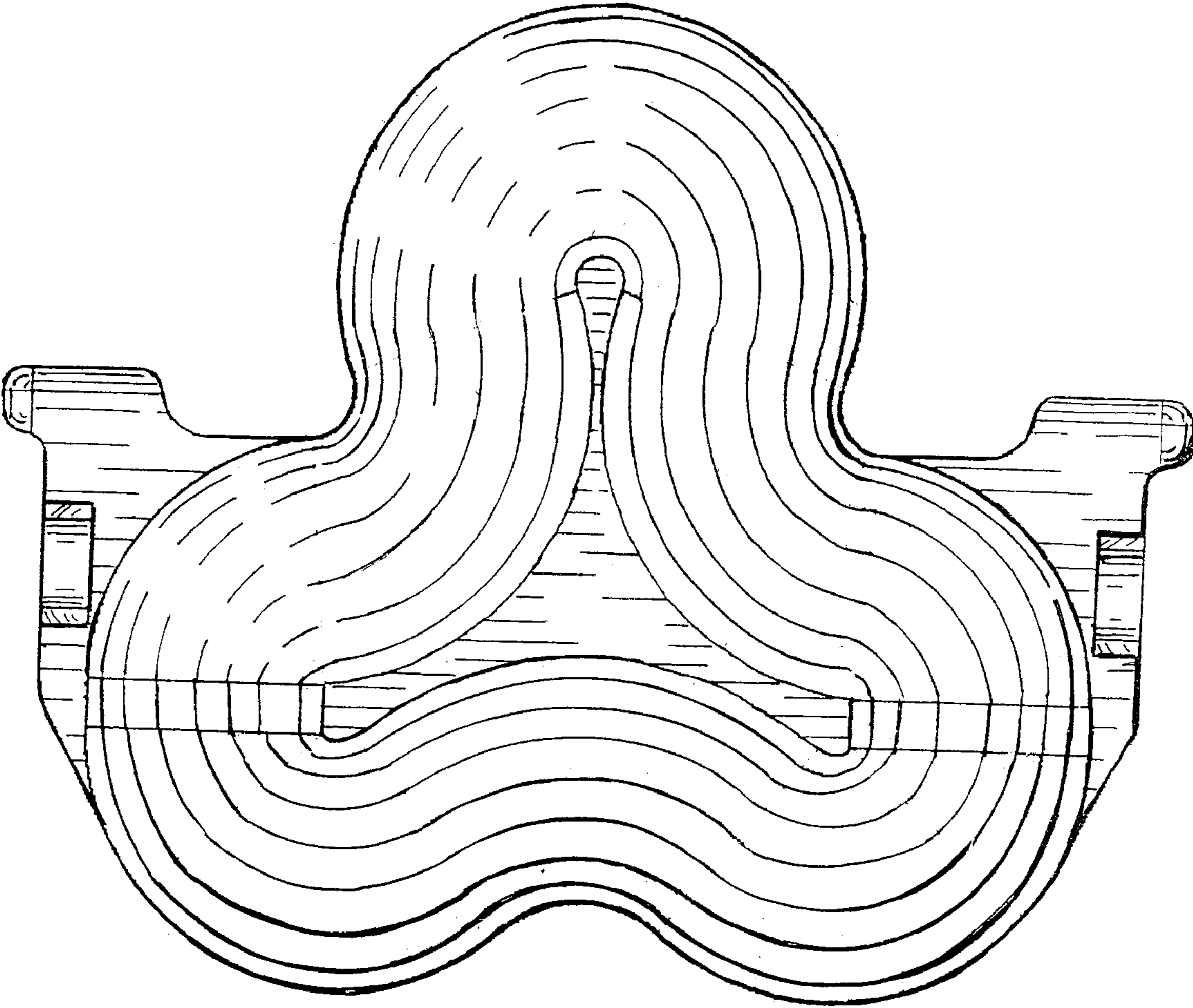

Fig. 3



*Fig. 4*



*Fig. 5*

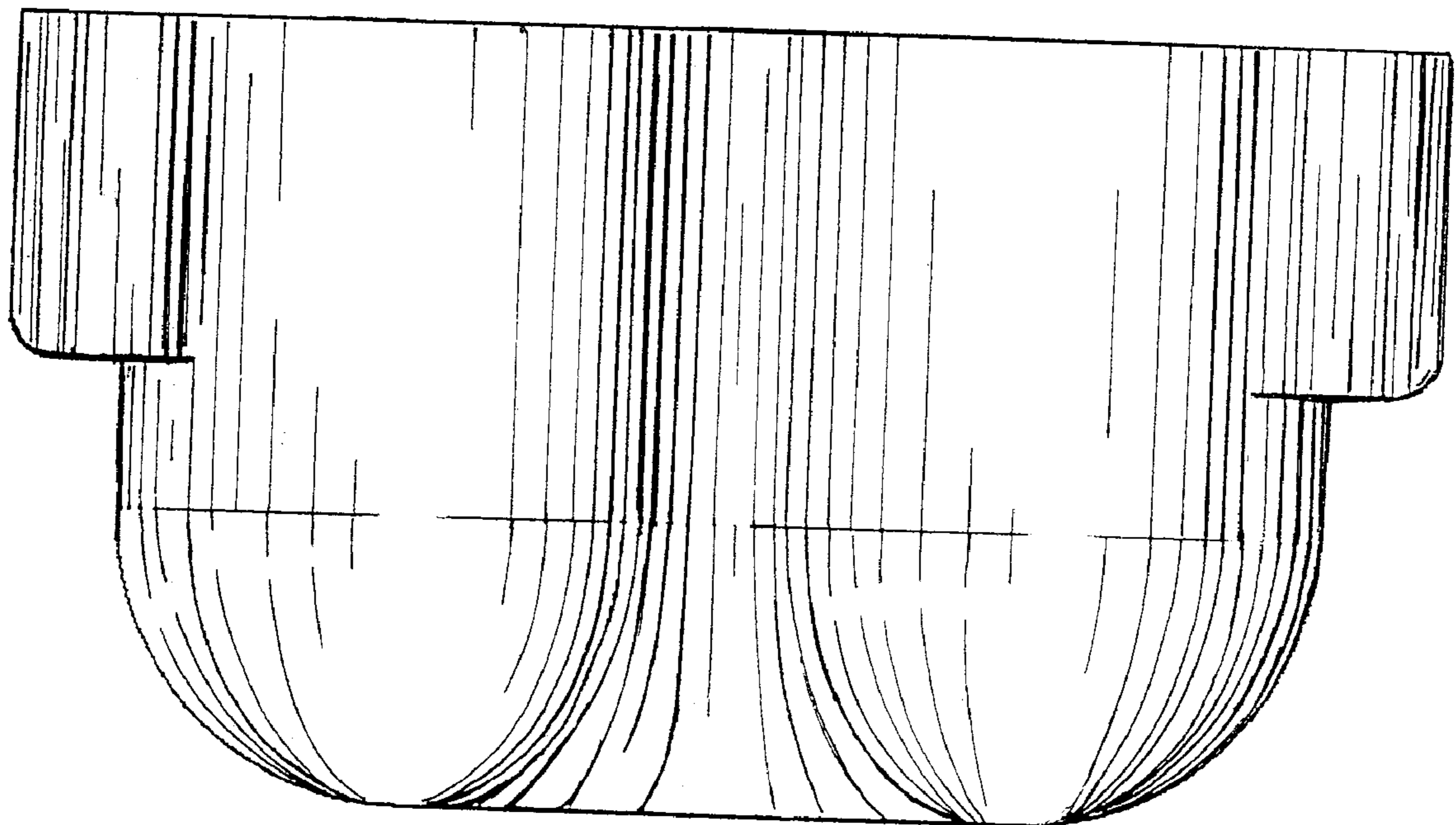

*Fig. 6*

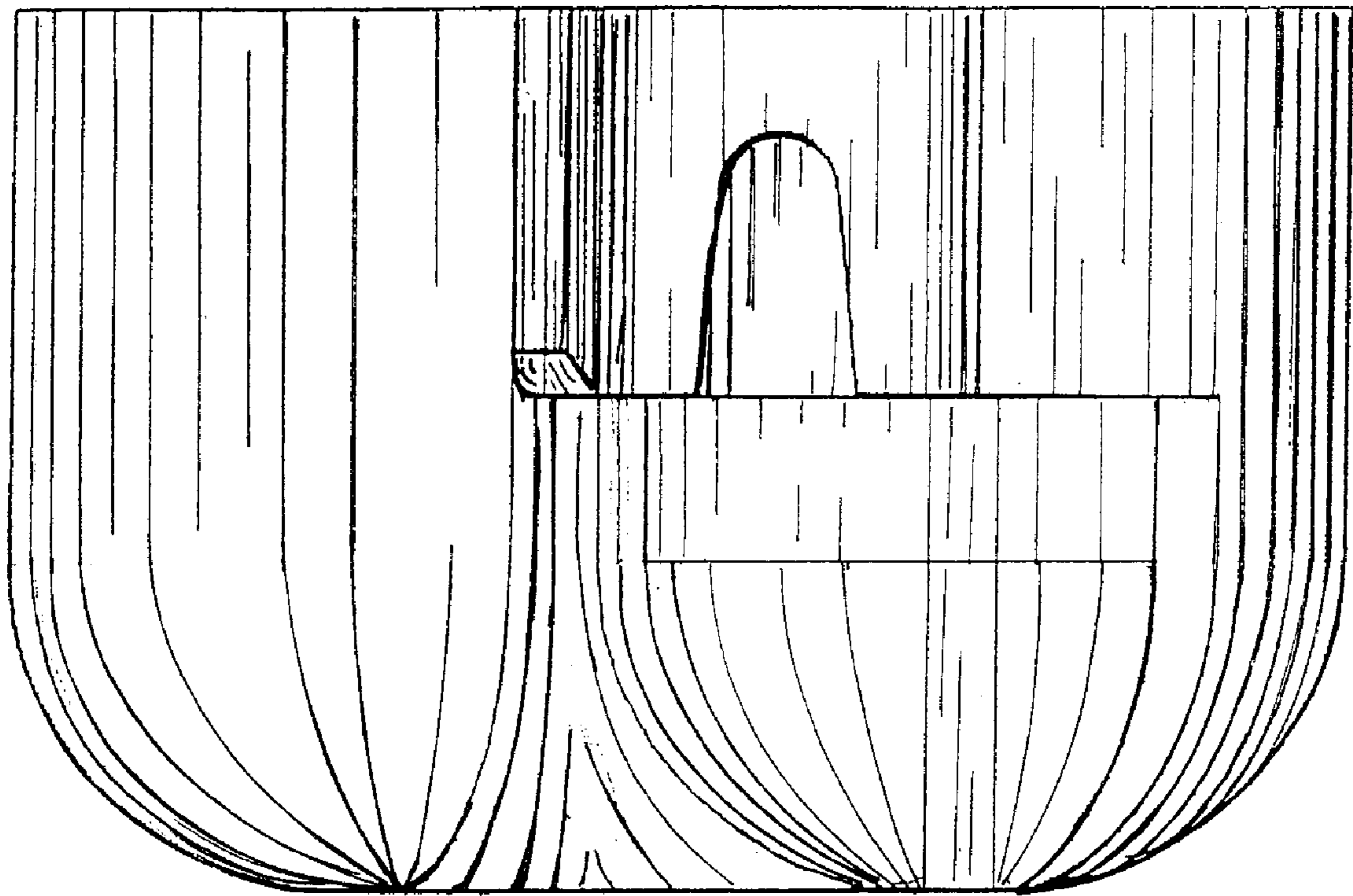

*Fig. 7*