

US00D501557S

(12) **United States Design Patent**
Collins et al.

(10) **Patent No.: US D501,557 S**
(45) **Date of Patent: ** Feb. 1, 2005**

(54) **HEALTH ASSESSMENT KIOSK**

2003/0097280 A1 * 5/2003 Fitzpatrick et al. 705/2

(76) Inventors: **John Collins**, 300 Elfwood Dr.,
Monrovia, CA (US) 91016;
Christopher L. Kavars, 708 Woodland
Dr., Elkader, IA (US) 52043; **Leslie G.
Davis**, 304 E. Bridge St., Elkader, IA
(US) 52043; **Ronald L. Green**, P.O.
Box 688, Elkader, IA (US) 52043

* cited by examiner

Primary Examiner—Stella Reid
(74) *Attorney, Agent, or Firm*—Wood, Phillips, Katz, Clark
& Mortimer

(**) Term: **14 Years**

(57) **CLAIM**

The ornamental design for a health assessment kiosk, as
shown and described.

(21) Appl. No.: **29/176,834**

DESCRIPTION

(22) Filed: **Feb. 27, 2003**

(51) **LOC (7) Cl.** **24-01**

(52) **U.S. Cl.** **D24/186**

(58) **Field of Search** D24/186; 128/920,
128/921, 923; 600/300, 301, 481, 529,
533

FIG. 1 is a front, top and side perspective view of a health
assessment kiosk, showing our new design;
FIG. 2 is a front elevation view thereof;
FIG. 3 is a rear elevation view thereof;
FIG. 4 is an elevation view thereof from the side opposite
that in FIG. 1;
FIG. 5 is an elevation view thereof from the same side as in
FIG. 1;
FIG. 6 is a top plan view thereof; and,
FIG. 7 is a bottom plan view thereof.

The portions of the health assessment kiosk shown in broken
lines is for illustrative purposes only and form no part of the
claimed design.

(56) **References Cited**

U.S. PATENT DOCUMENTS

4,981,139 A	*	1/1991	Pfohl	600/484
D328,645 S	*	8/1992	Rogler et al.	D24/186
D395,513 S	*	6/1998	Rogler	D24/186
D404,816 S	*	1/1999	Tsuan	D24/186
D412,748 S	*	8/1999	Nabarro	D24/186

1 Claim, 4 Drawing Sheets

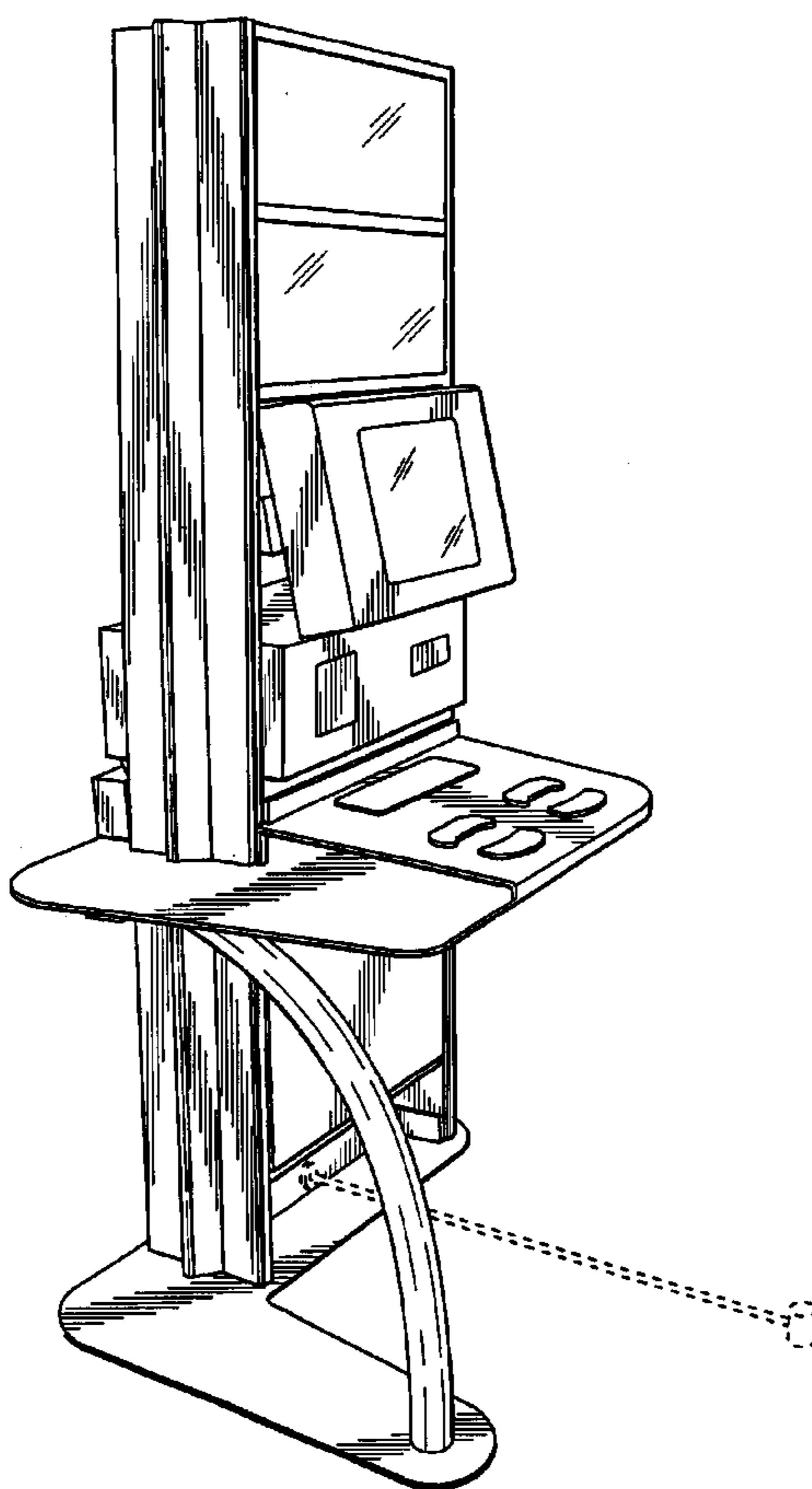

Fig. 1

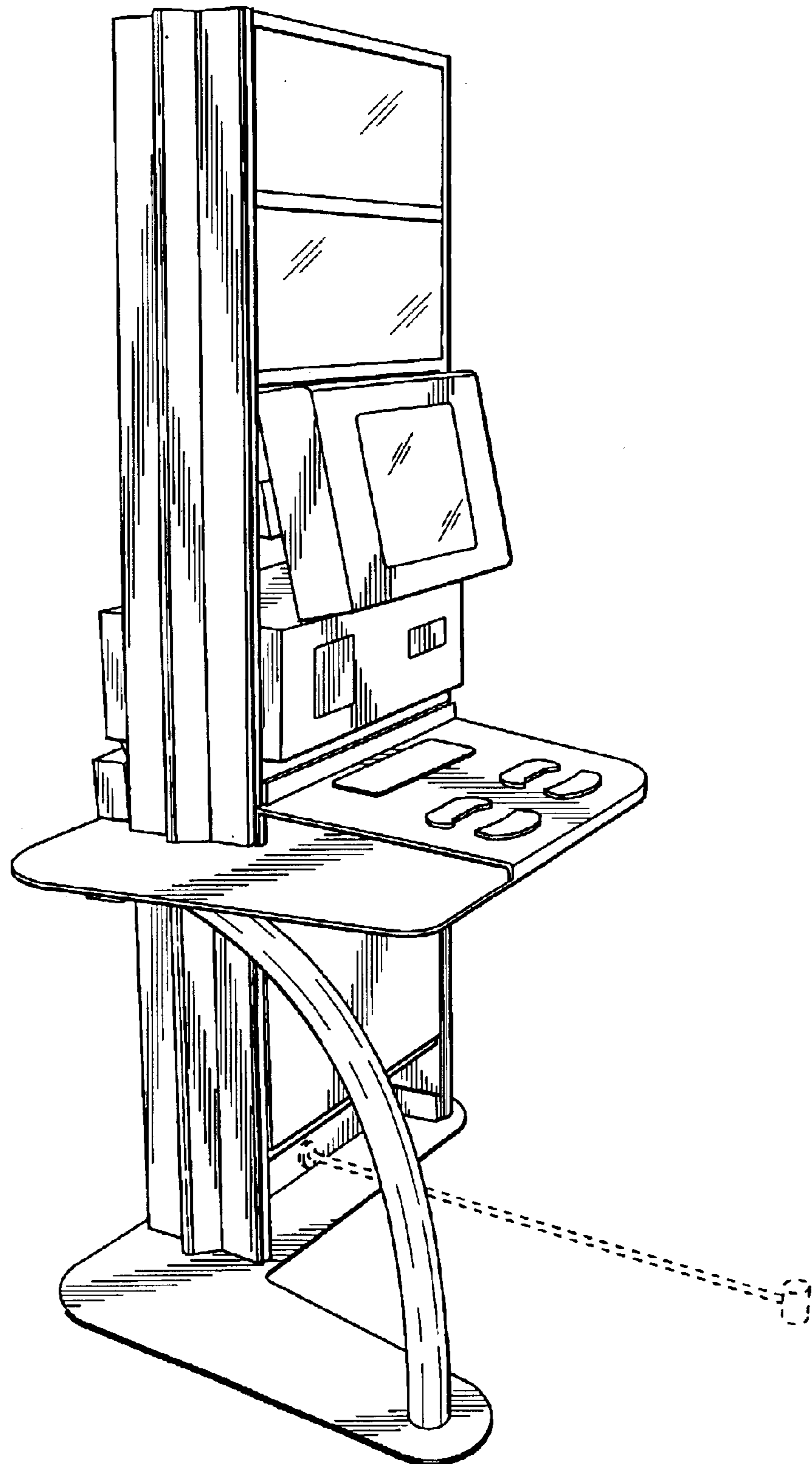

Fig. 2

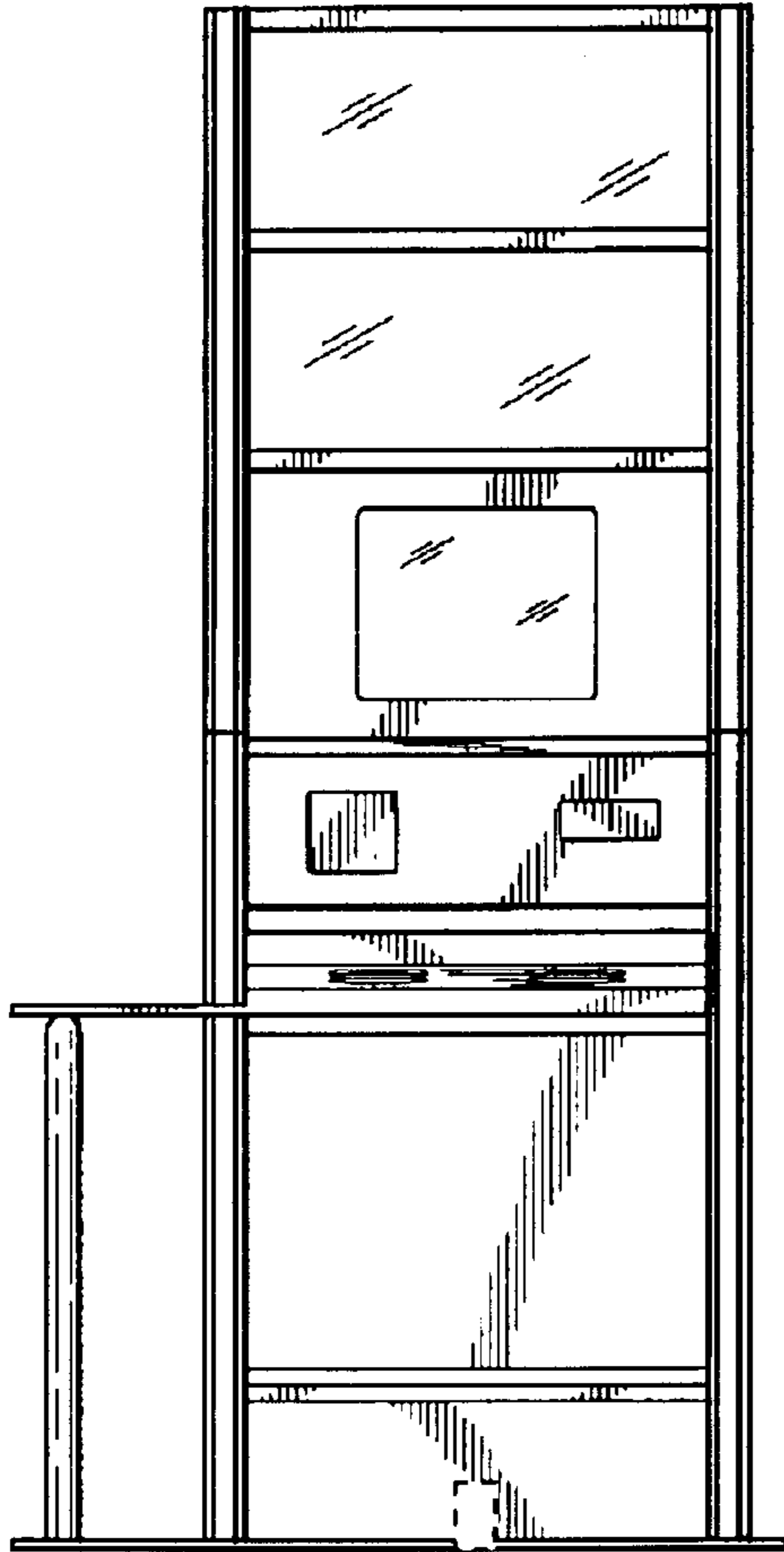

Fig. 3

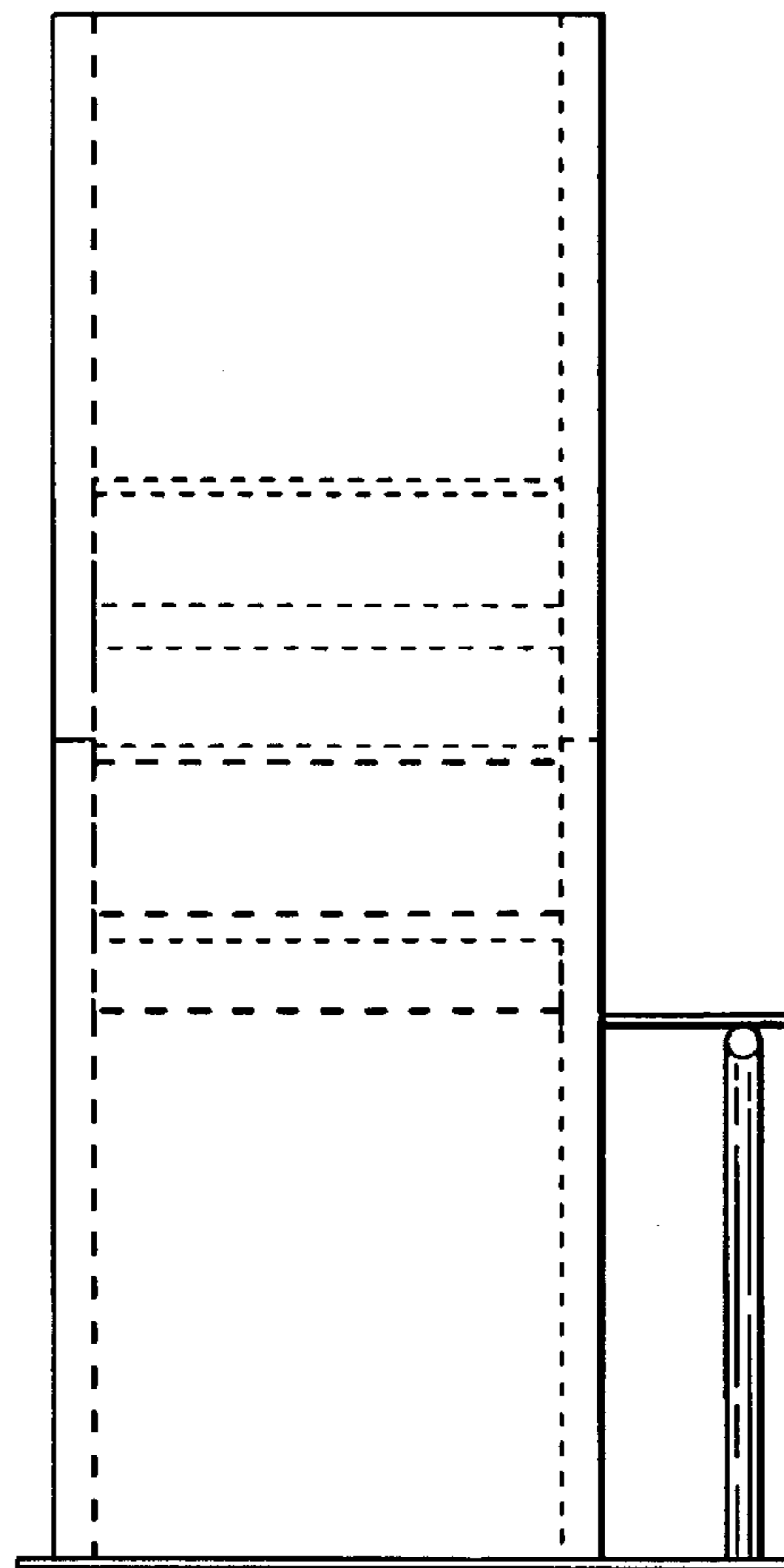

Fig. 4

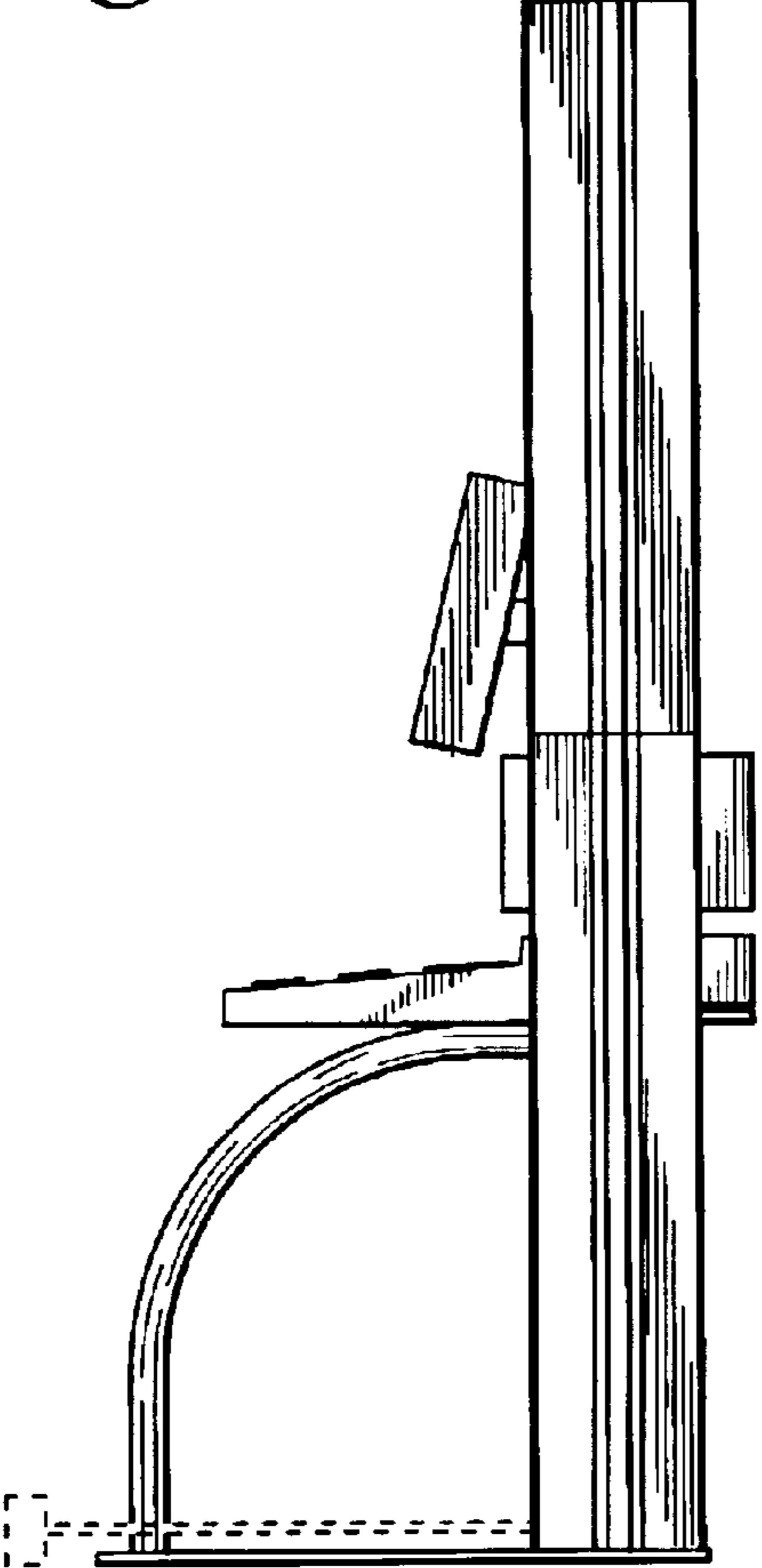

Fig. 5

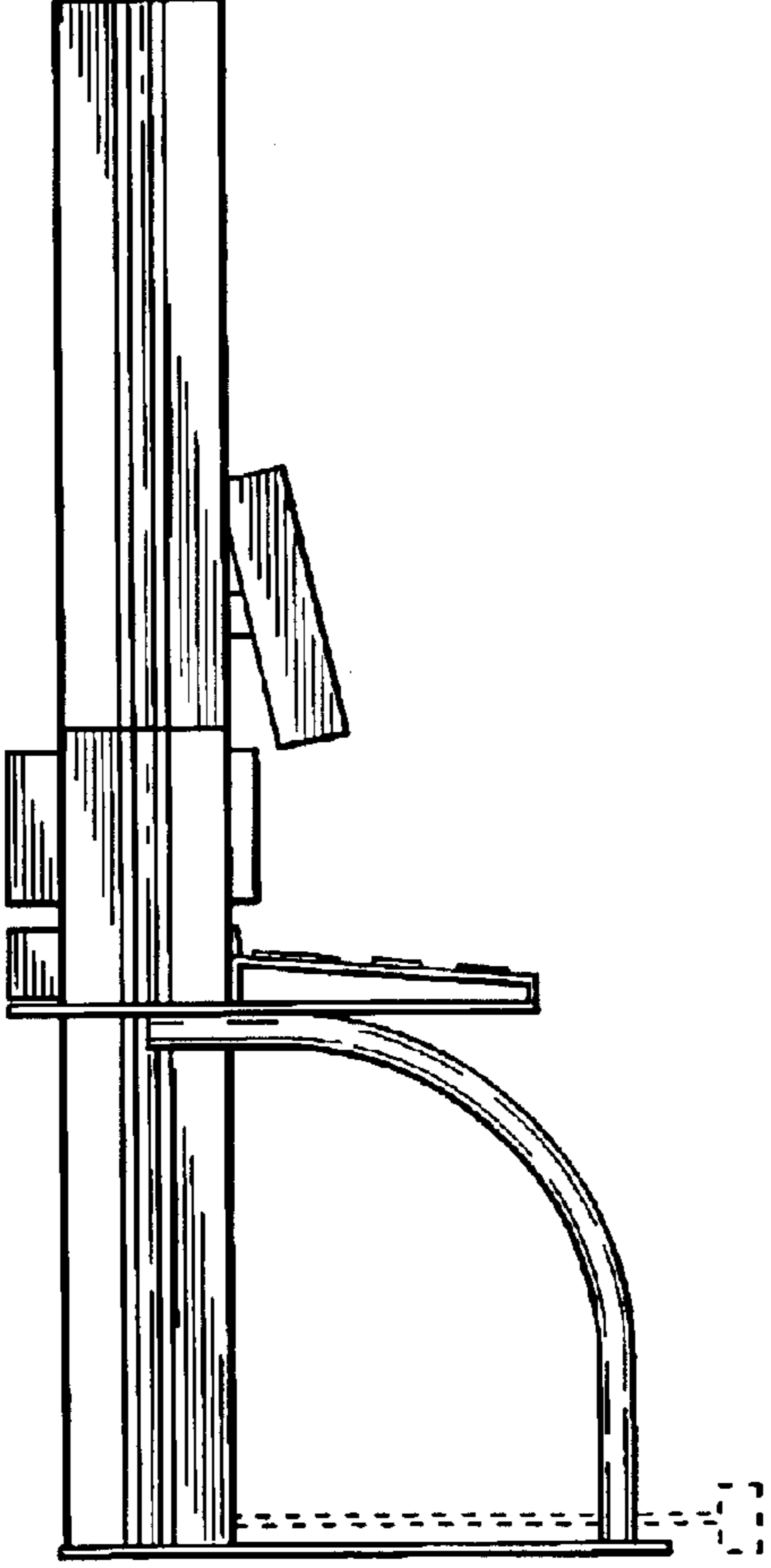

Fig. 6

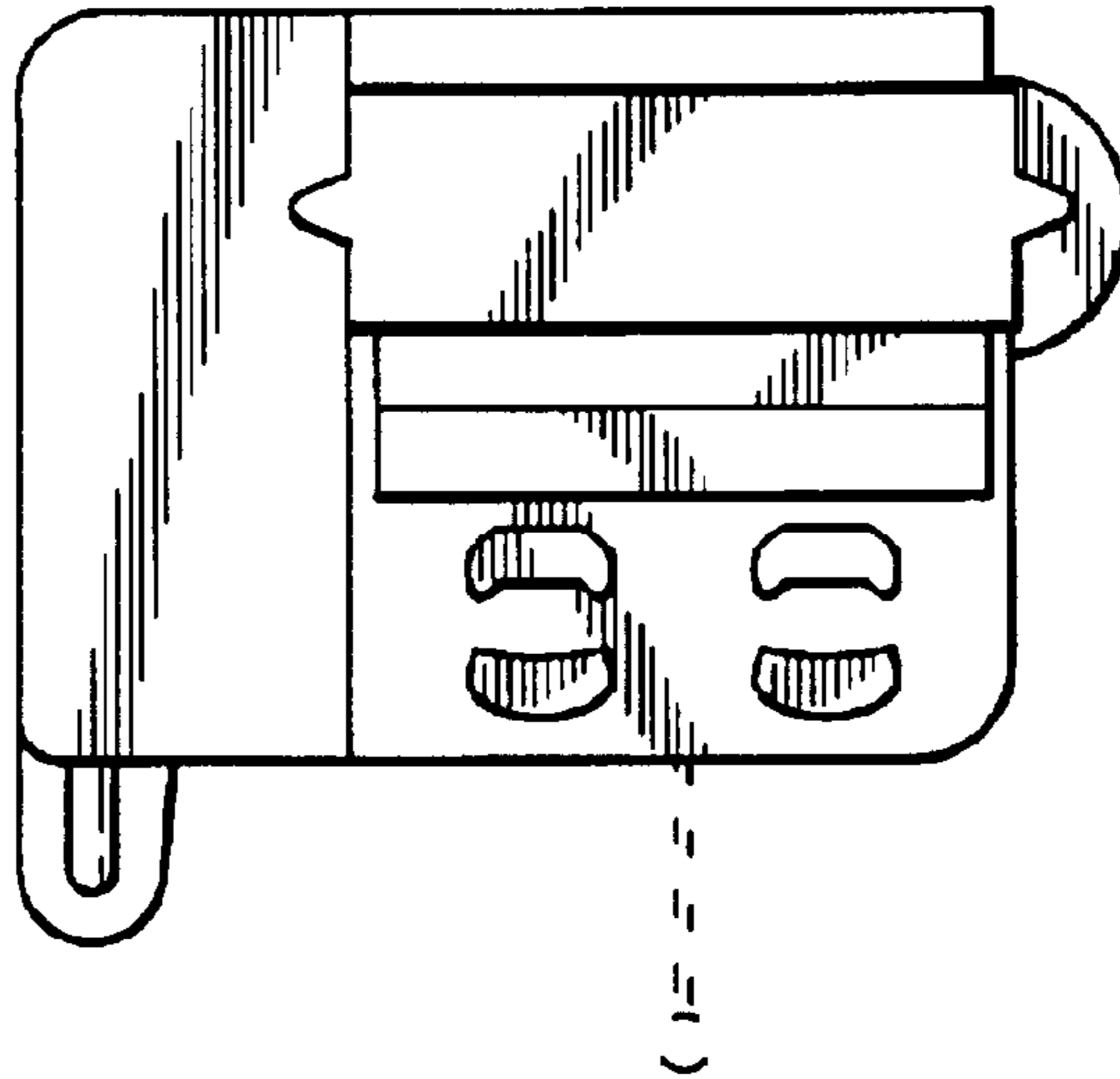

Fig. 7

