

US00D501414S

(12) **United States Design Patent**
Graef et al.

(10) **Patent No.:** **US D501,414 S**

(45) **Date of Patent:** **** Feb. 1, 2005**

(54) **MEASUREMENT INSTRUMENT**

(75) Inventors: **David Graef**, Campbell Hall, NY (US);
Phil Stearns, Colorado Springs, CO
(US); **Norio Shimomura**, Tokyo (JP);
Satoshi Hayasaka, Tokyo (JP)

(73) Assignee: **LeCroy Corporation**, Chestnut Ridge,
NY (US)

(**) Term: **14 Years**

(21) Appl. No.: **29/191,579**

(22) Filed: **Oct. 9, 2003**

(51) **LOC (7) Cl.** **10-04**

(52) **U.S. Cl.** **D10/76**

(58) **Field of Search** D10/76; 702/189,
702/65, 125, 66-68; 324/555; 345/440,
175, 173, 440.1

(56) **References Cited**

U.S. PATENT DOCUMENTS

6,720,776 B2 * 4/2004 Anderson et al. 324/555

2001/0001850 A1 * 5/2001 Miller 702/67
2003/0191591 A1 * 10/2003 Iiyoshi et al. 702/68
2003/0204342 A1 * 10/2003 Law et al. 29/191

* cited by examiner

Primary Examiner—Antoine D. Davis

(74) *Attorney, Agent, or Firm*—Frommer Lawrence &
Haug LLP; William S. Frommer

(57) **CLAIM**

The ornamental design for the “measurement instrument,”
as shown.

DESCRIPTION

FIG. 1 is a front elevational view of a first embodiment of
the measurement instrument showing our new design;
FIG. 2 is a top plan view thereof;
FIG. 3 is a left side elevational view thereof;
FIG. 4 is a right side elevational view thereof;
FIG. 5 is a rear elevational view thereof; and,
FIG. 6 is a bottom plan view thereof.

The broken line showing is for illustrative purposes only and
forms no part of the claimed design.

1 Claim, 6 Drawing Sheets

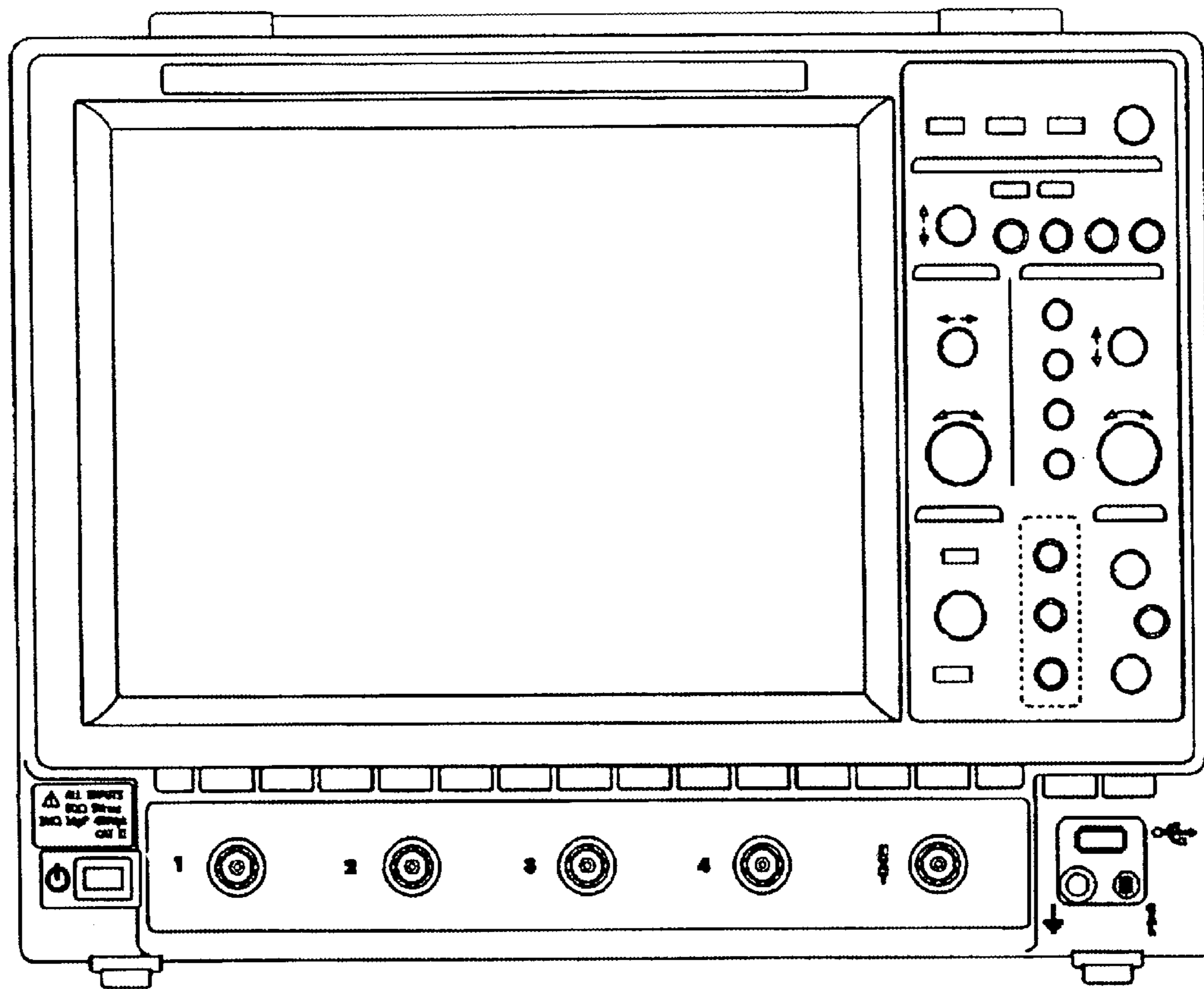

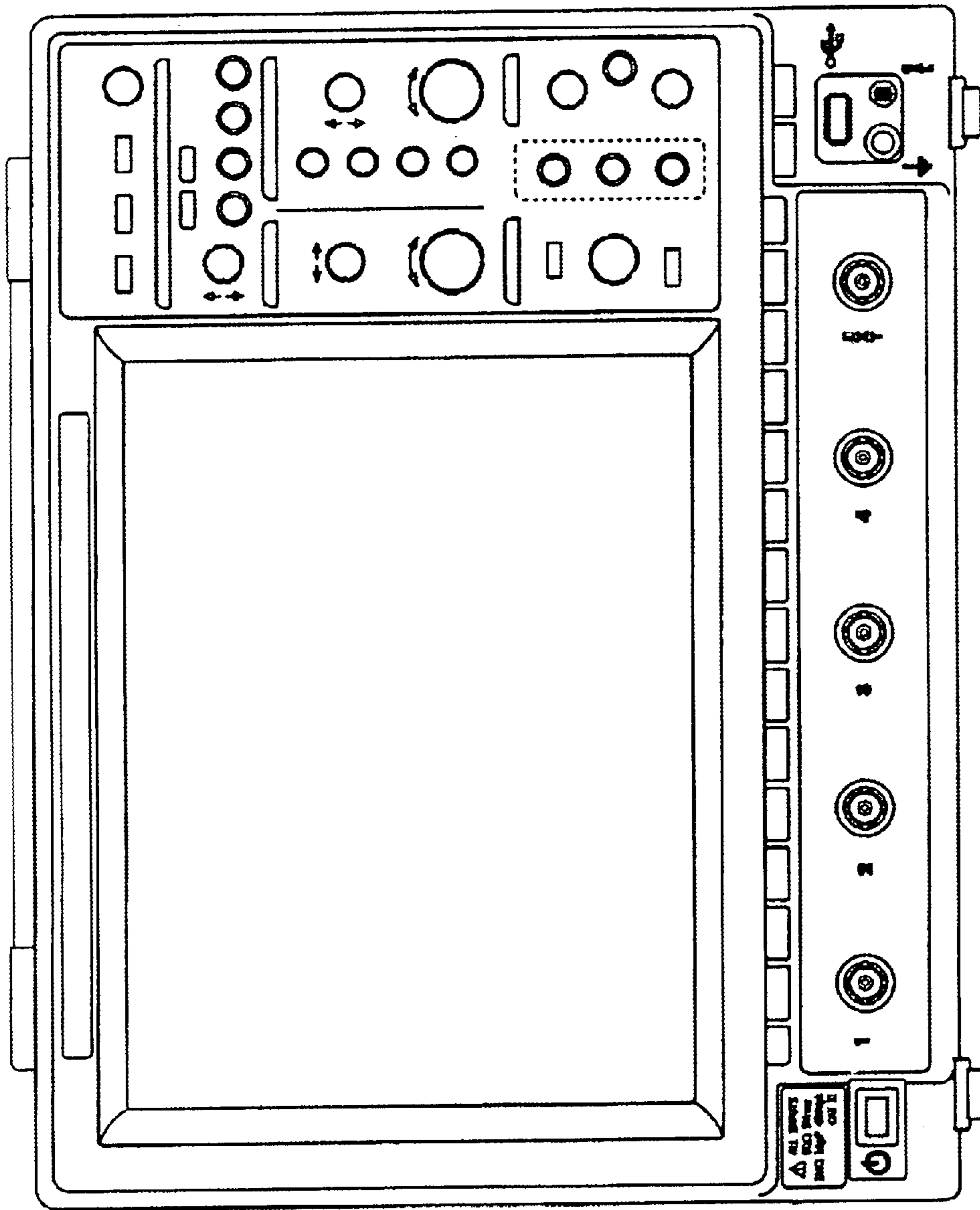

FIG. 1

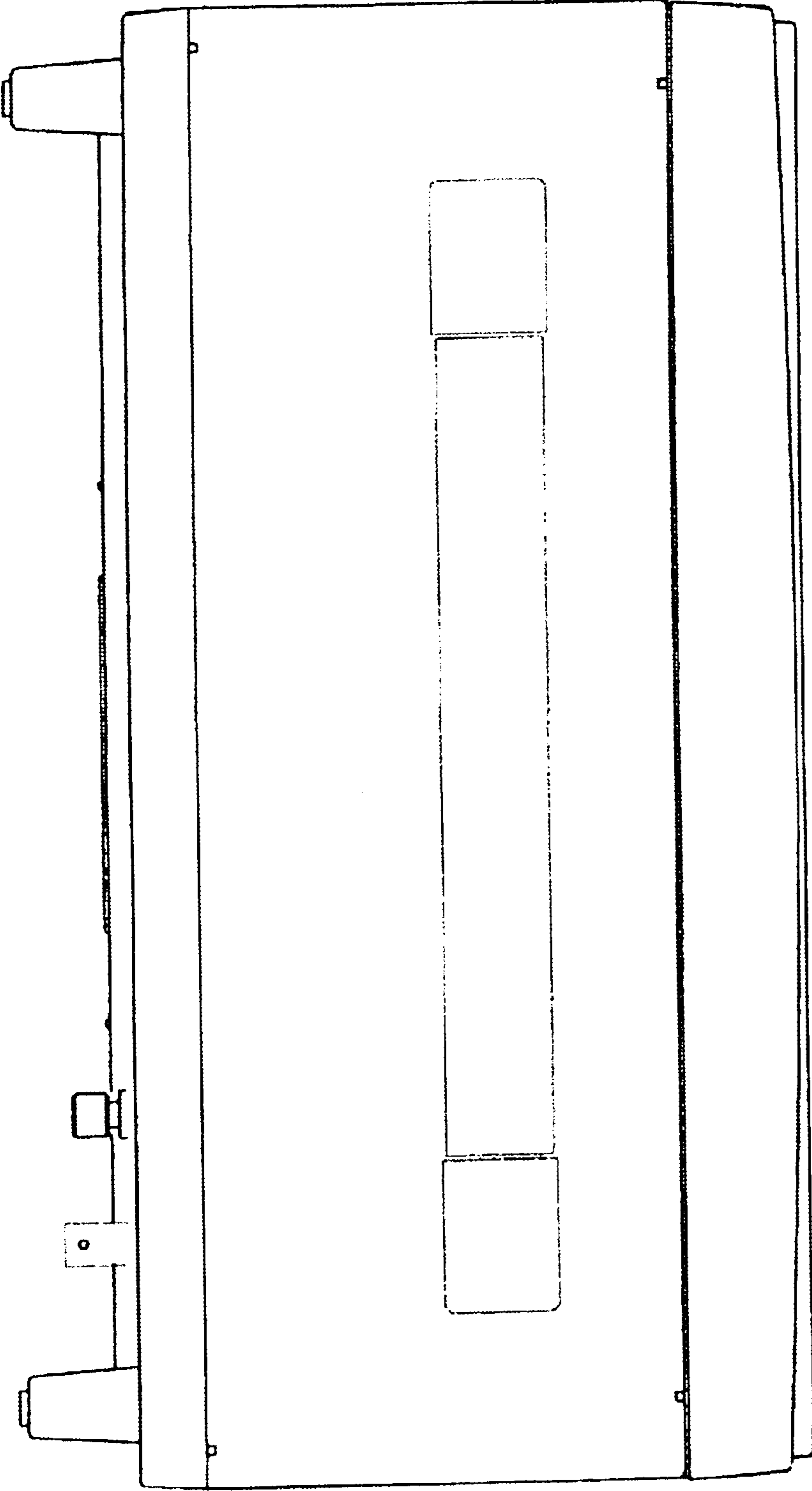

FIG. 2

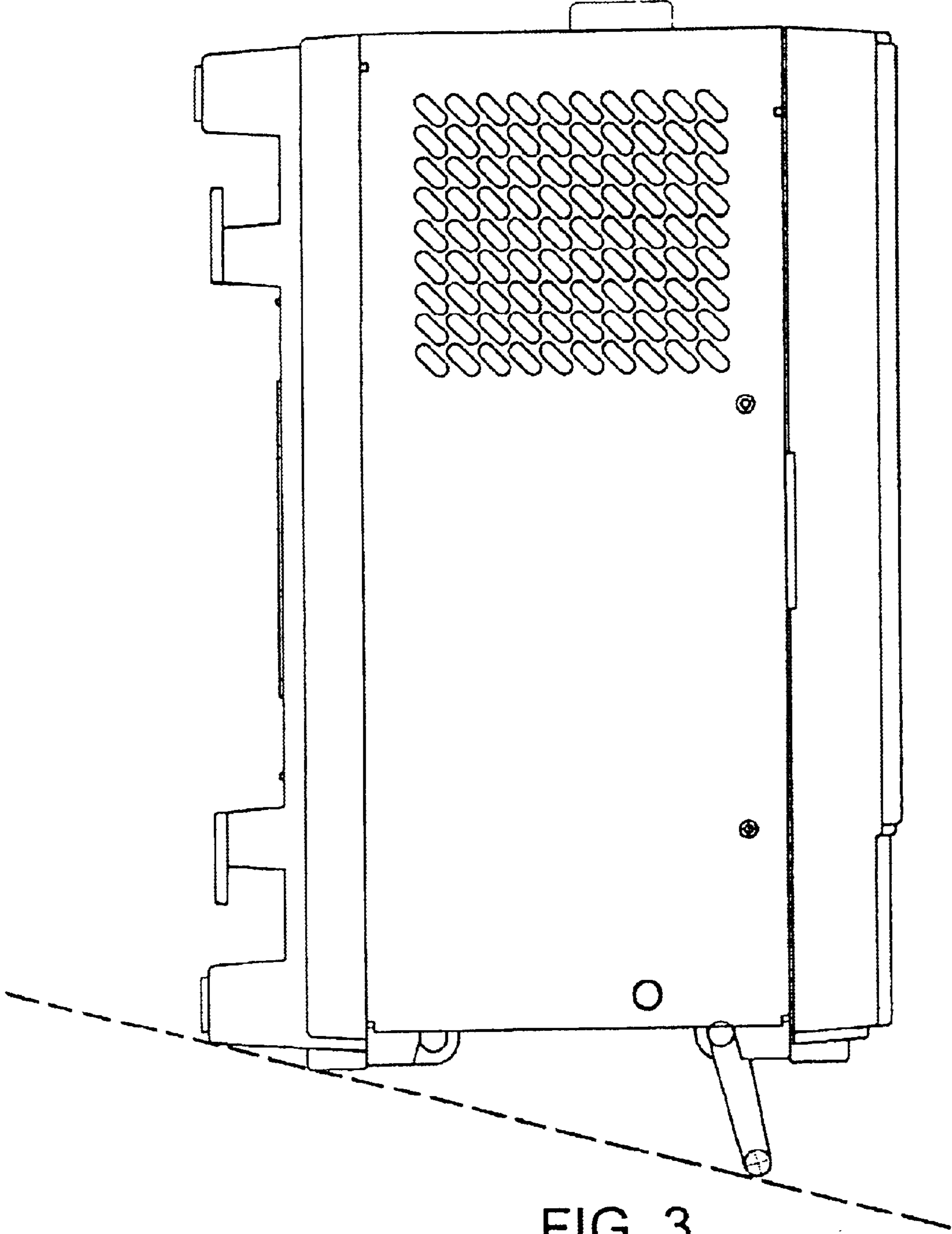

FIG. 3

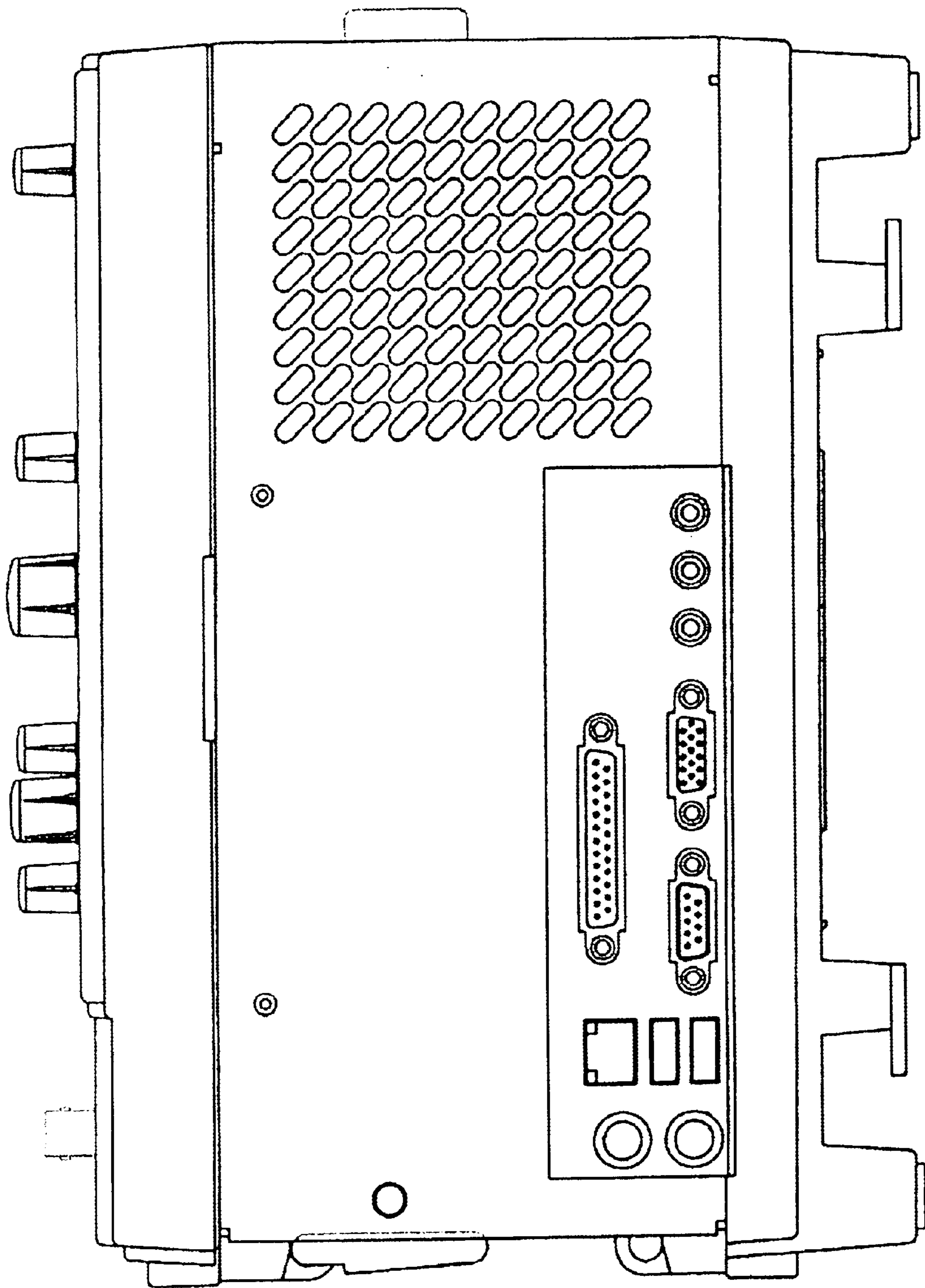

FIG. 4

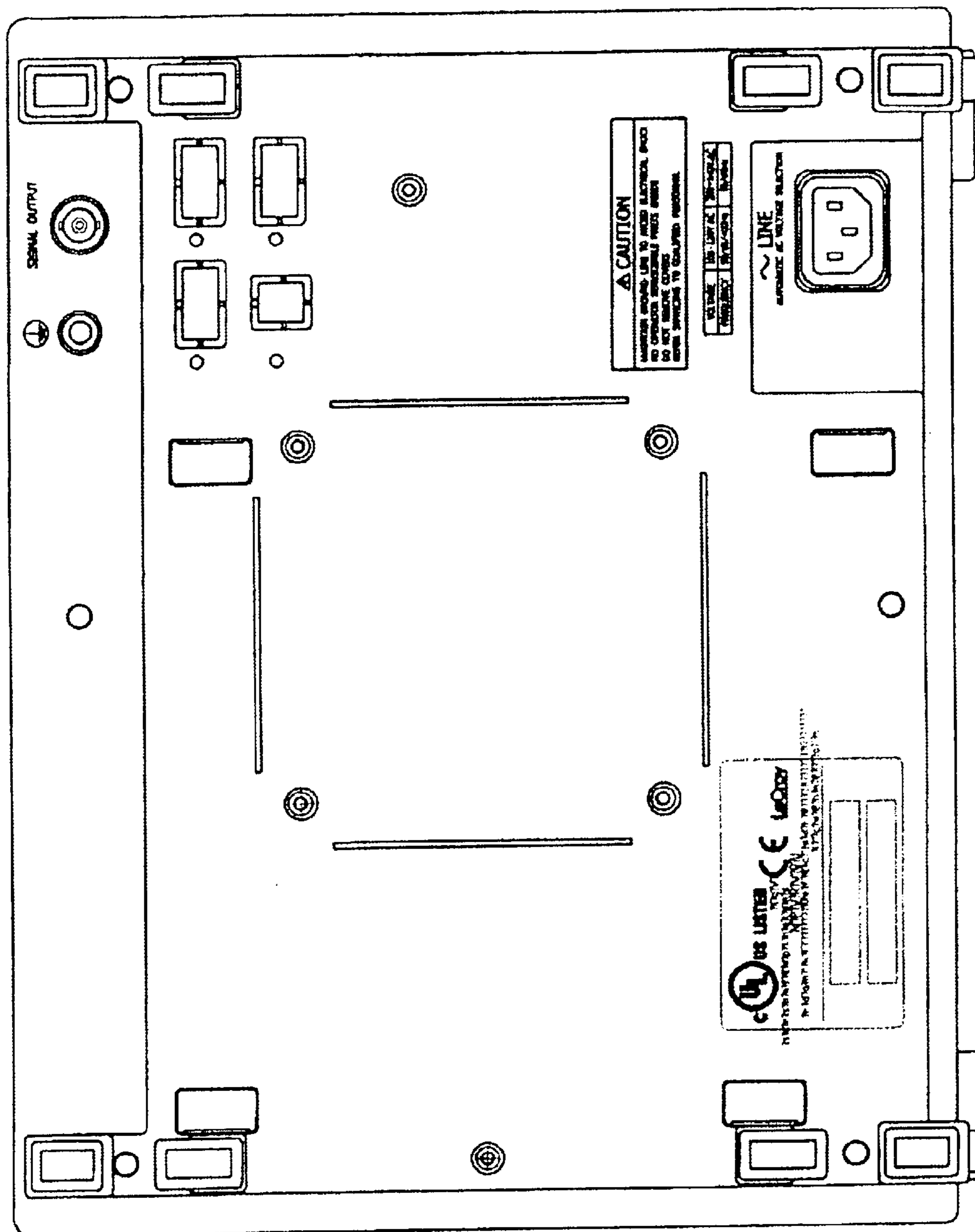

FIG. 5

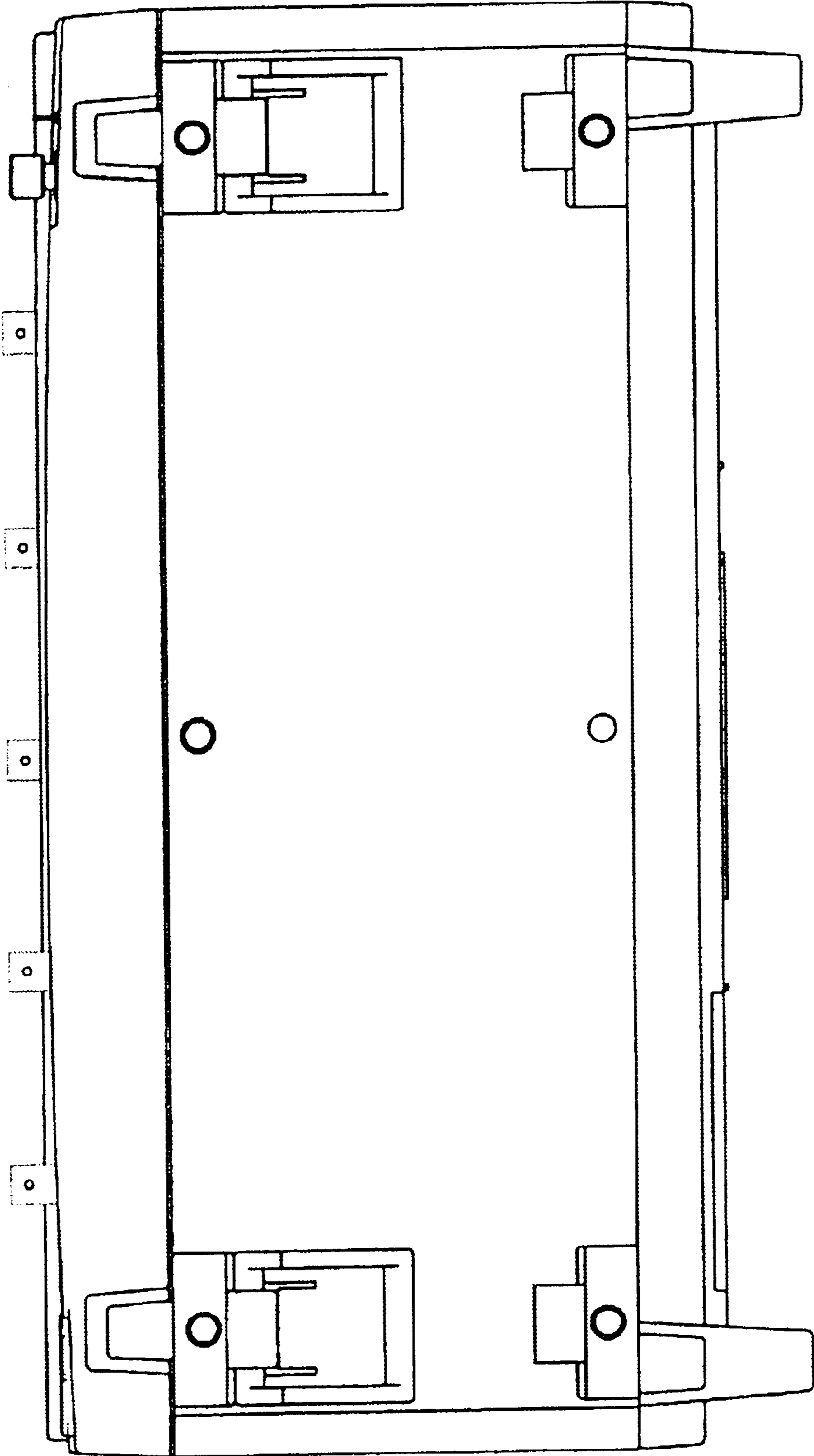

FIG. 6