



US00D501407S

(12) **United States Design Patent**
Feen

(10) **Patent No.:** **US D501,407 S**

(45) **Date of Patent:** **** Feb. 1, 2005**

(54) **CONTAINER**

(75) **Inventor:** **Stuart Feen, Grayslake, IL (US)**

(73) **Assignee:** **Plastic Bottle Corporation,
Libertyville, IL (US)**

(**) **Term:** **14 Years**

(21) **Appl. No.:** **29/179,901**

(22) **Filed:** **Apr. 16, 2003**

(51) **LOC (7) Cl.** **09-03**

(52) **U.S. Cl.** **D9/528**

(58) **Field of Search** D9/516, 517, 523,
D9/528, 531, 543, 563, 568, 569, 570,
572, 575, 499; 206/527, 822; 215/40, 200,
316, 329, 379, 382, 383, 400; 220/200,
260, 660, 669

(56) **References Cited**

U.S. PATENT DOCUMENTS

D188,260 S	*	6/1960	Ray	D9/570
D207,509 S	*	4/1967	Thomka et al.	D9/528
D248,830 S	*	8/1978	Anderson	D9/523
D294,557 S	*	3/1988	Jones	D9/524
D377,759 S	*	2/1997	Hot	D9/520
D429,644 S	*	8/2000	Hughes	D9/528

D458,541 S	*	6/2002	Steiger et al.	D9/528
D473,794 S	*	4/2003	Ouillet et al.	D9/523

* cited by examiner

Primary Examiner—Stella Reid

Assistant Examiner—Daniel Bui

(74) *Attorney, Agent, or Firm*—Wood, Phillips, Katz, Clark & Mortimer

(57) **CLAIM**

The ornamental design for a container, substantially as shown and described.

DESCRIPTION

FIG. 1 is a perspective view of a container showing my new design;
 FIG. 2 is a front elevational view thereof;
 FIG. 3 is a rear elevational view thereof;
 FIG. 4 is a left side elevational view thereof;
 FIG. 5 is a right side elevational view thereof;
 FIG. 6 is a bottom plan view thereof; and,
 FIG. 7 is a top plan view thereof.
 FIG. 8 is a sectional view taken along line 8-8 in FIG. 2.
 FIG. 9 is a sectional view taken along line 9-9 in FIG. 6.
 FIG. 10 is a sectional view taken along line 10-10 in FIG. 6.

1 Claim, 5 Drawing Sheets

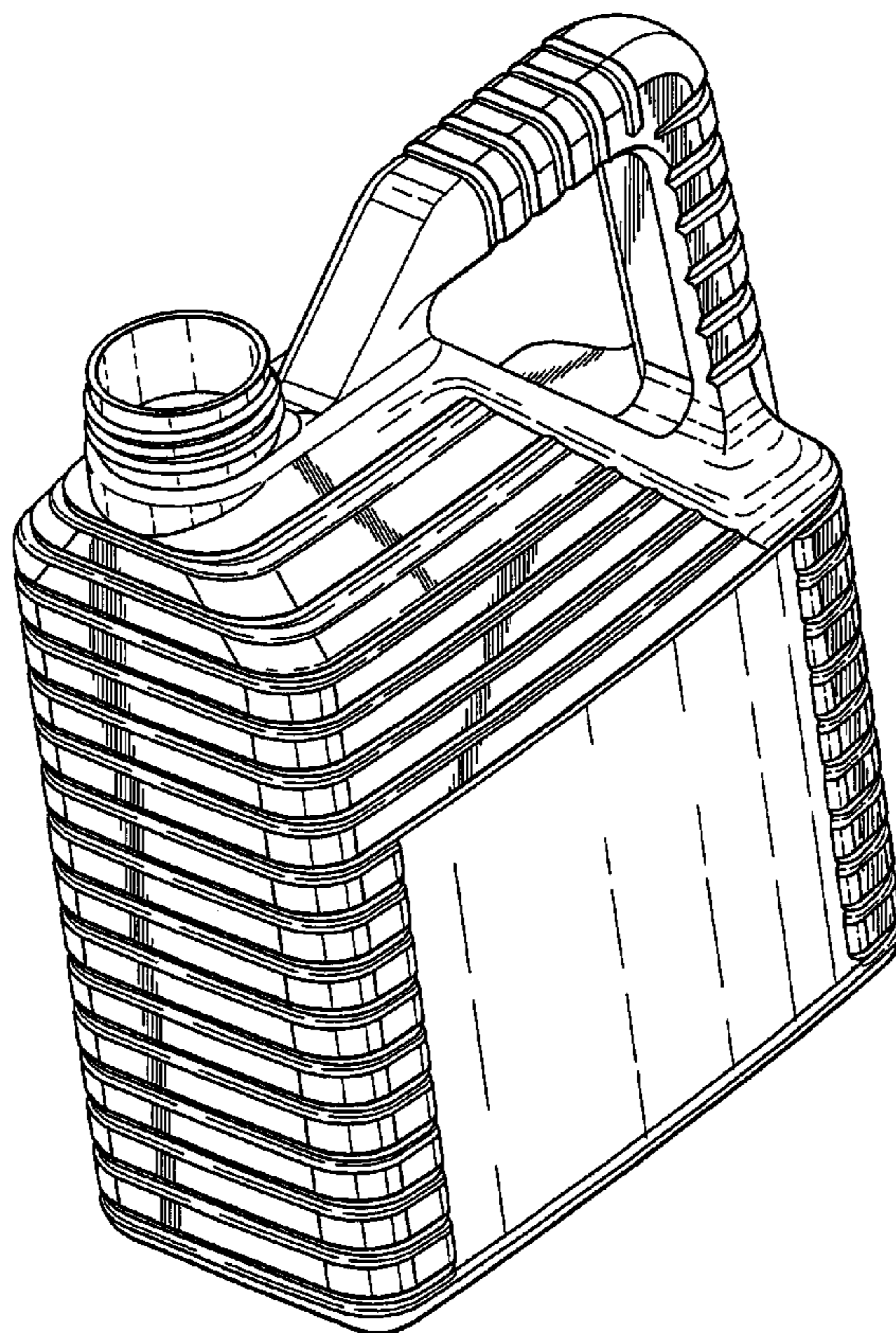

Fig. 1

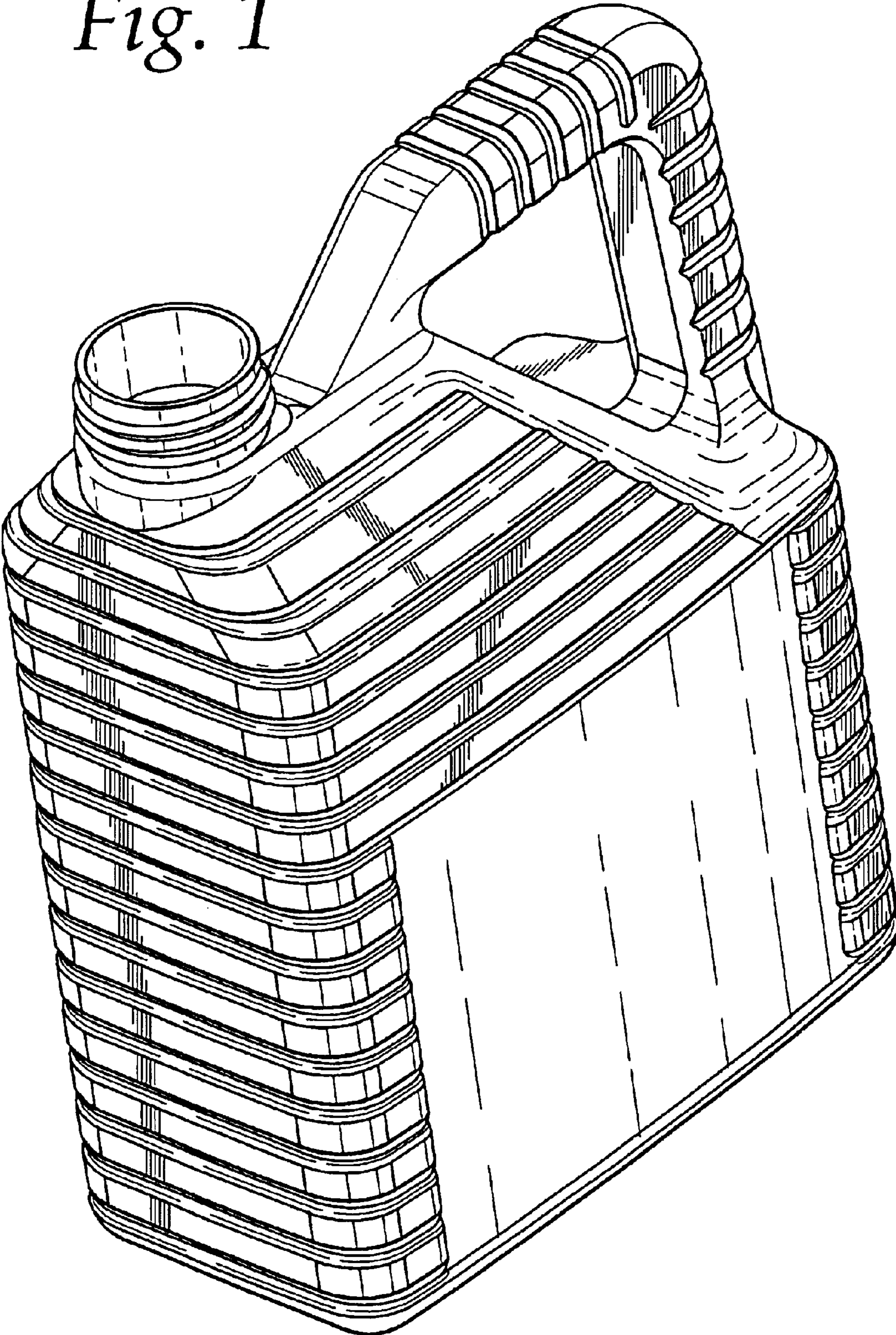

Fig. 2

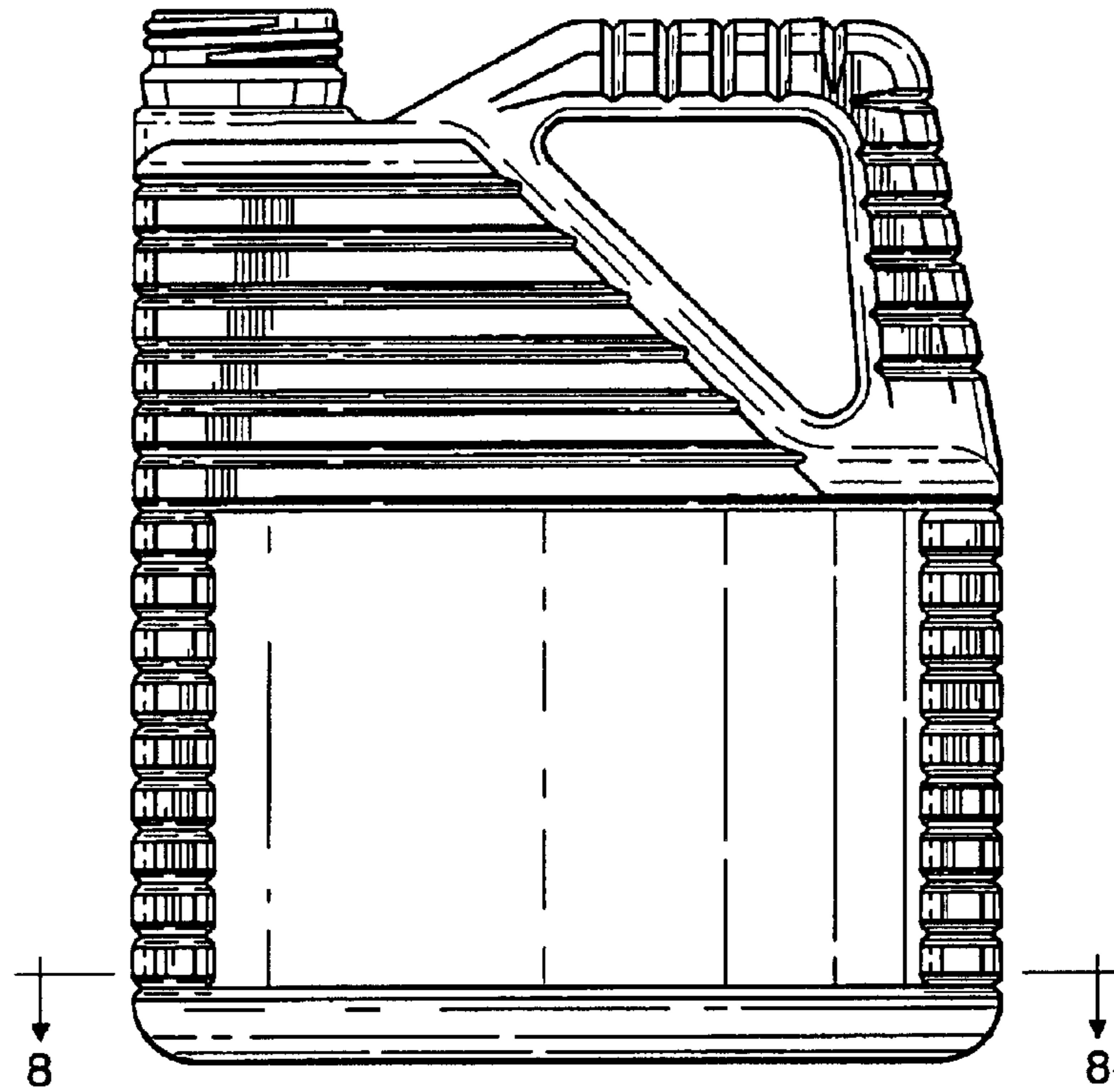

Fig. 3

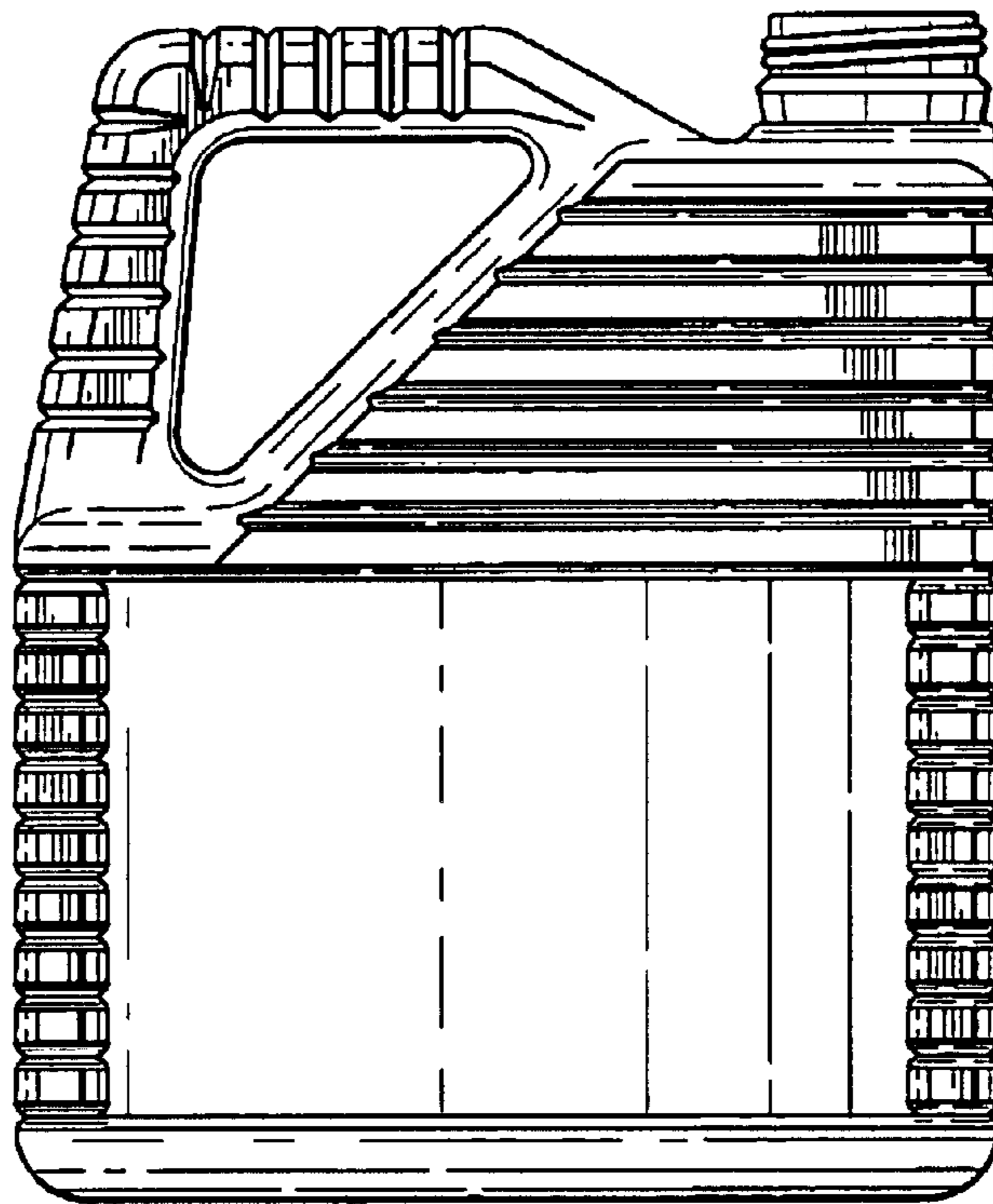

Fig. 4

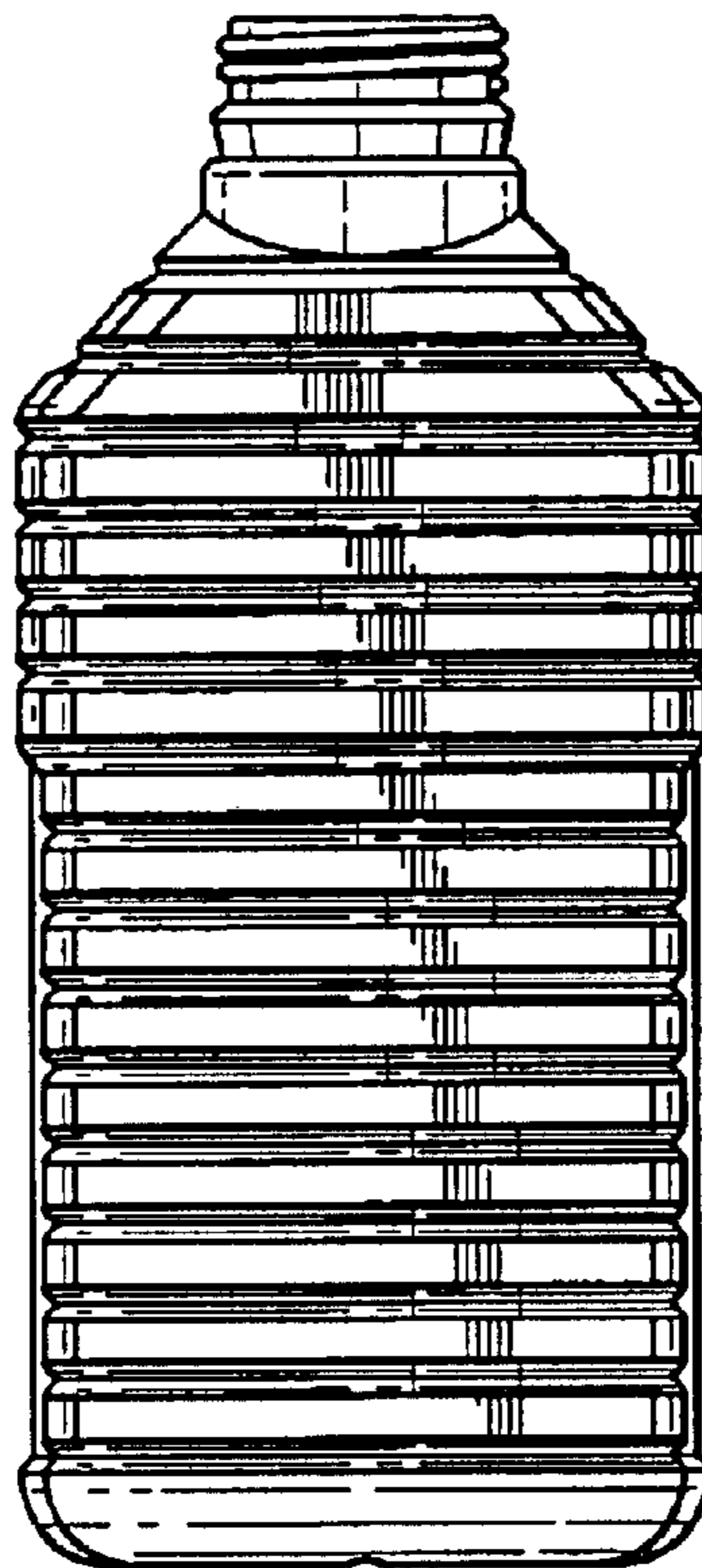

Fig. 5

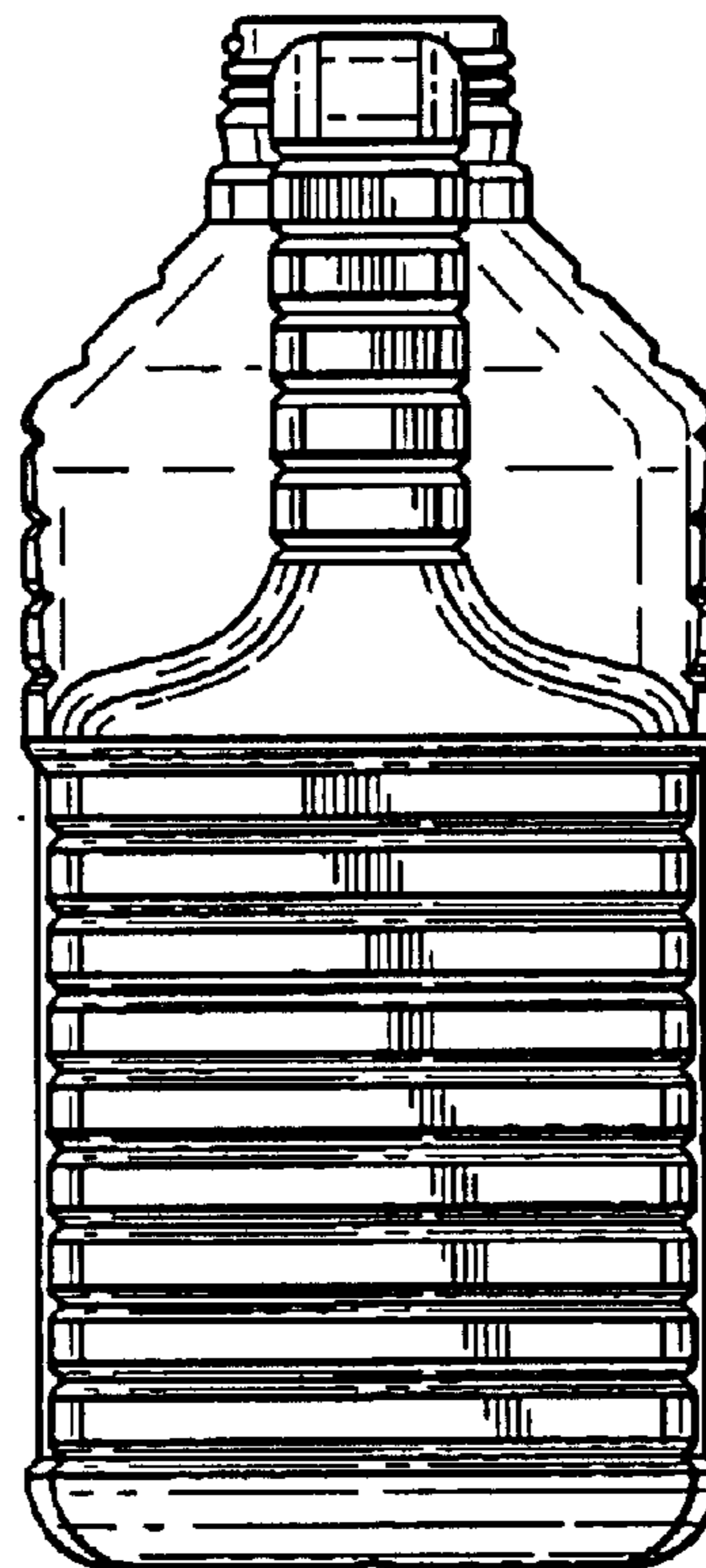

Fig. 6

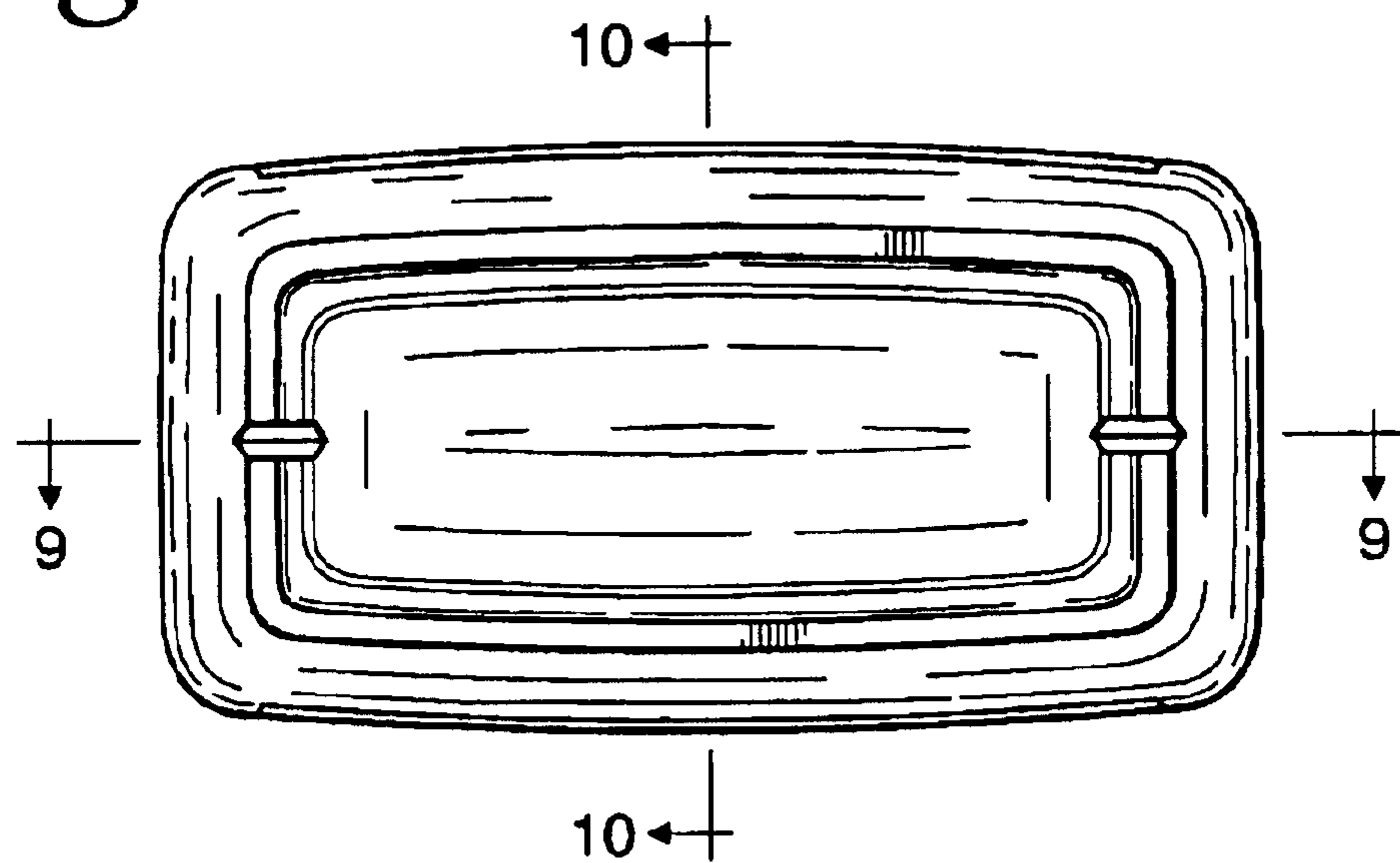

Fig. 7

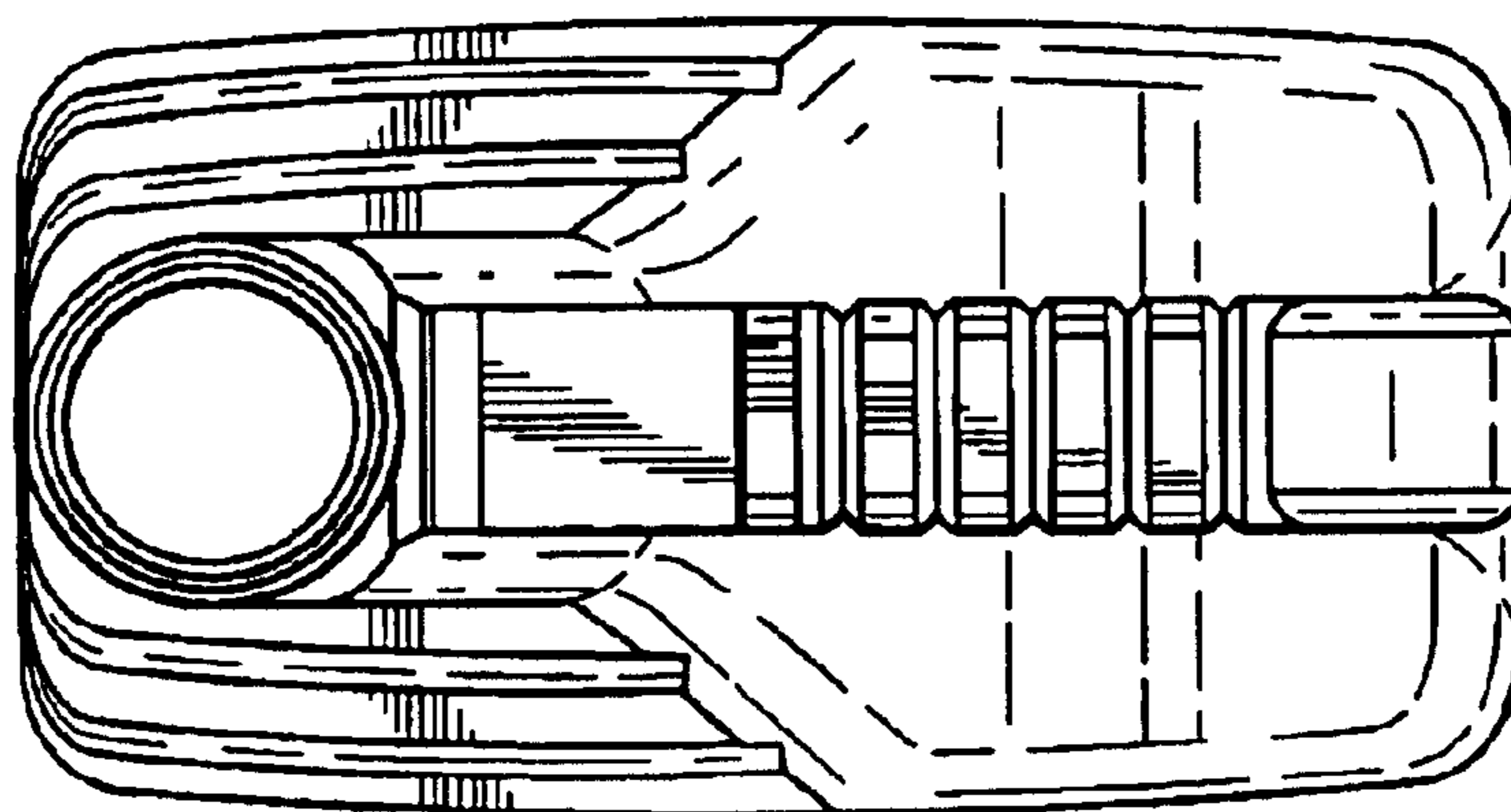

Fig. 8

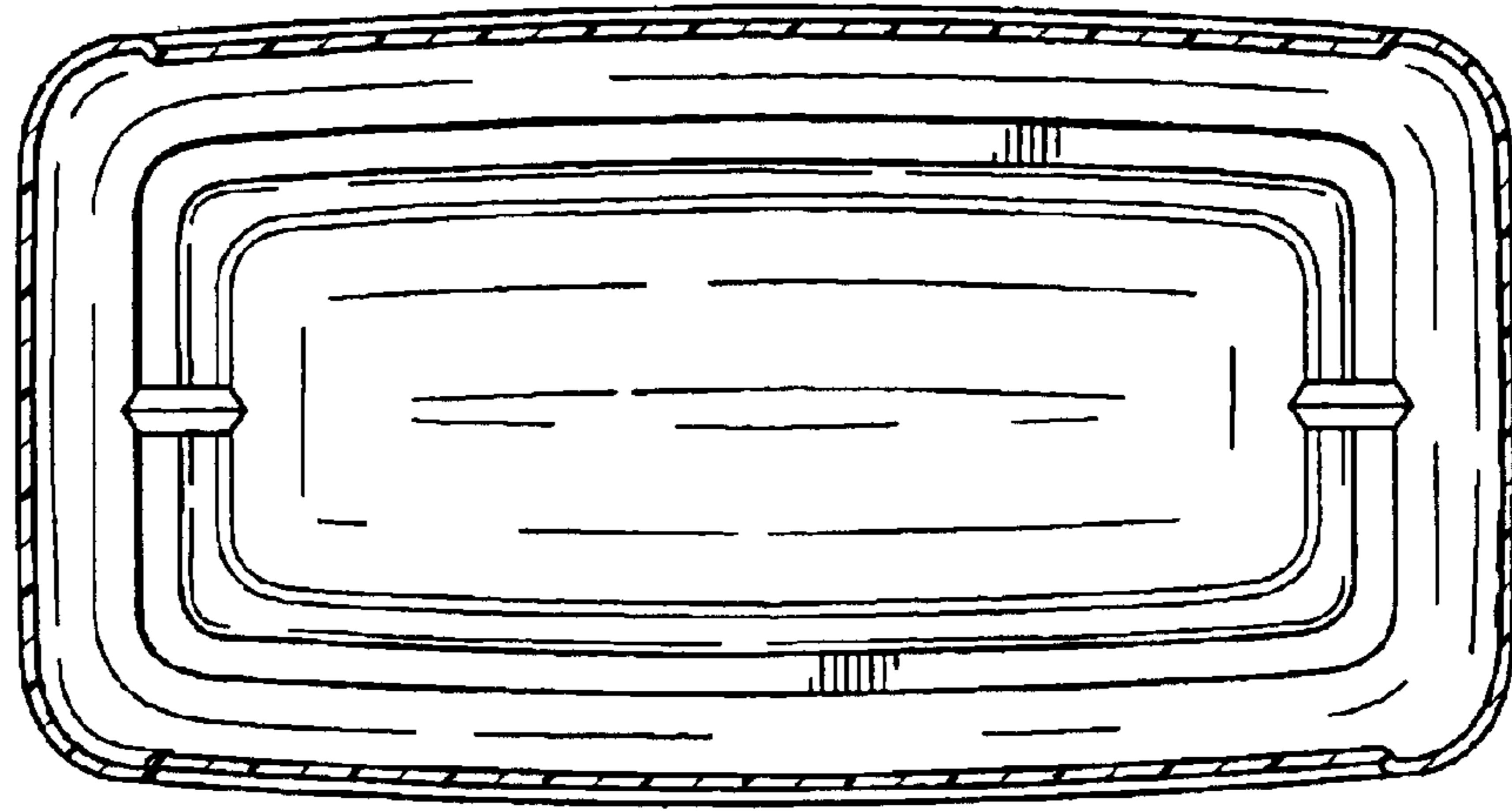

Fig. 9

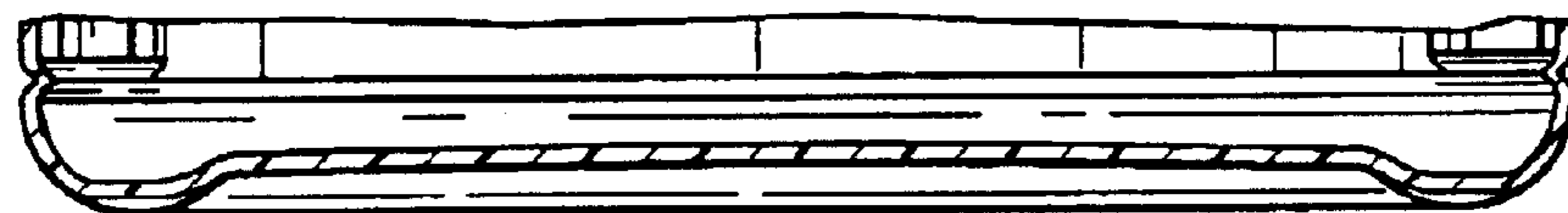

Fig. 10

