

US00D501360S

(12) **United States Design Patent**  
**Levinger**

(10) **Patent No.: US D501,360 S**

(45) **Date of Patent: \*\* Feb. 1, 2005**

(54) **LIGHTER AND STAND**

(75) **Inventor: Frederick Levinger, Providence, RI (US)**

(73) **Assignee: Colibri Corporation, RI (US)**

(\*\*) **Term: 14 Years**

(21) **Appl. No.: 29/200,955**

(22) **Filed: Mar. 8, 2004**

(51) **LOC (7) Cl. .... 07-99**

(52) **U.S. Cl. .... D7/416**

(58) **Field of Search** ..... D7/416, 417; D27/130, D27/160, 142, 139; 126/401, 25 B, 229, 521, 409, 403, 406; 431/255, 328, 344, 153, 345, 297; 417/411; D26/9, 10, 20, 22, 96; 298/146; 211/60.1, 71.01; 329/392

(56) **References Cited**

**U.S. PATENT DOCUMENTS**

D149,599 S	*	5/1948	Wilson	.....	D26/20
D204,898 S	*	5/1966	Gross	.....	D26/96
D212,898 S	*	12/1968	Stephens, Jr.	.....	D27/160
4,028,046 A	*	6/1977	Kilvert	.....	431/297
4,502,465 A	*	3/1985	Yoshinaga et al.	.....	126/409
D293,603 S	*	1/1988	Matsumaru	.....	D7/416
4,880,377 A	*	11/1989	Ficho	.....	431/126
5,490,496 A	*	2/1996	Lin	.....	126/414
D410,819 S	*	6/1999	Hsu	.....	D7/416

D458,512 S	*	6/2002	Dijkstra	.....	D7/416
D461,366 S	*	8/2002	Dijkstra	.....	D7/416
6,601,977 B2	*	8/2003	Gesue	.....	362/392
D484,741 S	*	1/2004	Tardiff et al.	.....	D7/416
D484,742 S	*	1/2004	Kim	.....	D7/416
D489,224 S	*	5/2004	Kwok	.....	D7/416
D495,204 S	*	8/2004	Fontaine	.....	D7/416

\* cited by examiner

*Primary Examiner*—M N Pandozzi

(74) *Attorney, Agent, or Firm*—Salter & Michaelson

(57) **CLAIM**

The ornamental design for a lighter and stand, as shown and described.

**DESCRIPTION**

FIG. 1 is a perspective view of the lighter and stand showing my new design;

FIG. 2 is a front elevational view thereof, the rear elevational view being a mirror image thereof;

FIG. 3 is a left side elevational view thereof;

FIG. 4 is a right side elevational view thereof;

FIG. 5 is a top plan view thereof;

FIG. 6 is a bottom plan view thereof; and,

FIG. 7 is an exploded perspective view thereof showing the lighter and stand.

The portions shown in broken lines are included for illustrative purpose only and form no part of the claimed design.

**1 Claim, 6 Drawing Sheets**

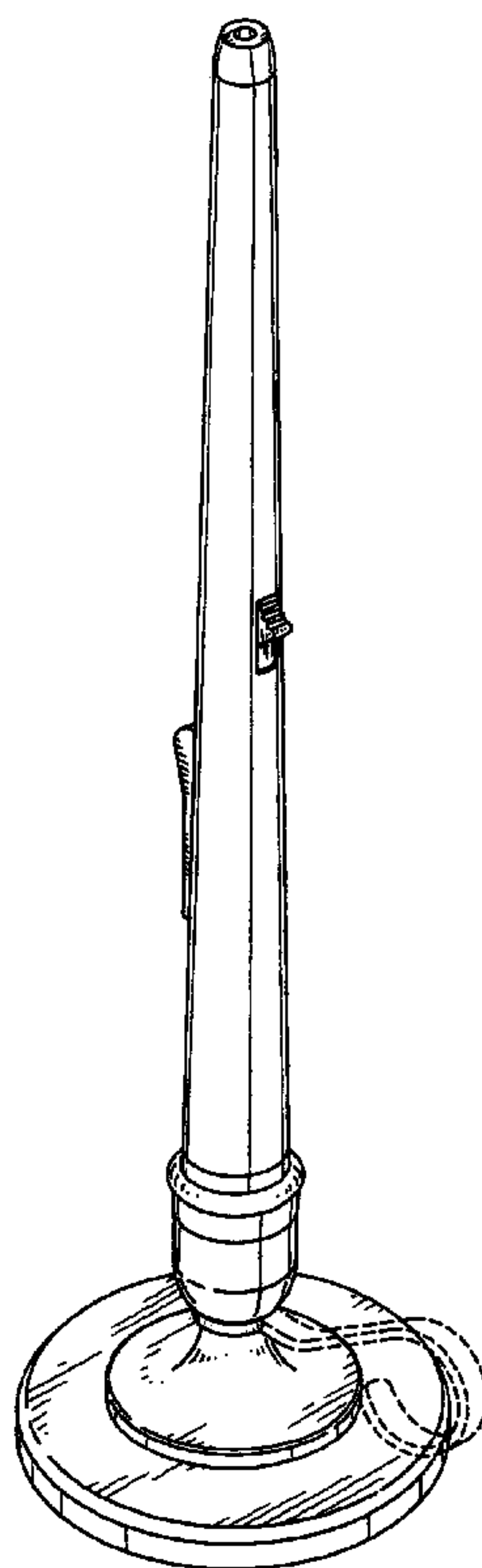
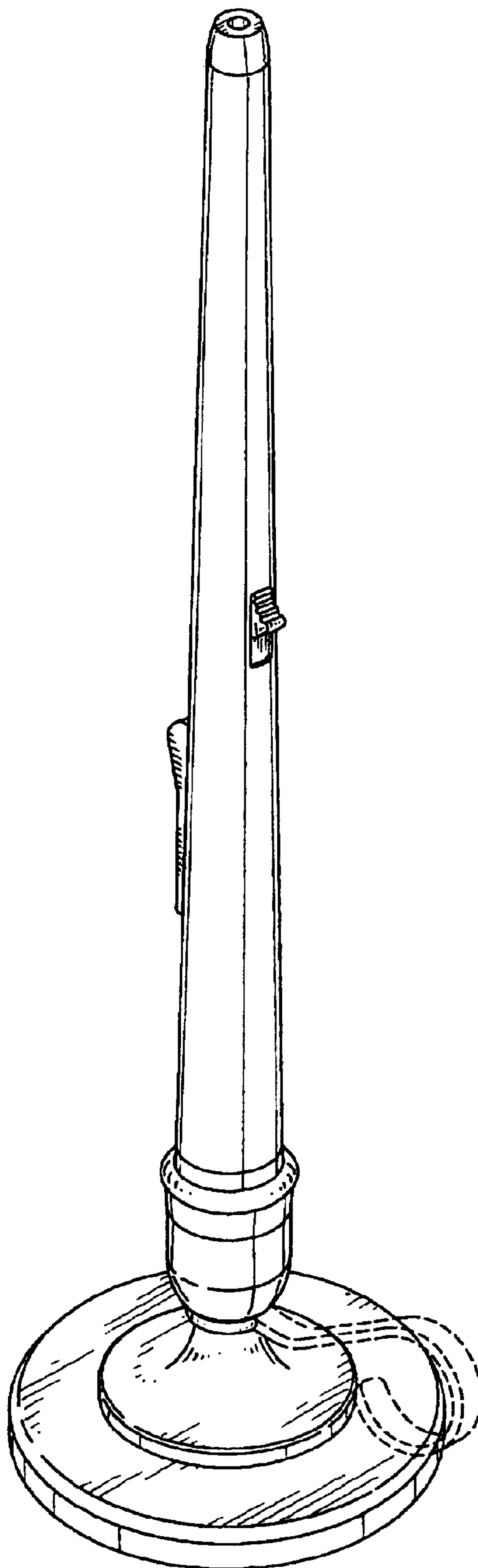

FIG. 1



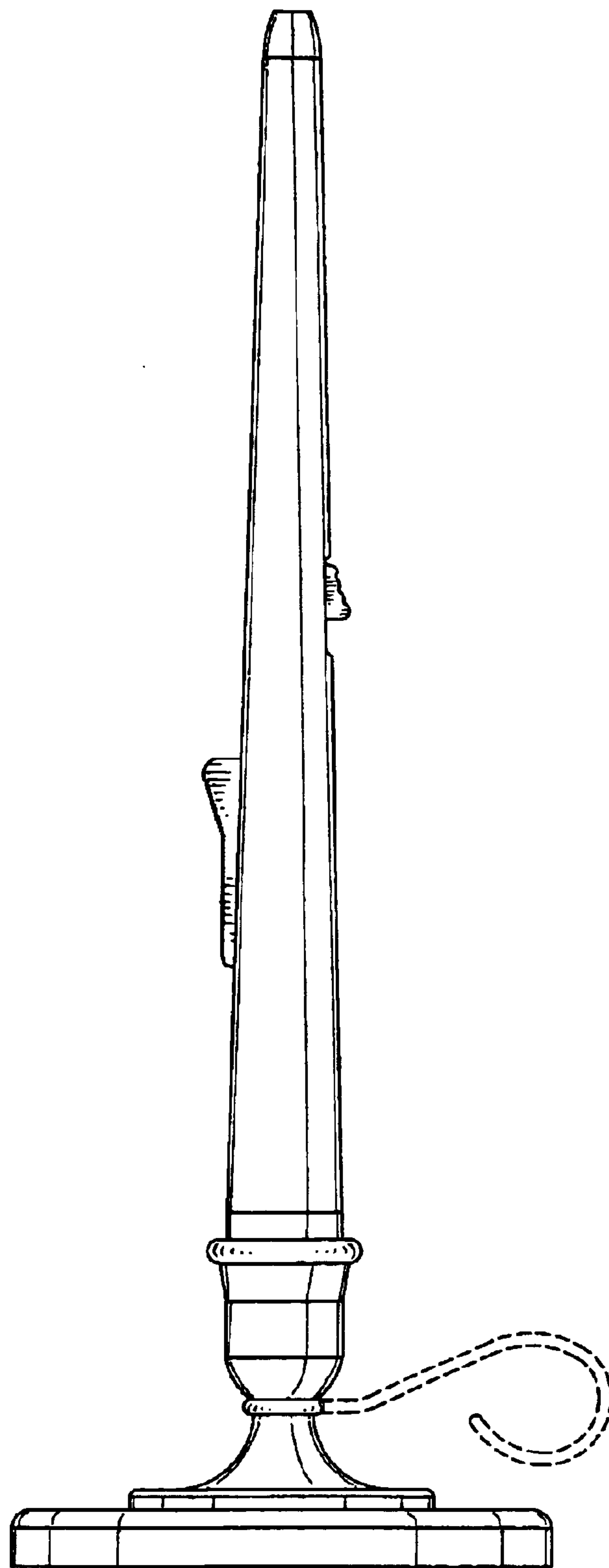

FIG. 2

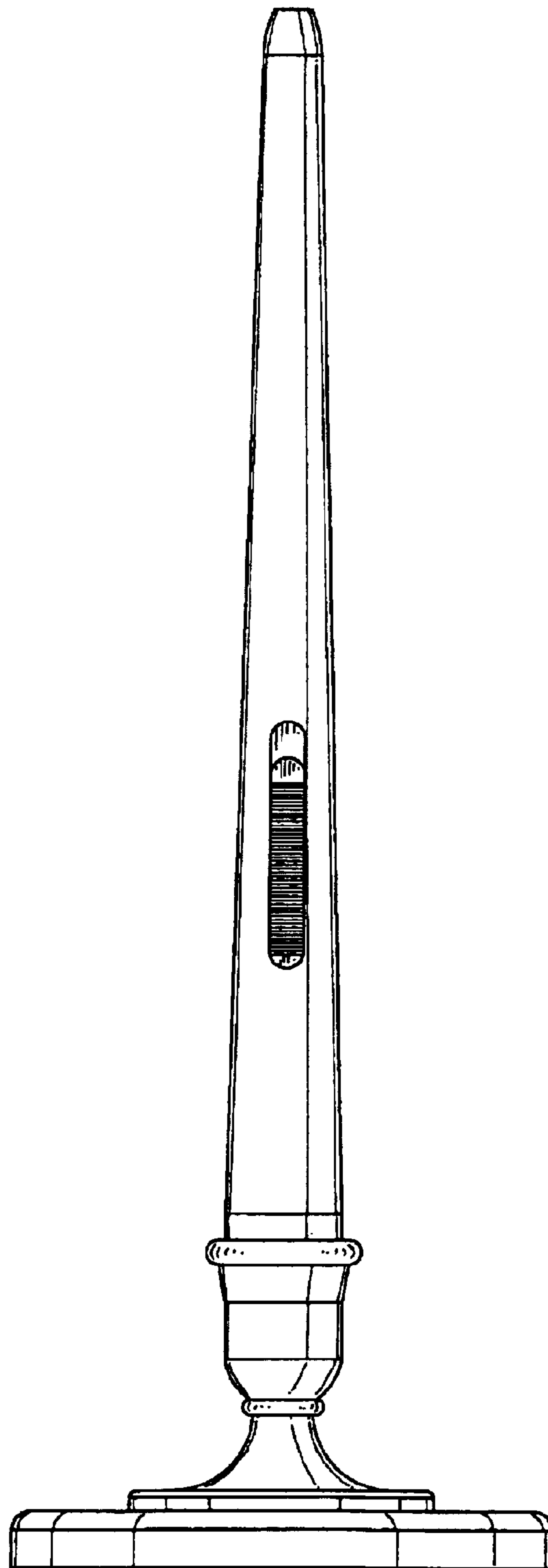

FIG. 3

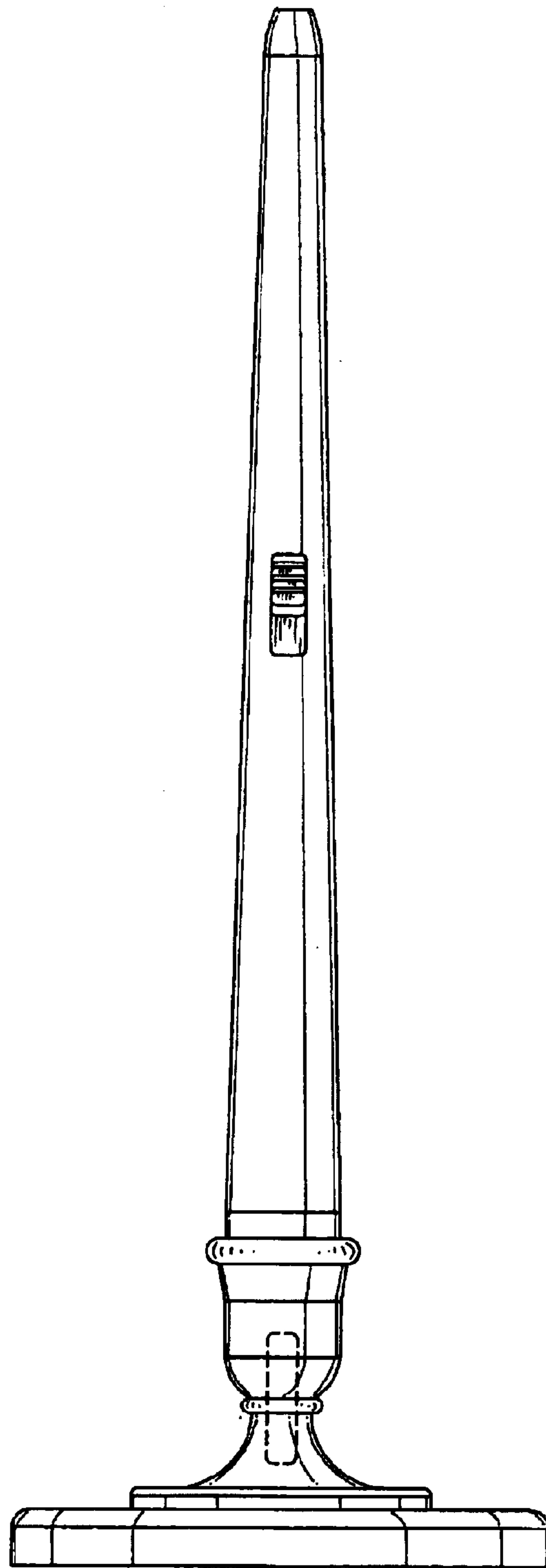

FIG. 4

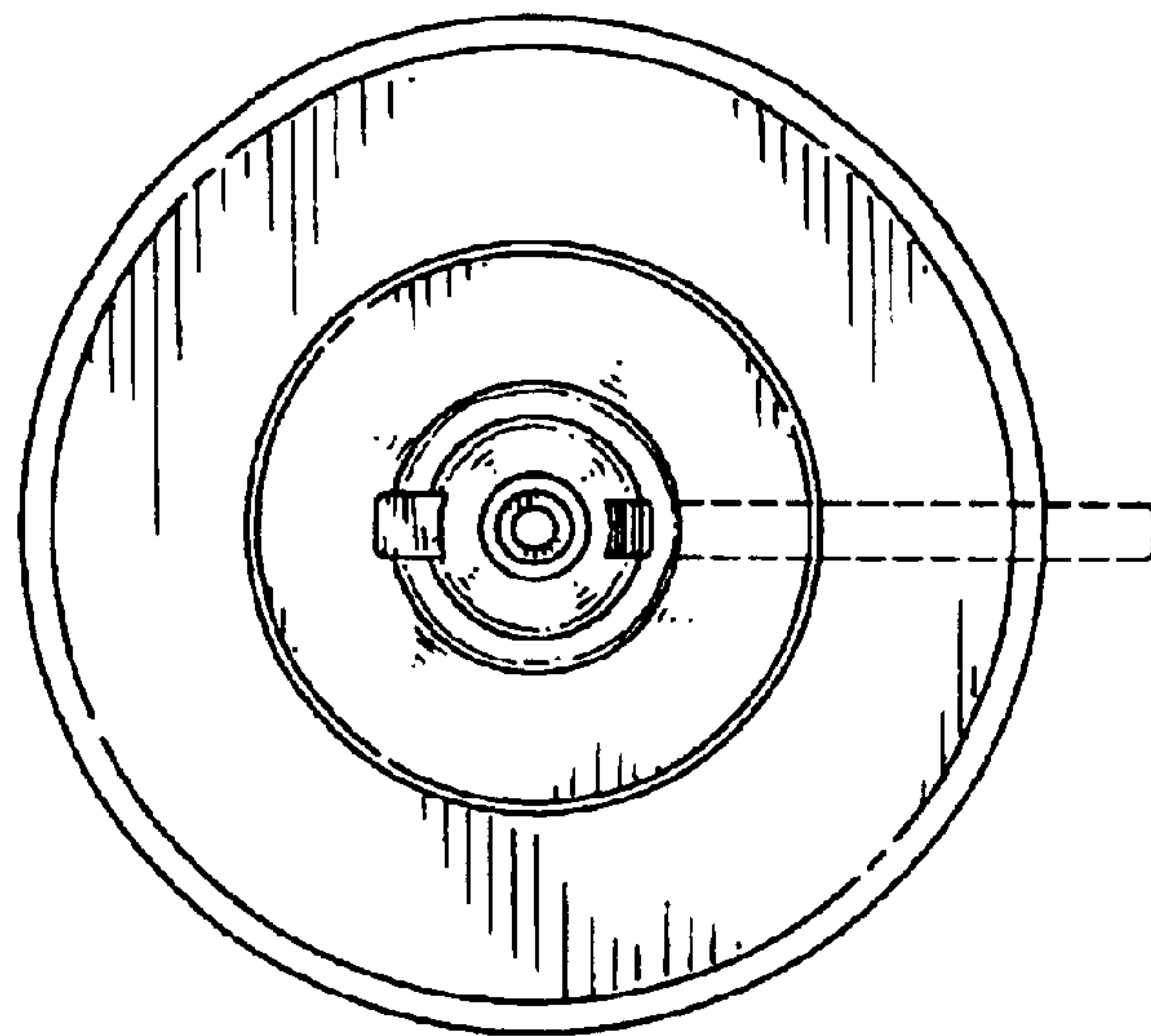

FIG. 5

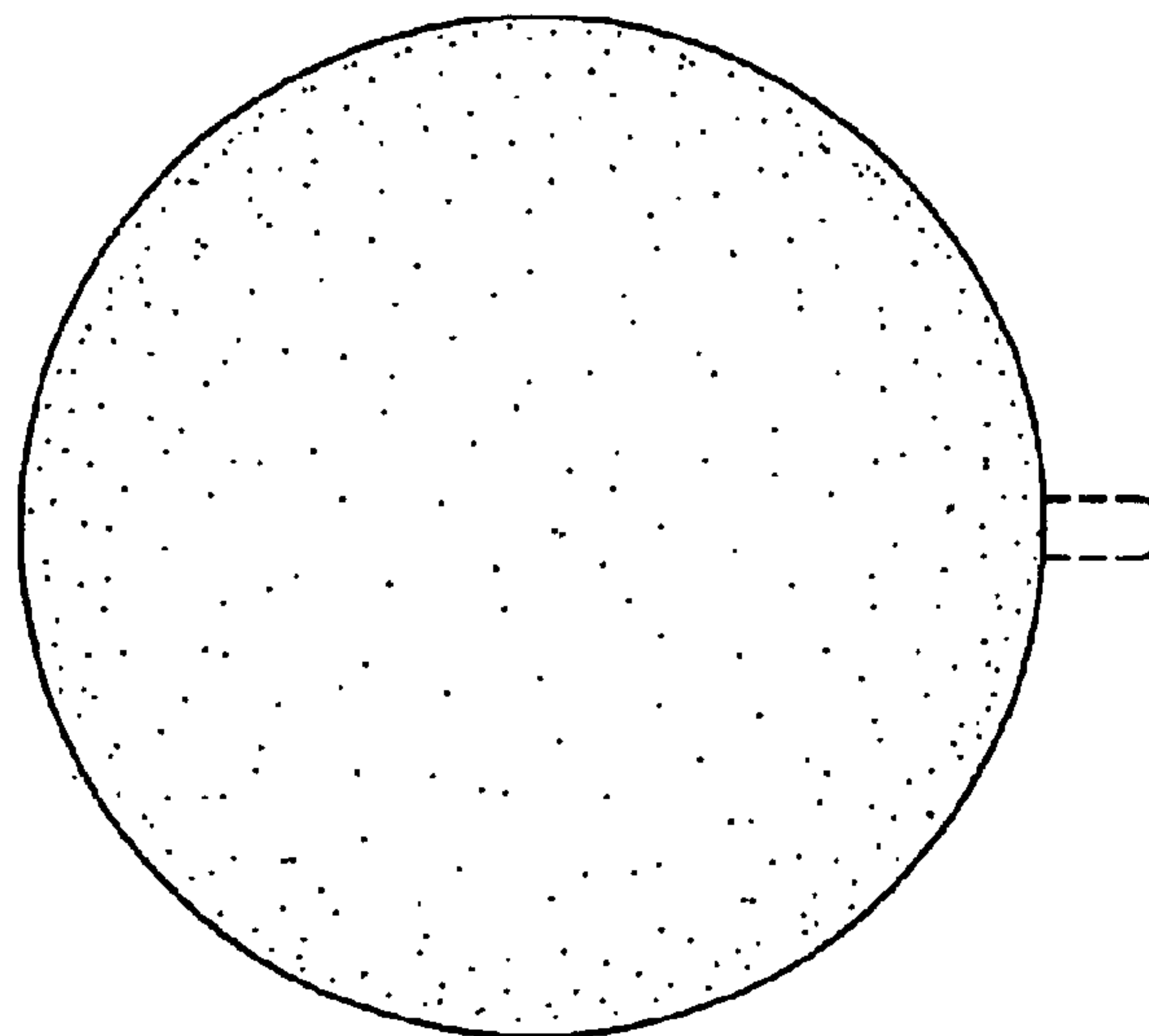

FIG. 6

FIG. 7

