

US00D501338S

(12) **United States Design Patent**  
**Deasy et al.**

(10) **Patent No.: US D501,338 S**  
(45) **Date of Patent: \*\* Feb. 1, 2005**

(54) **SHELF UNIT**

(75) Inventors: **Richard Deasy**, Pittsburgh, PA (US);  
**Allan Ross**, Masury, OH (US)

(73) Assignee: **ALCO Industries, Inc.**, Valley Forge,  
PA (US)

(\*\*) Term: **14 Years**

(21) Appl. No.: **29/198,981**

(22) Filed: **Feb. 5, 2004**

(51) **LOC (7) Cl.** ..... **06-04**

(52) **U.S. Cl.** ..... **D6/479**

(58) **Field of Search** ..... D6/407, 474, 477-479;  
108/59, 64, 91-93, 107, 149, 151, 182,  
144.11, 147.11, 147.13; 211/13.1, 42, 43,  
49.1, 85.26, 134, 187-190, 153, 207

(56) **References Cited**

**U.S. PATENT DOCUMENTS**

D233,294 S	*	10/1974	Goulder	.....	D6/474
4,099,472 A	*	7/1978	Kellogg	.....	108/185
D303,596 S		9/1989	Goetz		

(List continued on next page.)

*Primary Examiner*—Cathron Brooks

(74) *Attorney, Agent, or Firm*—Reed Smith LLP

(57) **CLAIM**

The ornamental design for a shelf unit, as shown and described.

**DESCRIPTION**

FIG. 1 is a perspective view of a shelf unit in accordance with the invention;

FIG. 2 is a front elevational view of the shelf unit thereof;

FIG. 3 is an end elevational view of the shelf unit thereof;

FIG. 4 is a rear elevational view of the shelf unit thereof;

FIG. 5 is a top plan view of the shelf unit thereof;

FIG. 6 is a bottom plan view of the shelf unit thereof;

FIG. 7 is a perspective view of a second embodiment of the shelf unit shown in FIG. 1;

FIG. 8 is a front elevational view of the shelf unit thereof;

FIG. 9 is an end elevational view of the shelf unit thereof;

FIG. 10 is a rear elevational view of the shelf unit thereof;

FIG. 11 is a top plan view of the shelf unit thereof;

FIG. 12 is a bottom plan view of the shelf unit thereof;

FIG. 13 is a perspective view of a third embodiment of the shelf unit shown in FIG. 1;

FIG. 14 is a front elevational view of the shelf unit thereof;

FIG. 15 is an end elevational view of the shelf unit thereof;

FIG. 16 is a rear elevational view of the shelf unit thereof;

FIG. 17 is a top plan view of the shelf unit thereof;

FIG. 18 is a bottom plan view of the shelf unit thereof;

FIG. 19 is a perspective view of a fourth embodiment of the shelf unit shown in FIG. 1;

FIG. 20 is a front elevational view of the shelf unit thereof;

FIG. 21 is an end elevational view of the shelf unit thereof;

FIG. 22 is a rear elevational view of the shelf unit thereof;

FIG. 23 is a top plan view of the shelf unit thereof;

FIG. 24 is a bottom plan view of the shelf unit thereof;

FIG. 25 is a perspective view of a fifth embodiment of the shelf unit shown in FIG. 1;

FIG. 26 is a front elevational view of the shelf unit thereof;

FIG. 27 is an end elevational view of the shelf unit thereof;

FIG. 28 is a rear elevational view of the shelf unit thereof;

FIG. 29 is a top plan view of the shelf unit thereof;

FIG. 30 is a bottom plan view of the shelf unit thereof;

FIG. 31 is a perspective view of a sixth embodiment of the shelf unit shown in FIG. 1;

FIG. 32 is a front elevational view of the shelf unit thereof;

FIG. 33 is an end elevational view of the shelf unit thereof;

FIG. 34 is a rear elevational view of the shelf unit thereof;

FIG. 35 is a top plan view of the shelf unit thereof;

FIG. 36 is a bottom plan view of the shelf unit thereof;

FIG. 37 is a perspective view of a seventh embodiment of the shelf unit shown in FIG. 1;

FIG. 38 is a front elevational view of the shelf unit thereof;

FIG. 39 is an end elevational view of the shelf unit thereof;

FIG. 40 is a rear elevational view of the shelf unit thereof;

FIG. 41 is a top plan view of the shelf unit thereof; and,

FIG. 42 is a bottom plan view of the shelf unit thereof.

**1 Claim, 30 Drawing Sheets**

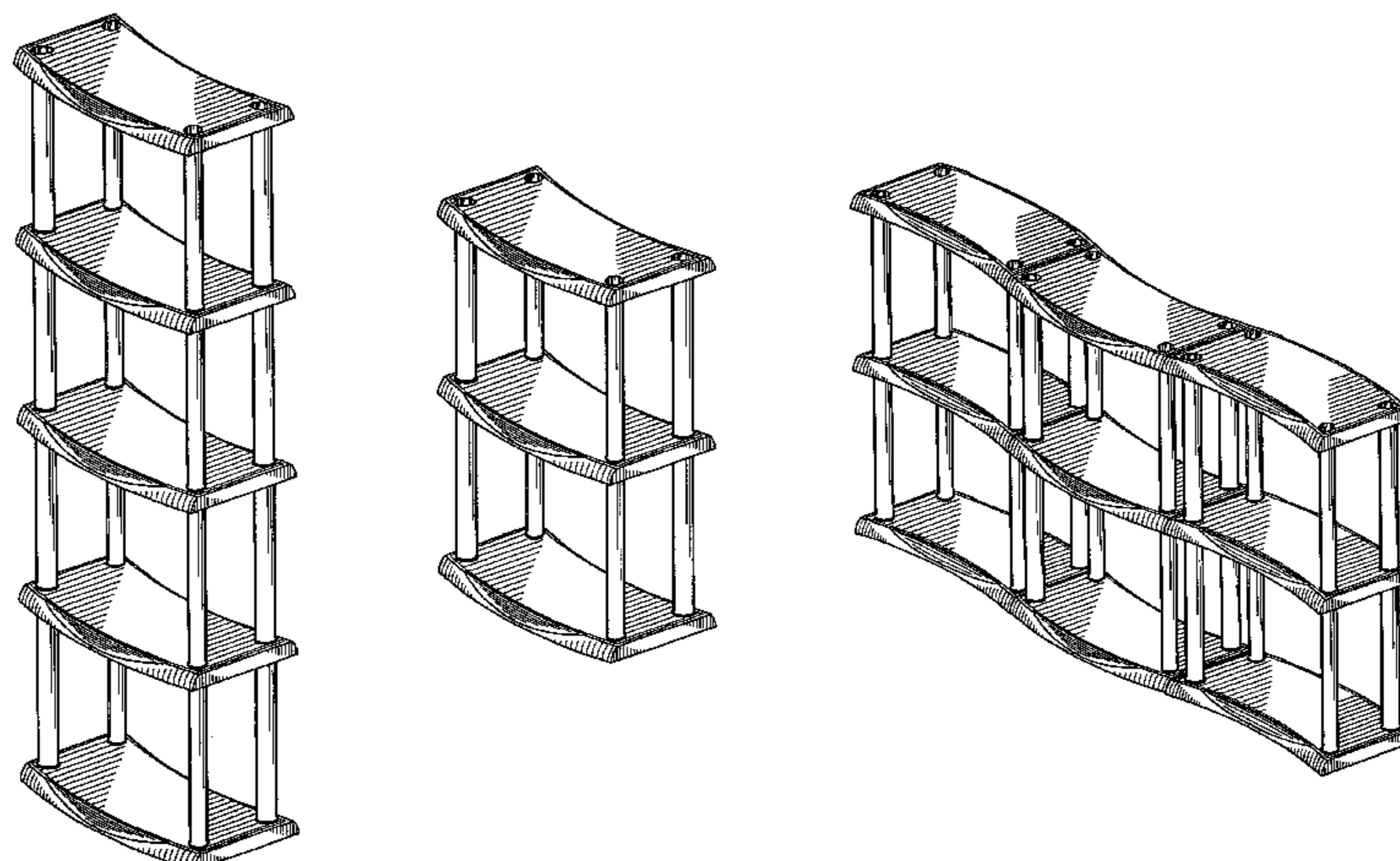

# US D501,338 S

Page 2

---

## U.S. PATENT DOCUMENTS

D304,398 S	11/1989	Goetz		D419,802 S	2/2000	Carville et al.	
D330,652 S	11/1992	Goetz		D423,840 S	5/2000	Carville et al.	
D337,673 S	7/1993	Goetz		D429,582 S *	8/2000	Grosfillex	..... D6/479
D383,014 S *	9/1997	Sagol	..... D6/479	6,290,074 B1 *	9/2001	Syvuk et al.	..... 211/74
D400,739 S *	11/1998	Sheng	..... D6/479	D459,640 S *	7/2002	Chung et al.	..... D7/708
D418,341 S	1/2000	Carville et al.		D477,160 S *	7/2003	Grosfillex	..... D6/479

\* cited by examiner

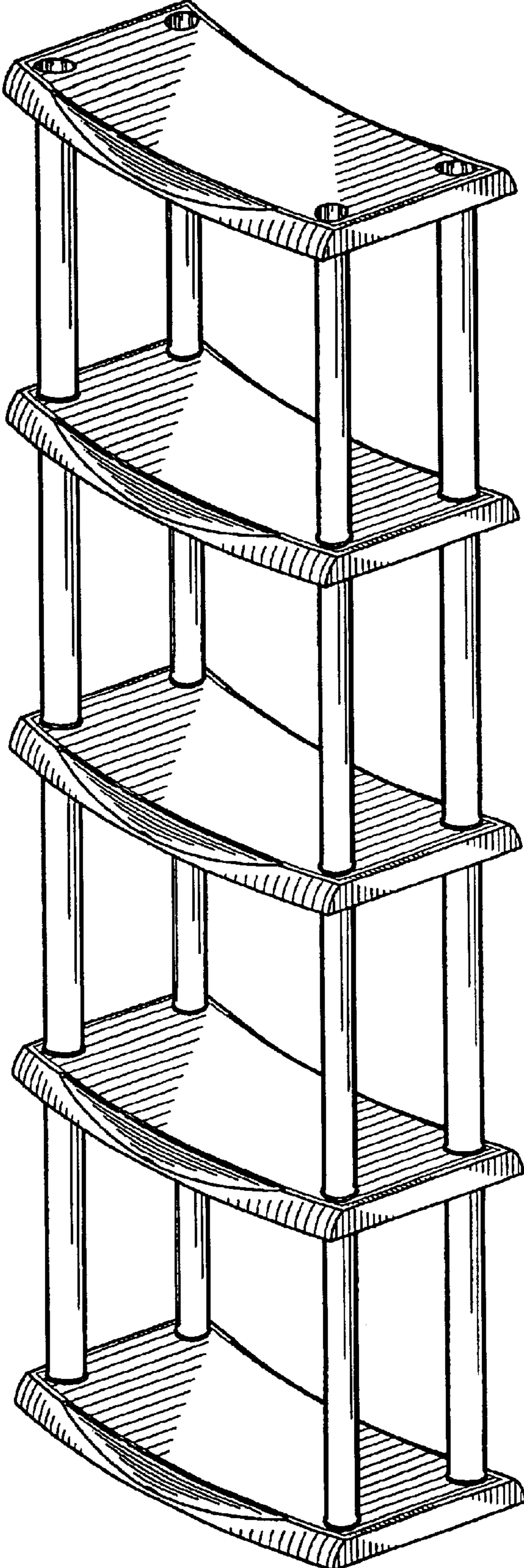

FIG. 1

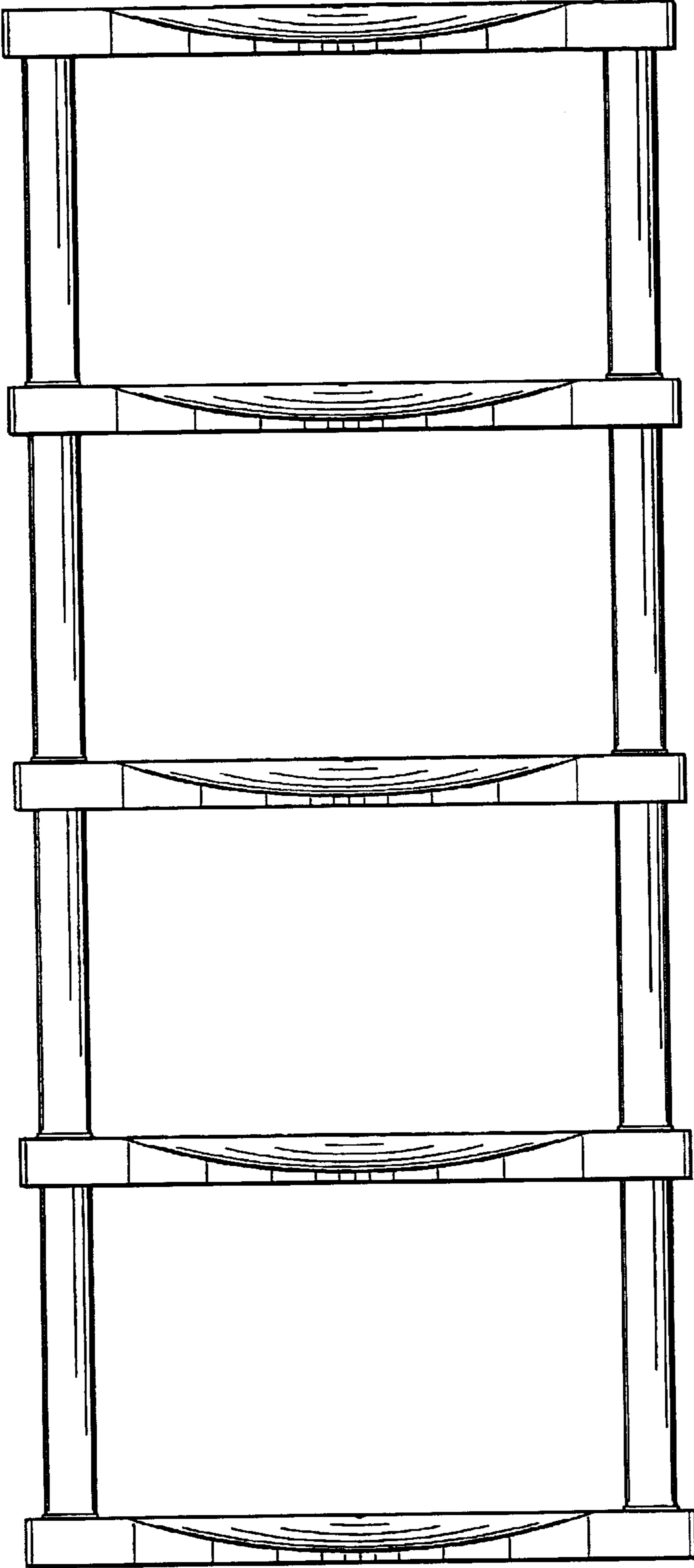

FIG. 2

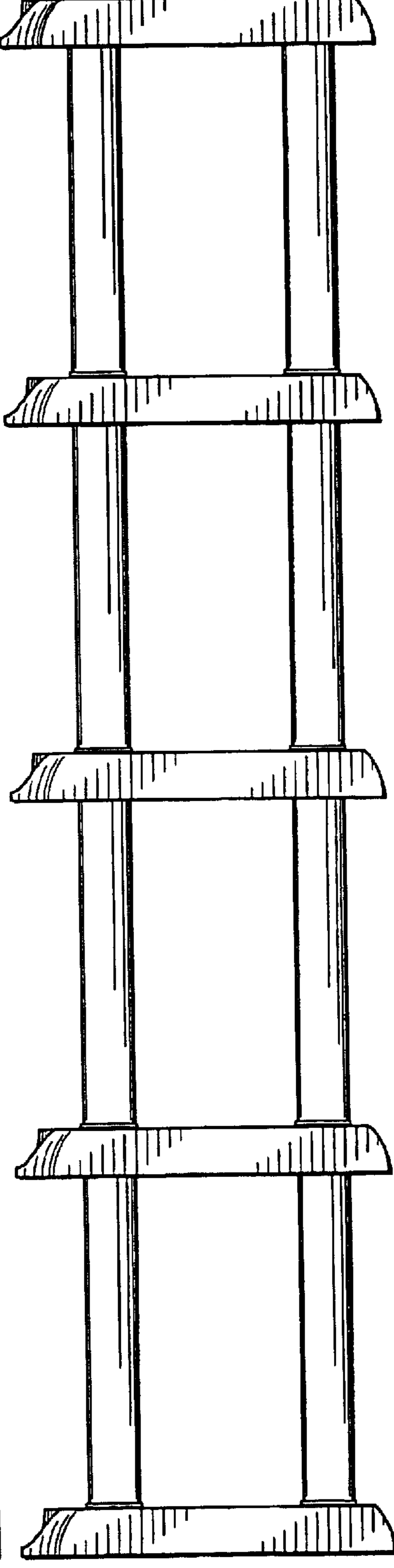

FIG. 3

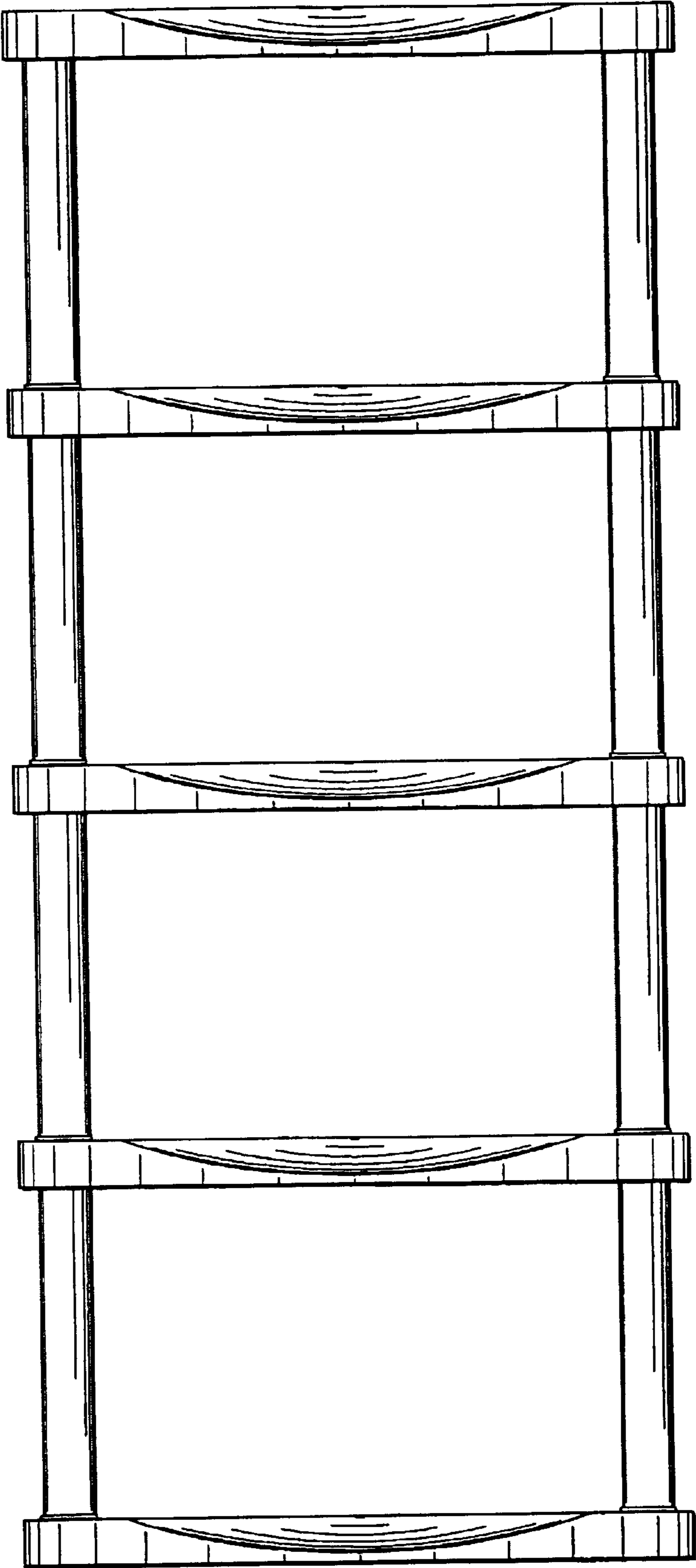

FIG. 4

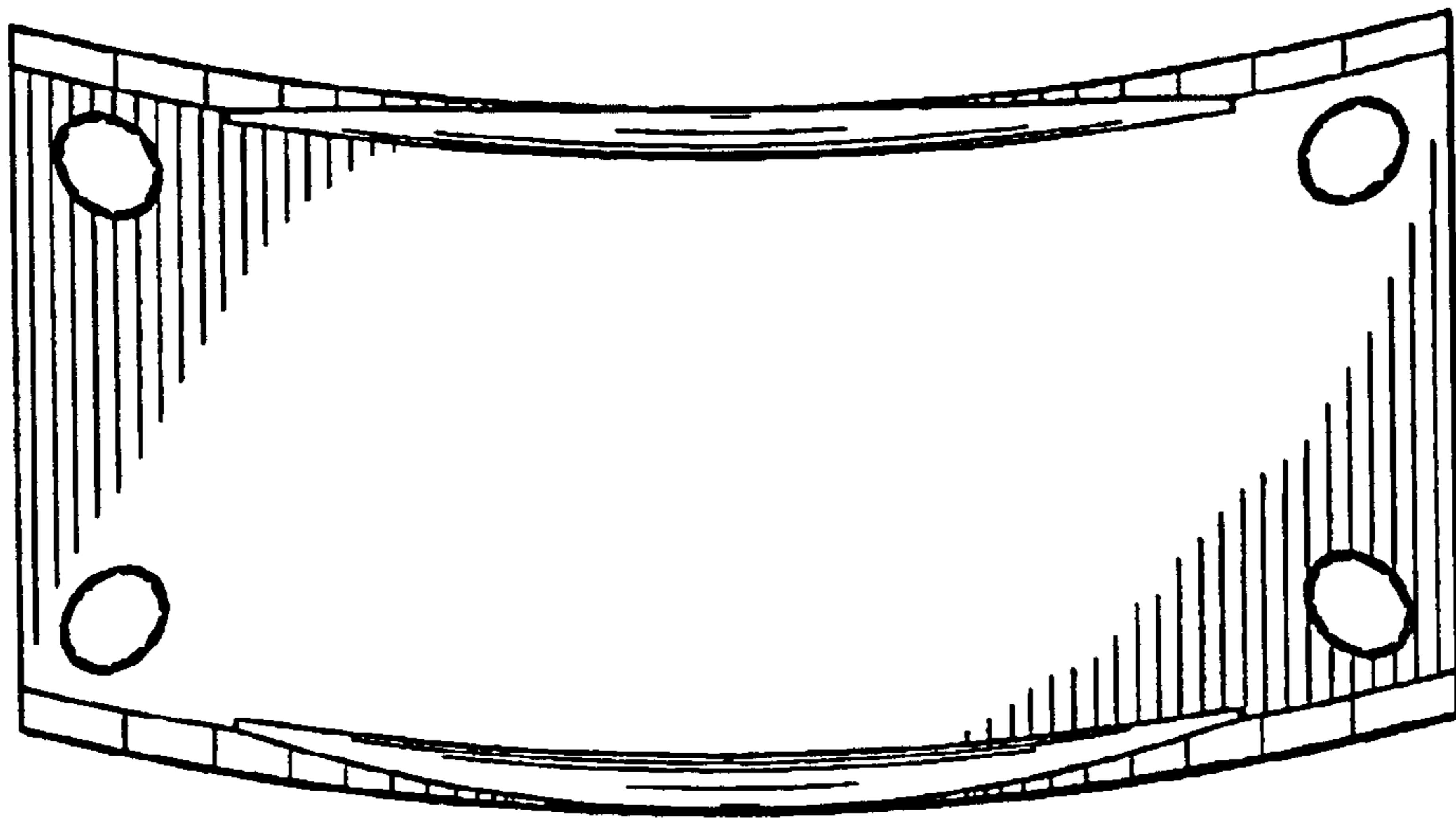

FIG. 5

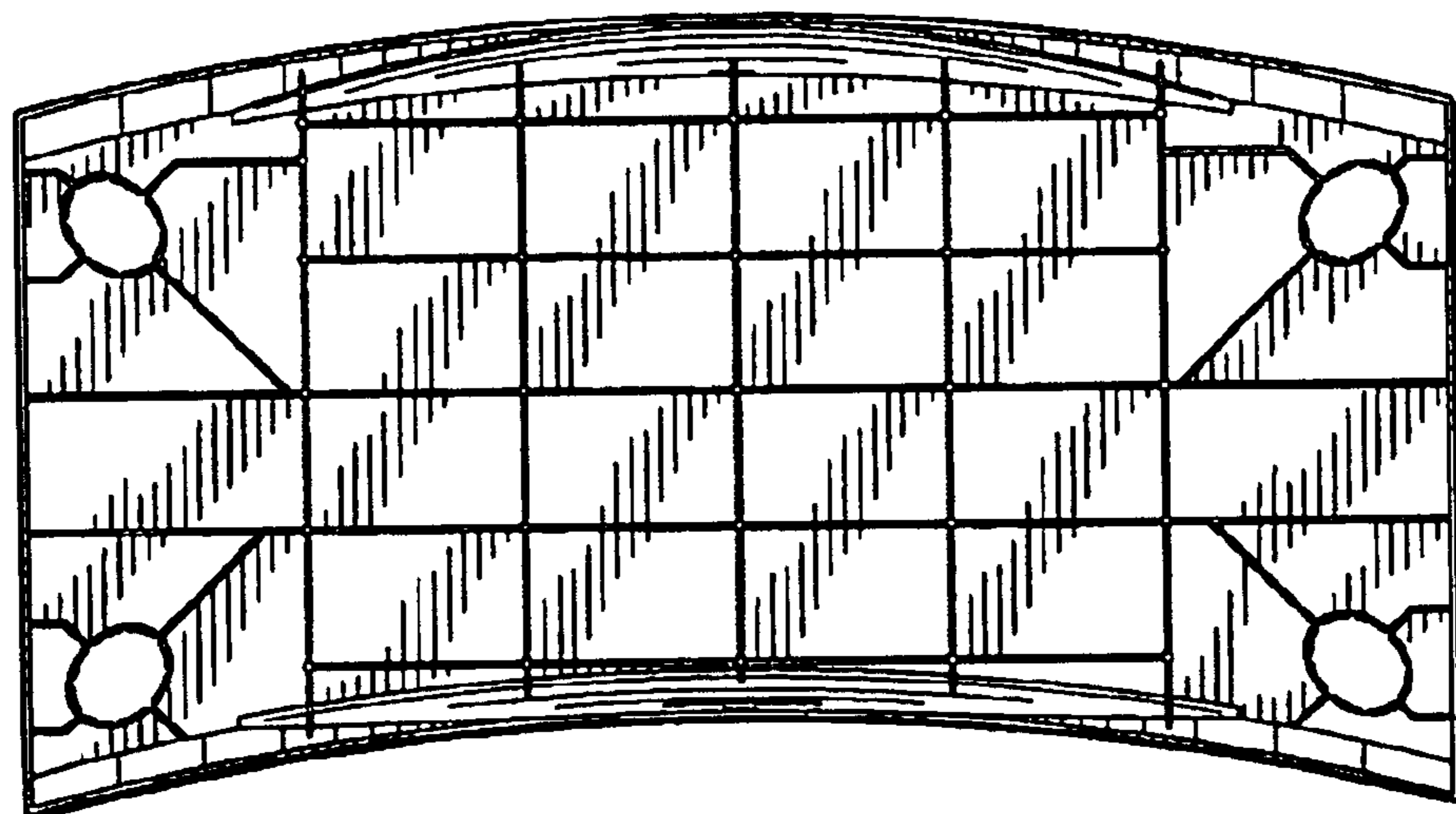

FIG. 6

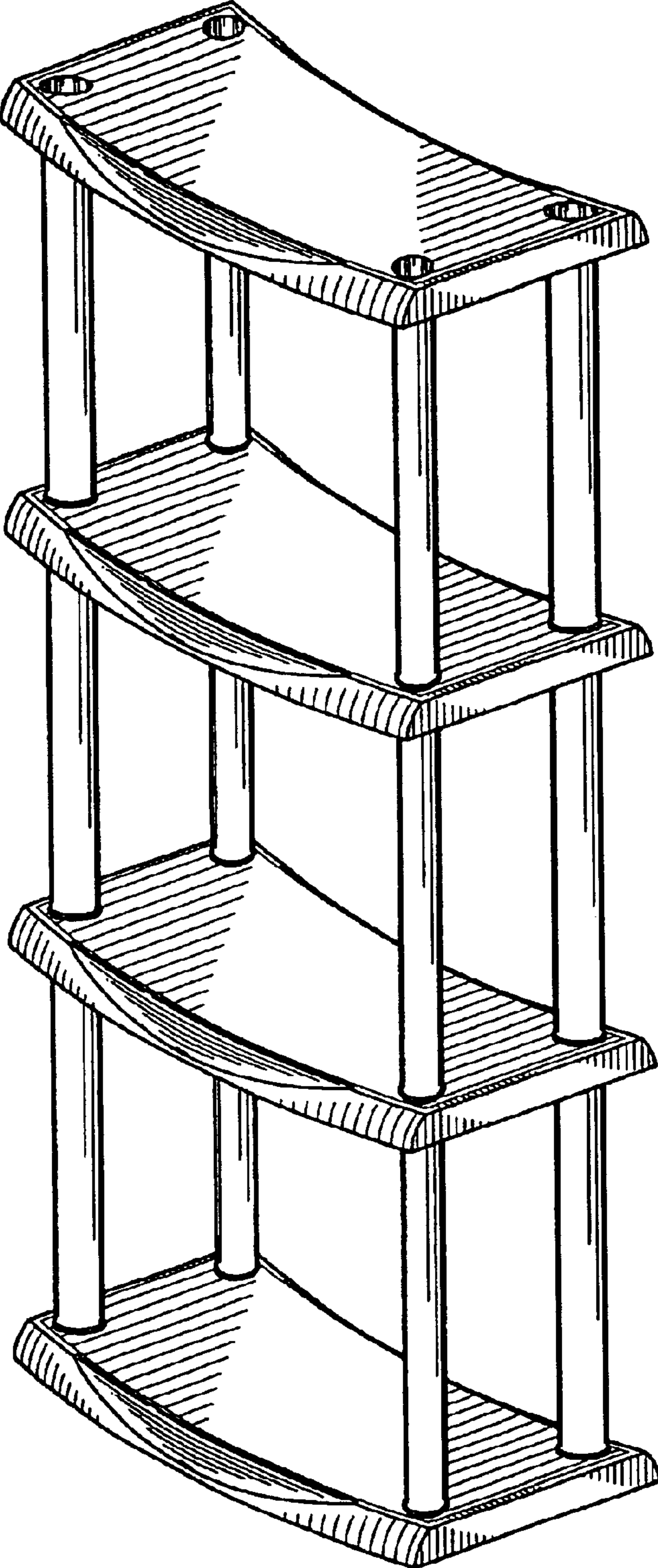

FIG. 7

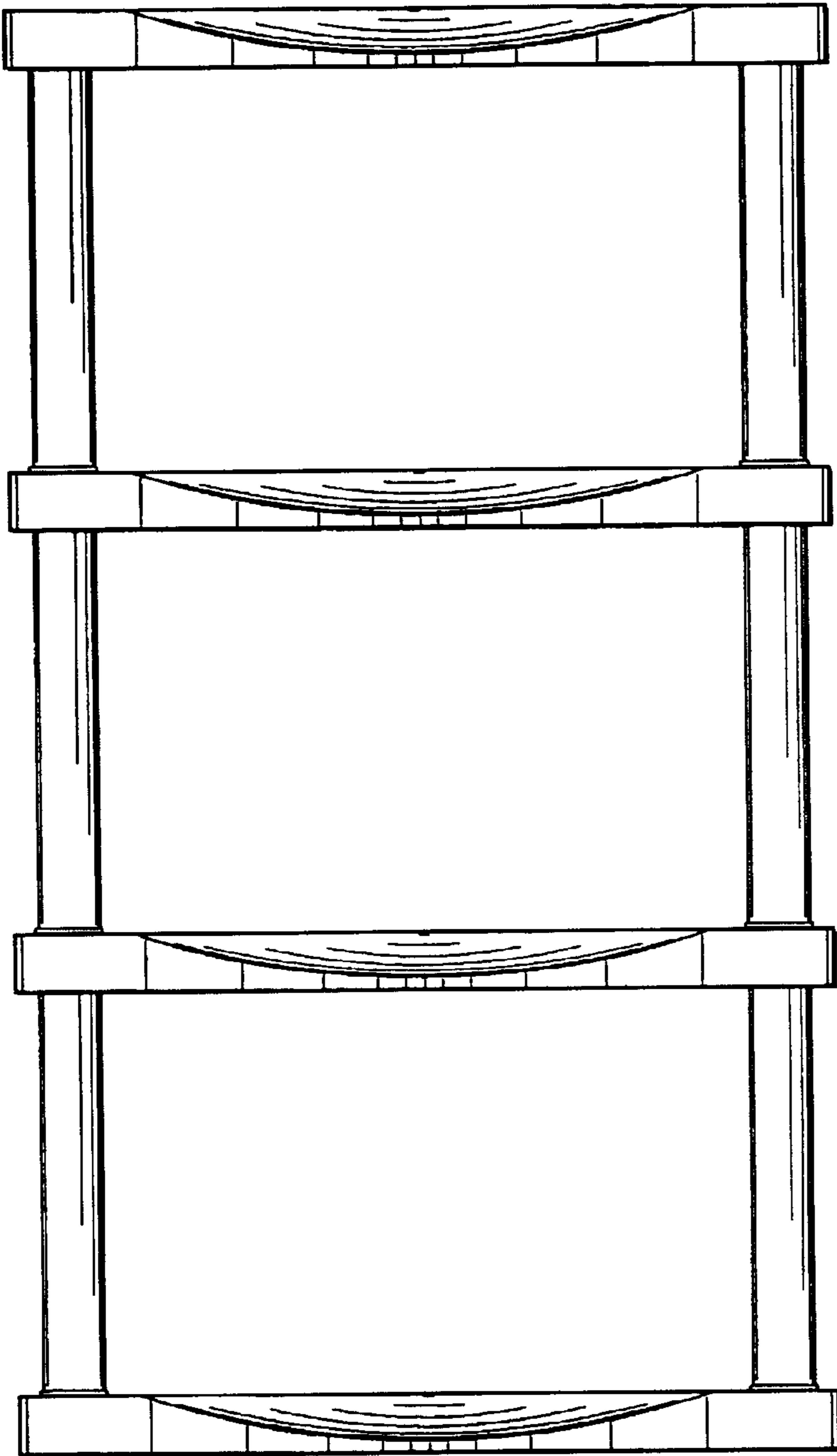

FIG. 8

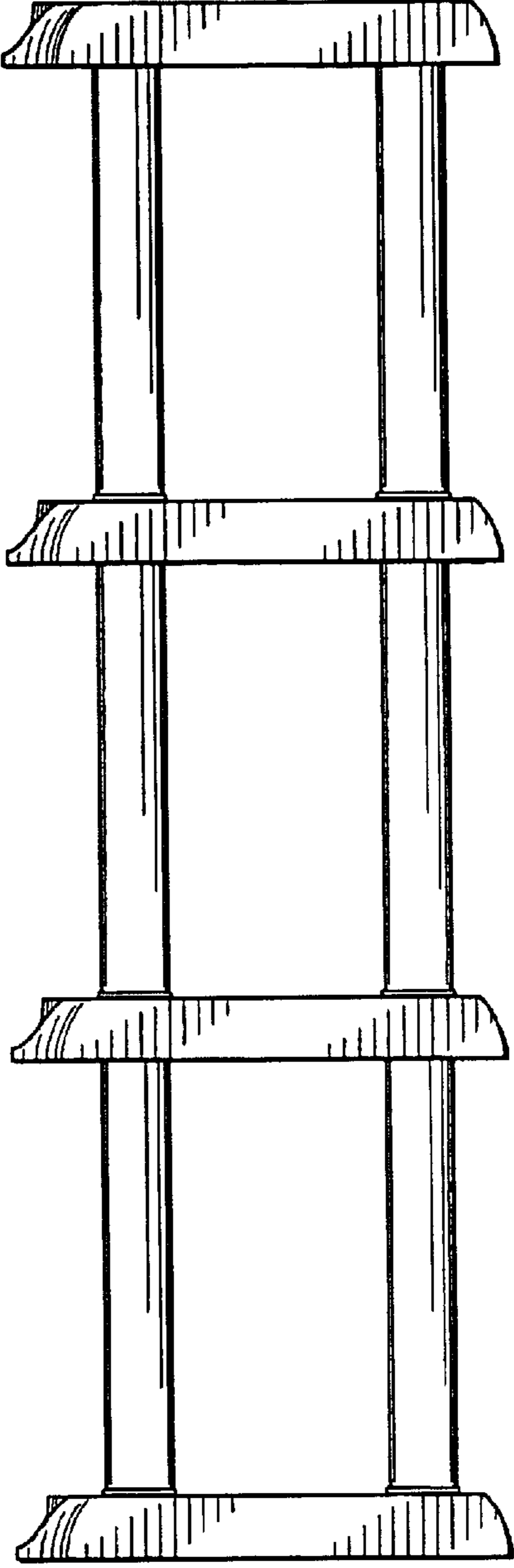

FIG. 9



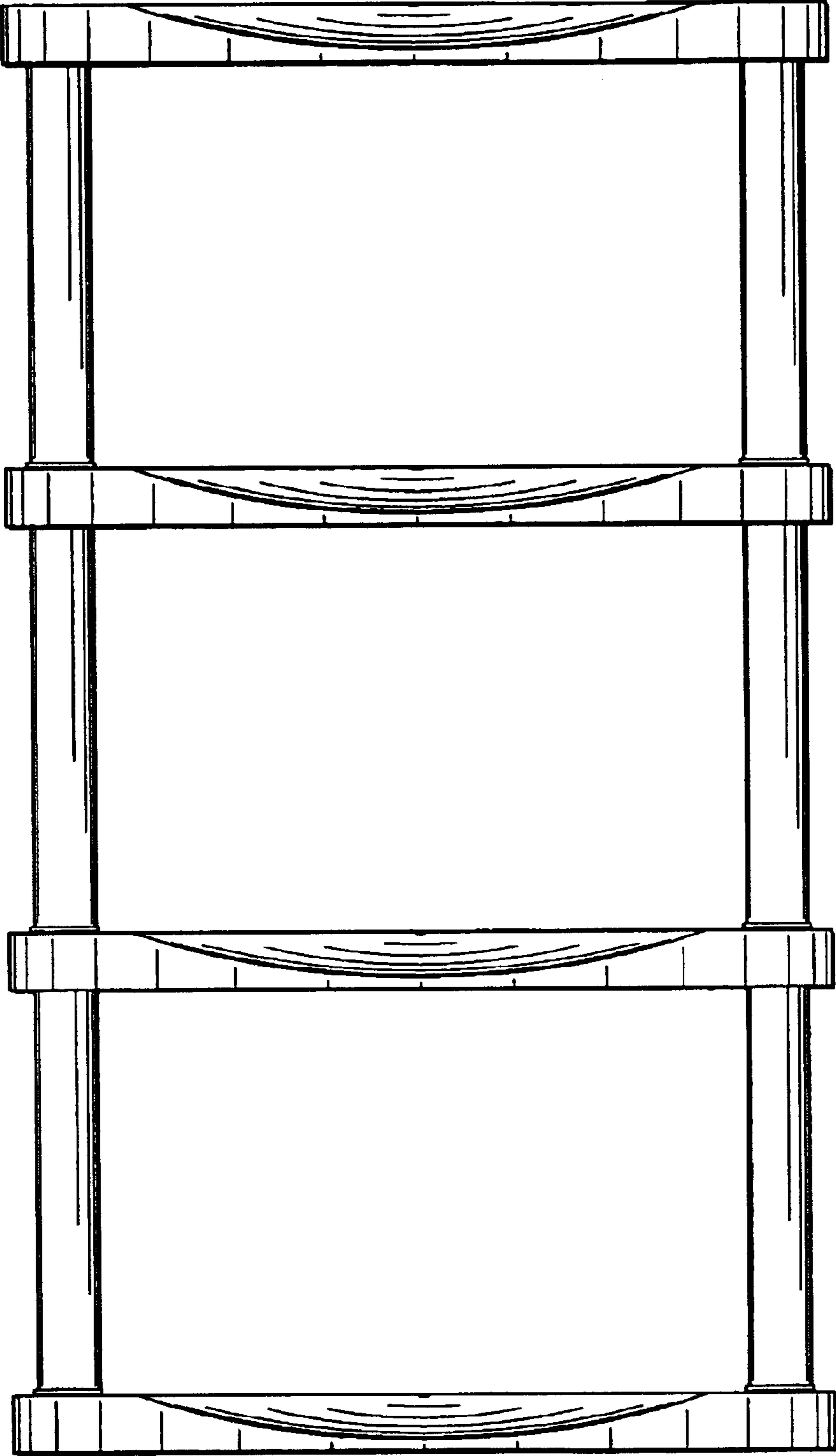

FIG. 10

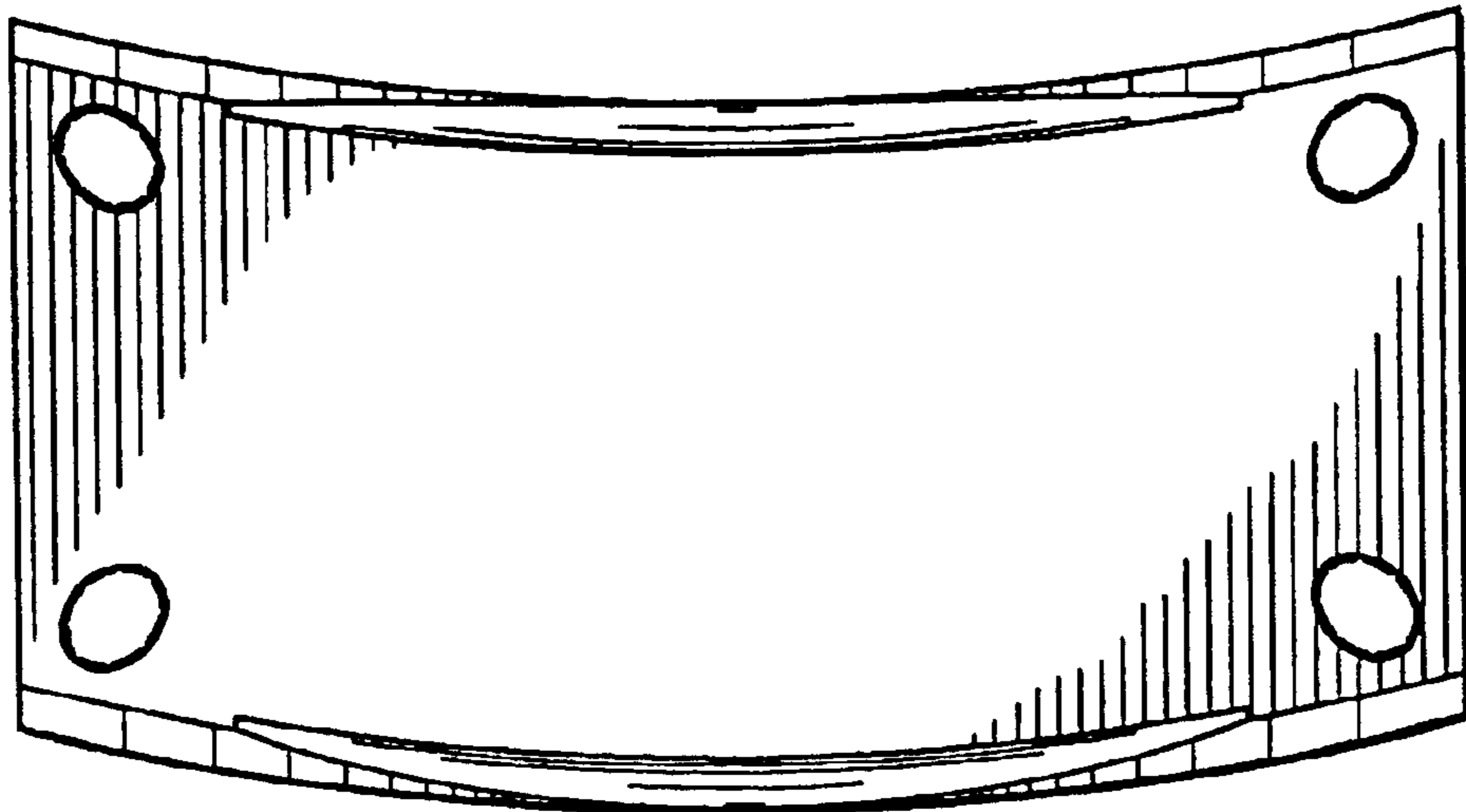

FIG. 11

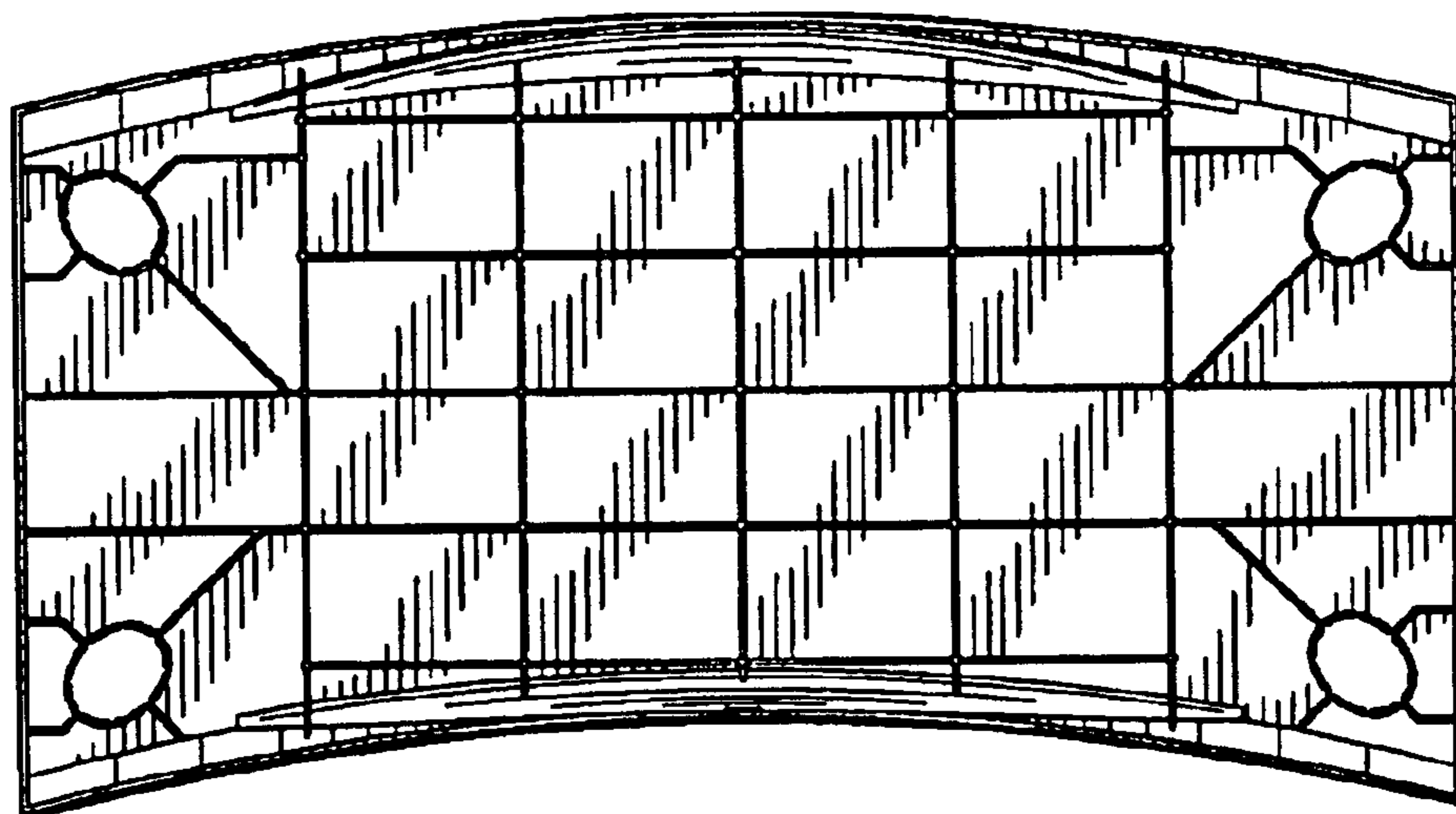

FIG. 12

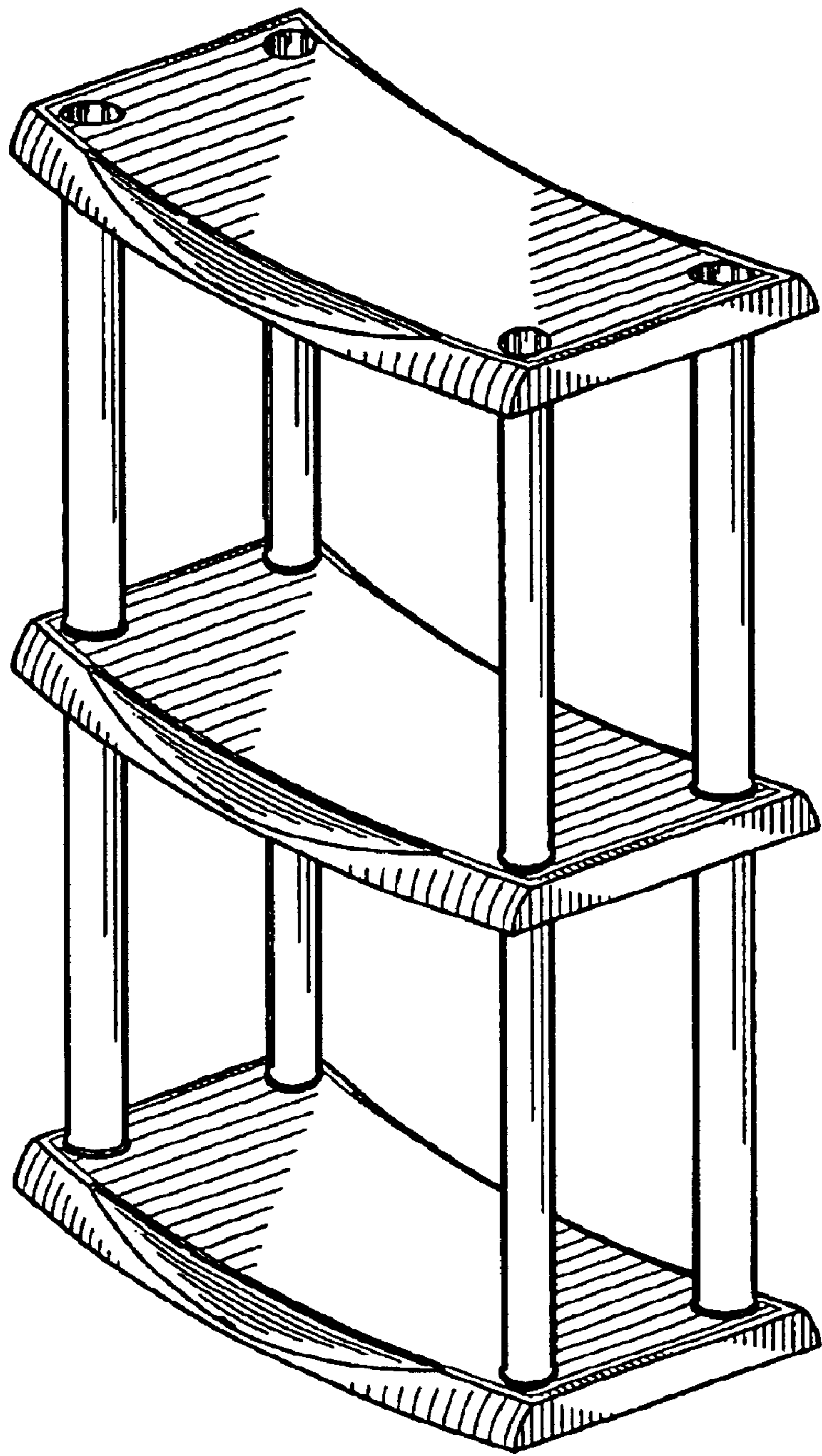

FIG. 13

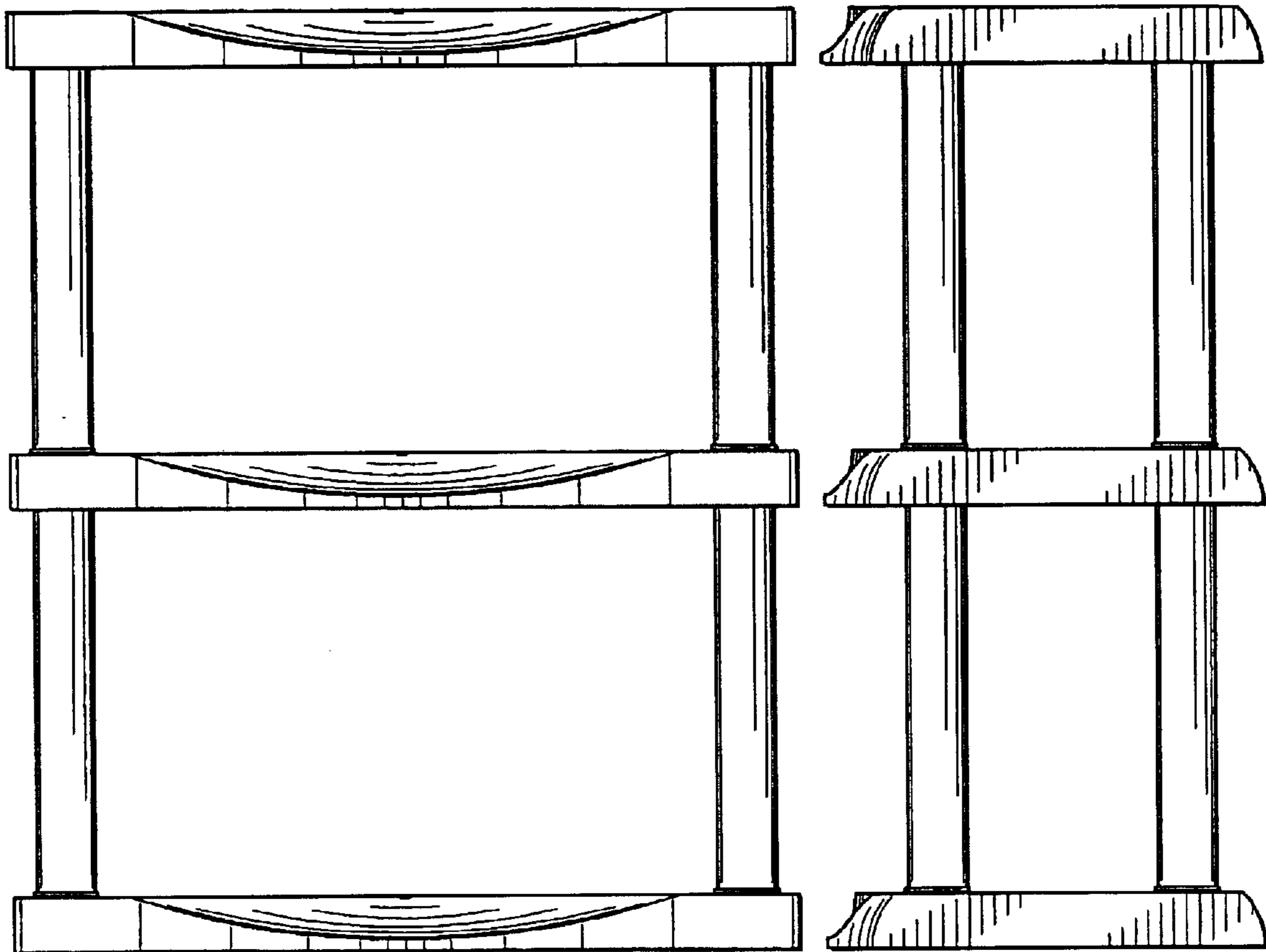

FIG. 14

FIG. 15

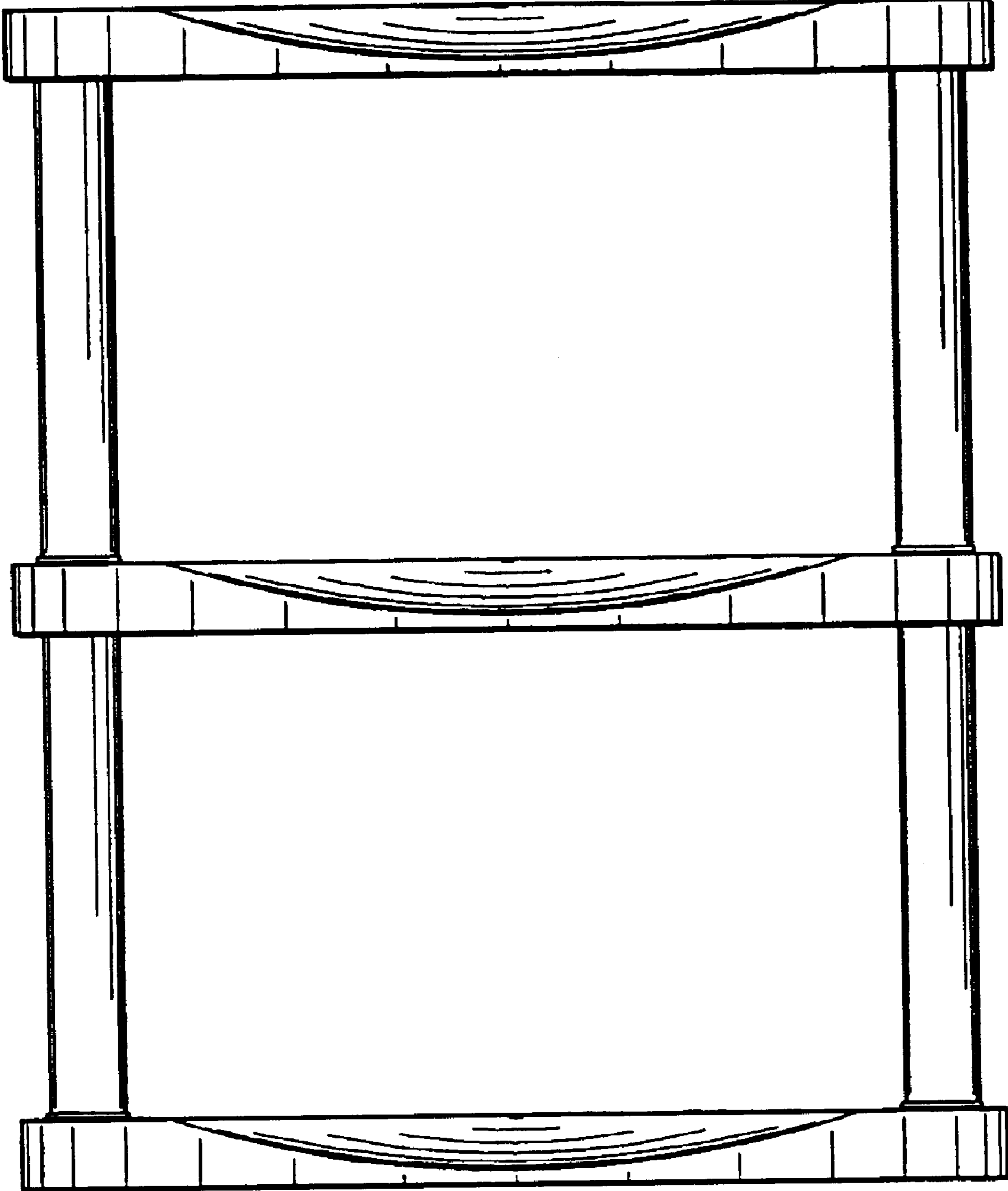

FIG. 16

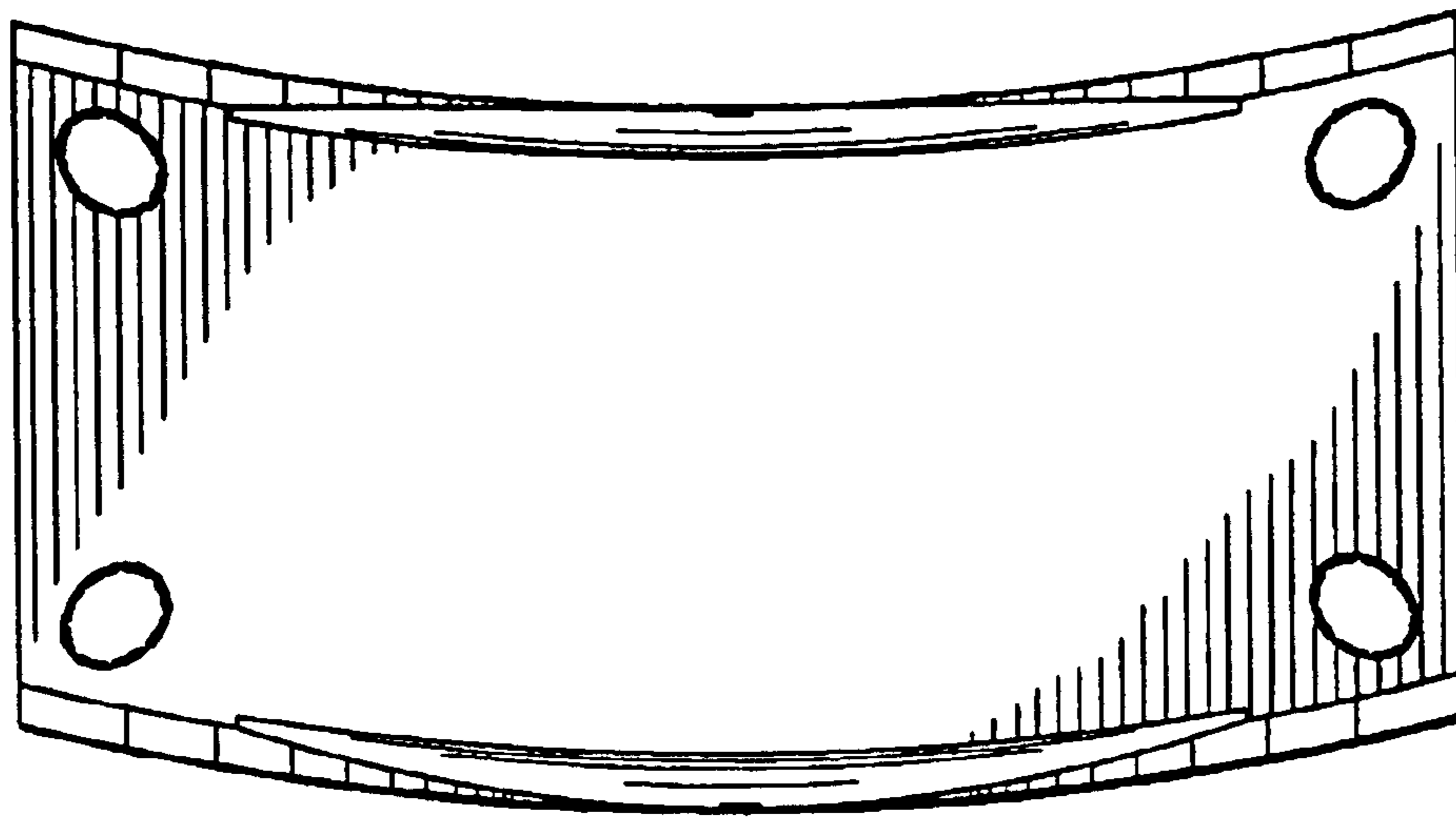

FIG. 17

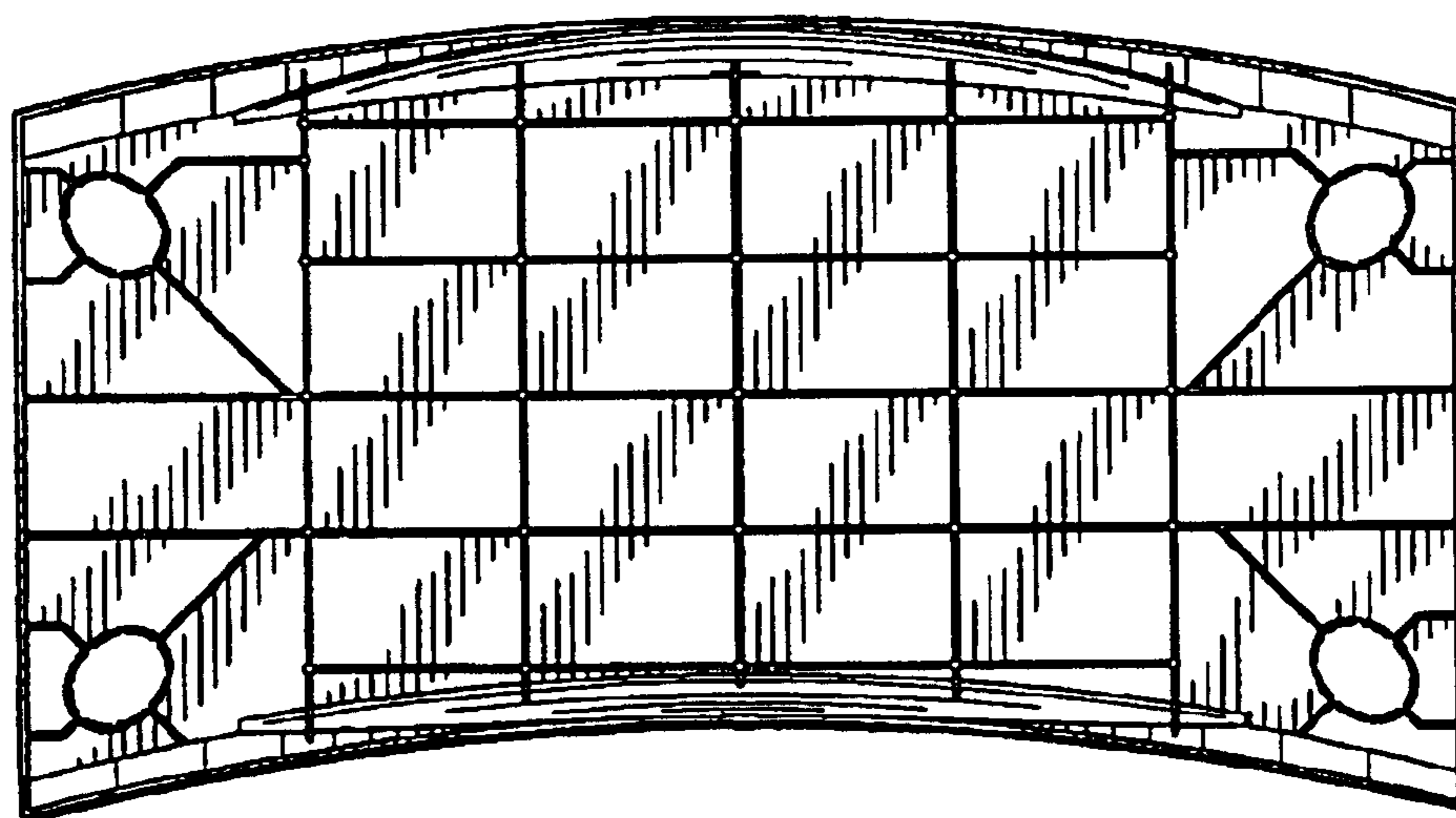

FIG. 18

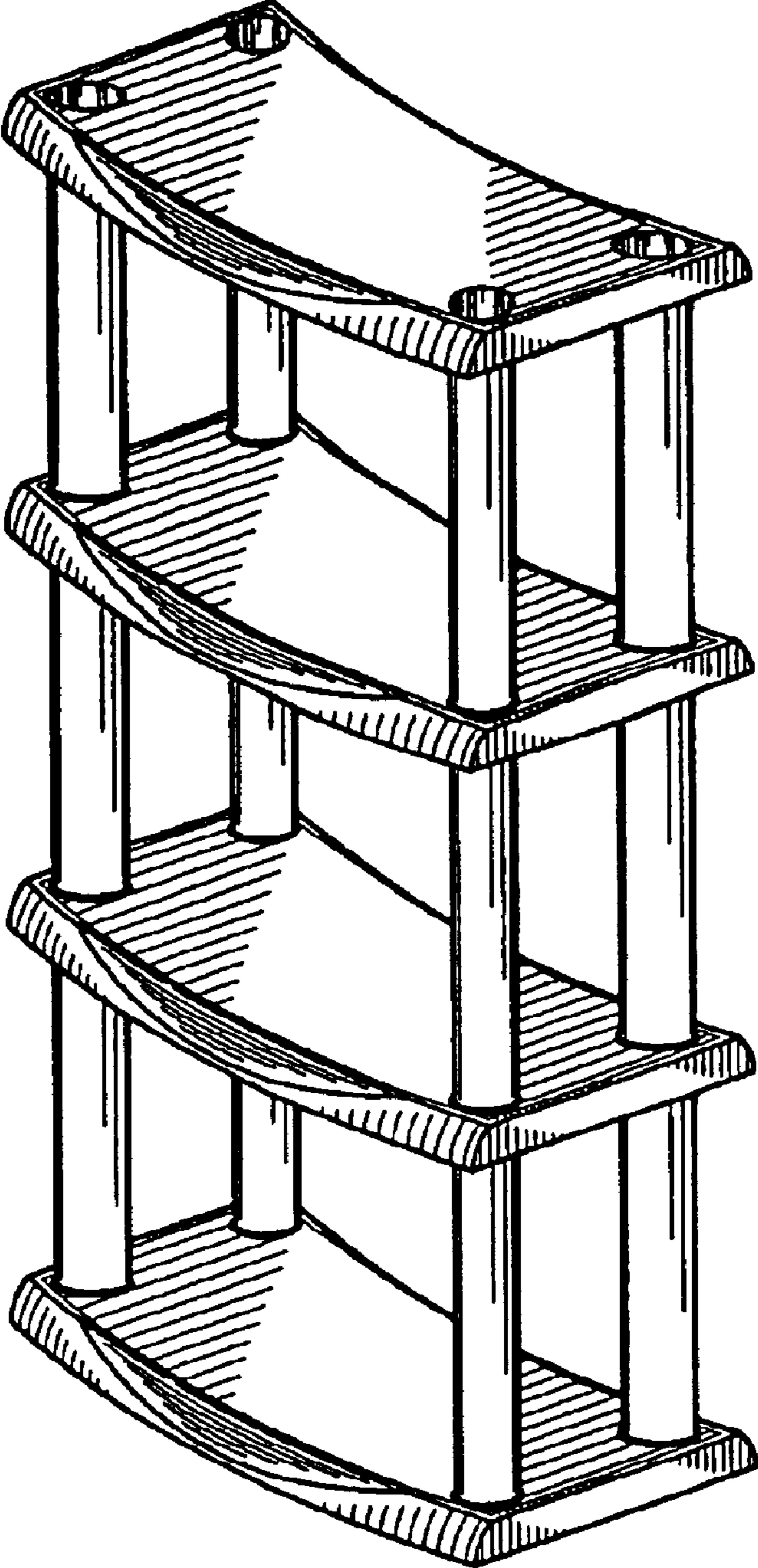

FIG. 19

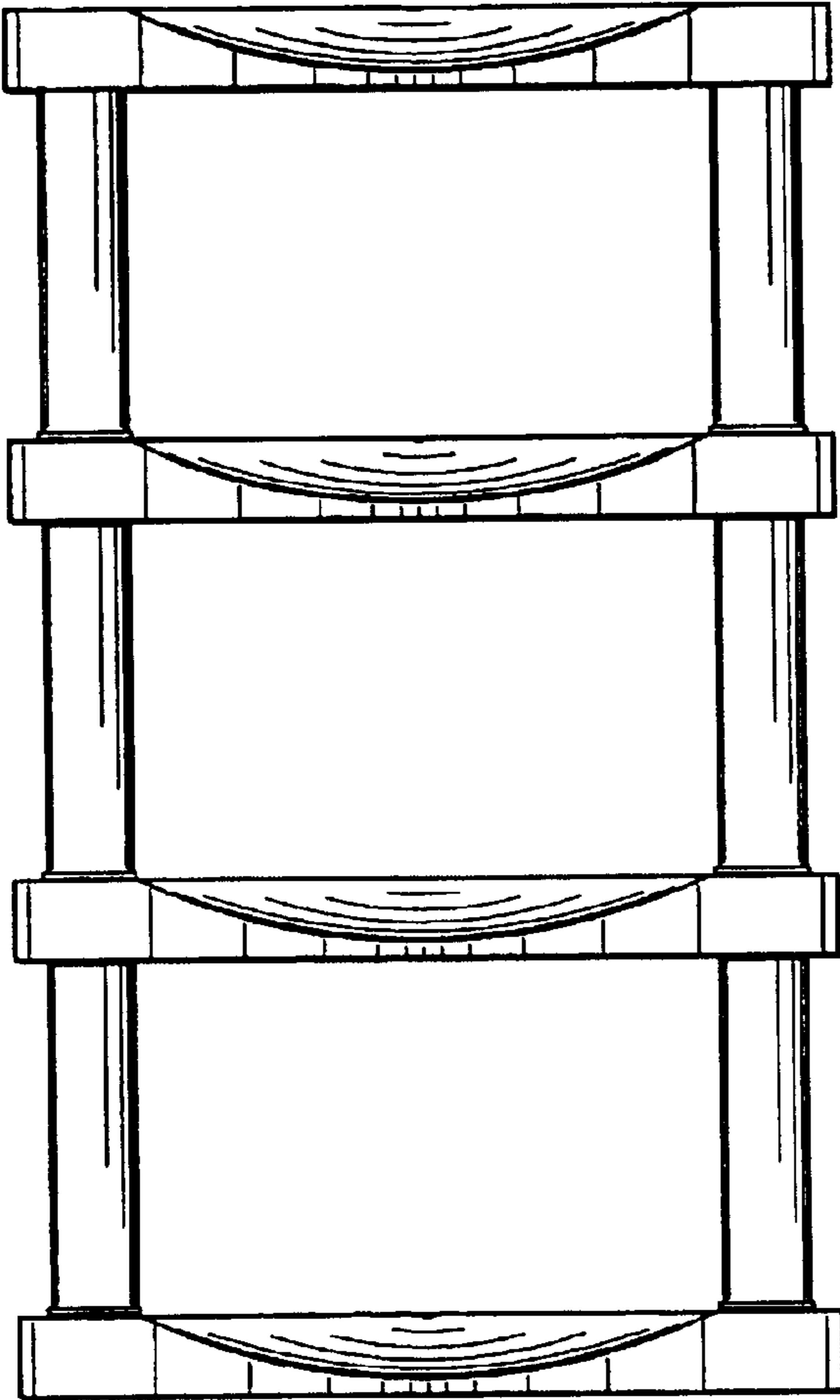

FIG. 20

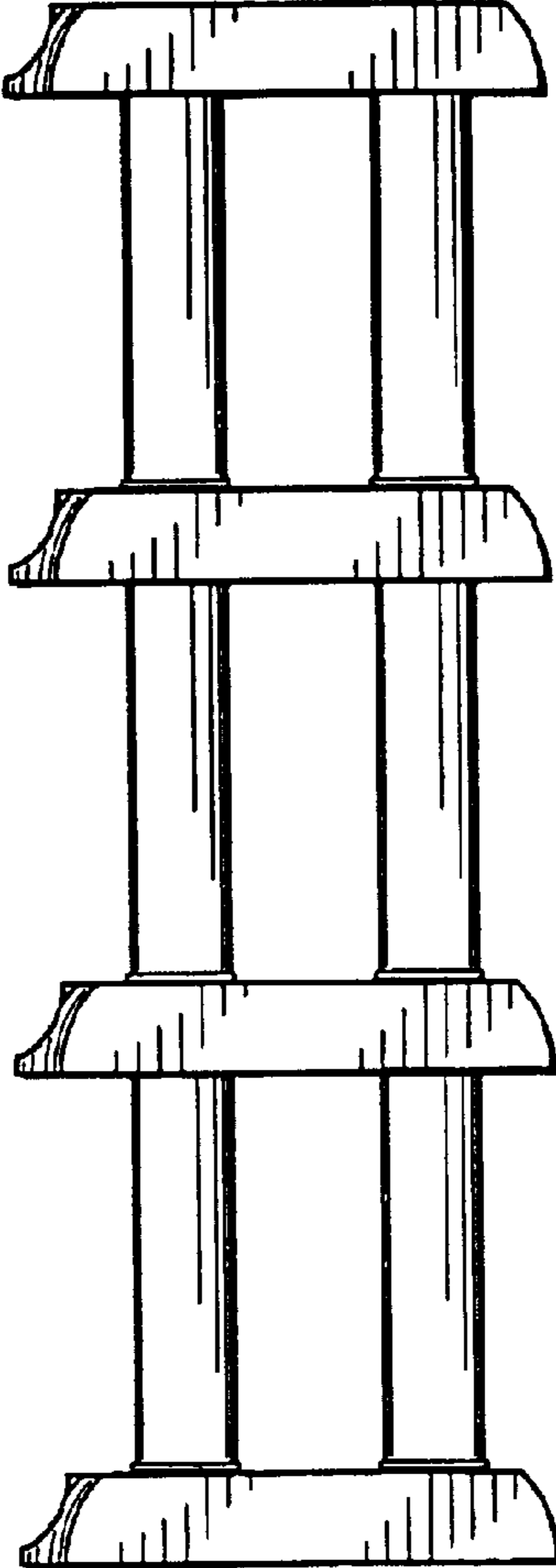

FIG. 21



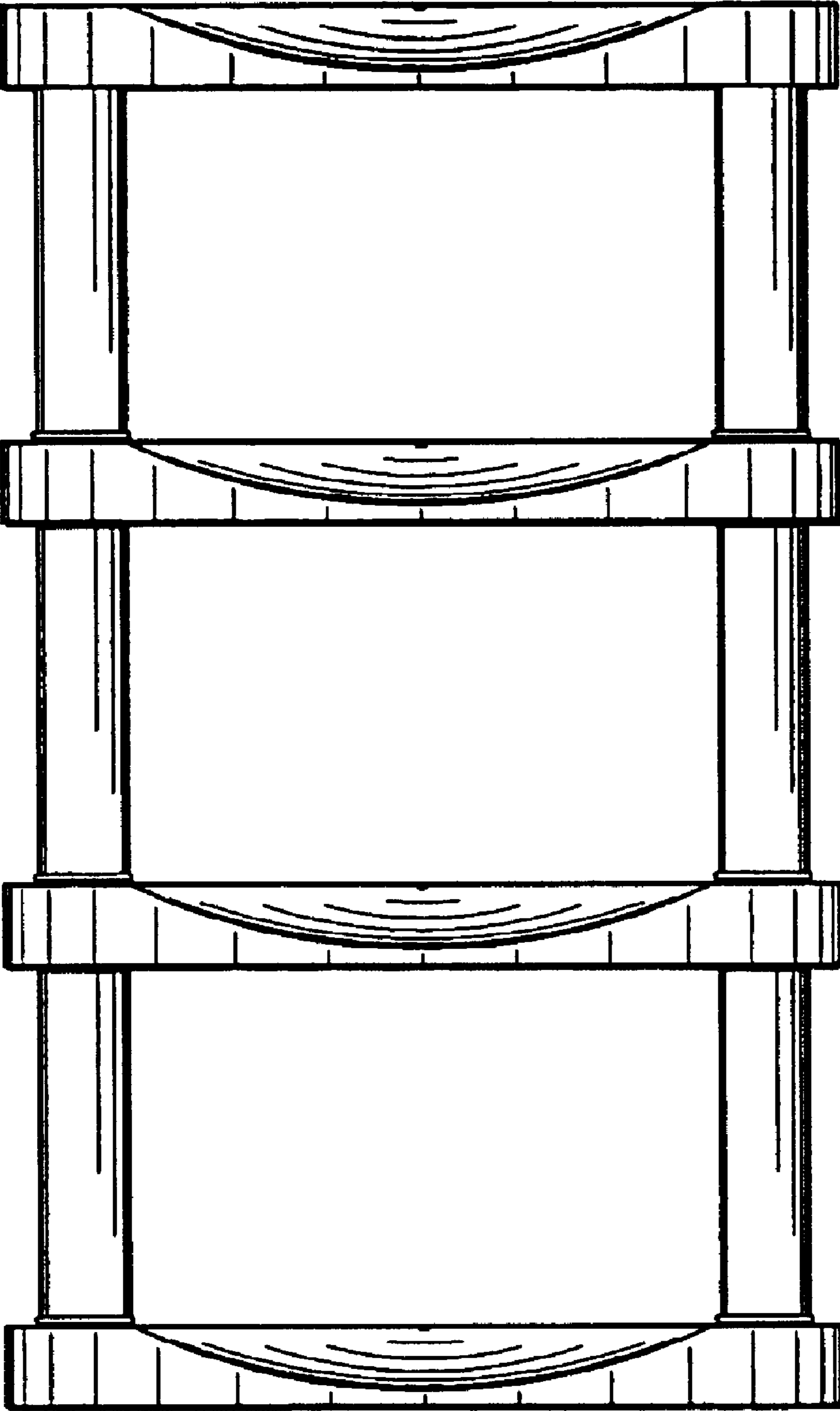

FIG. 22

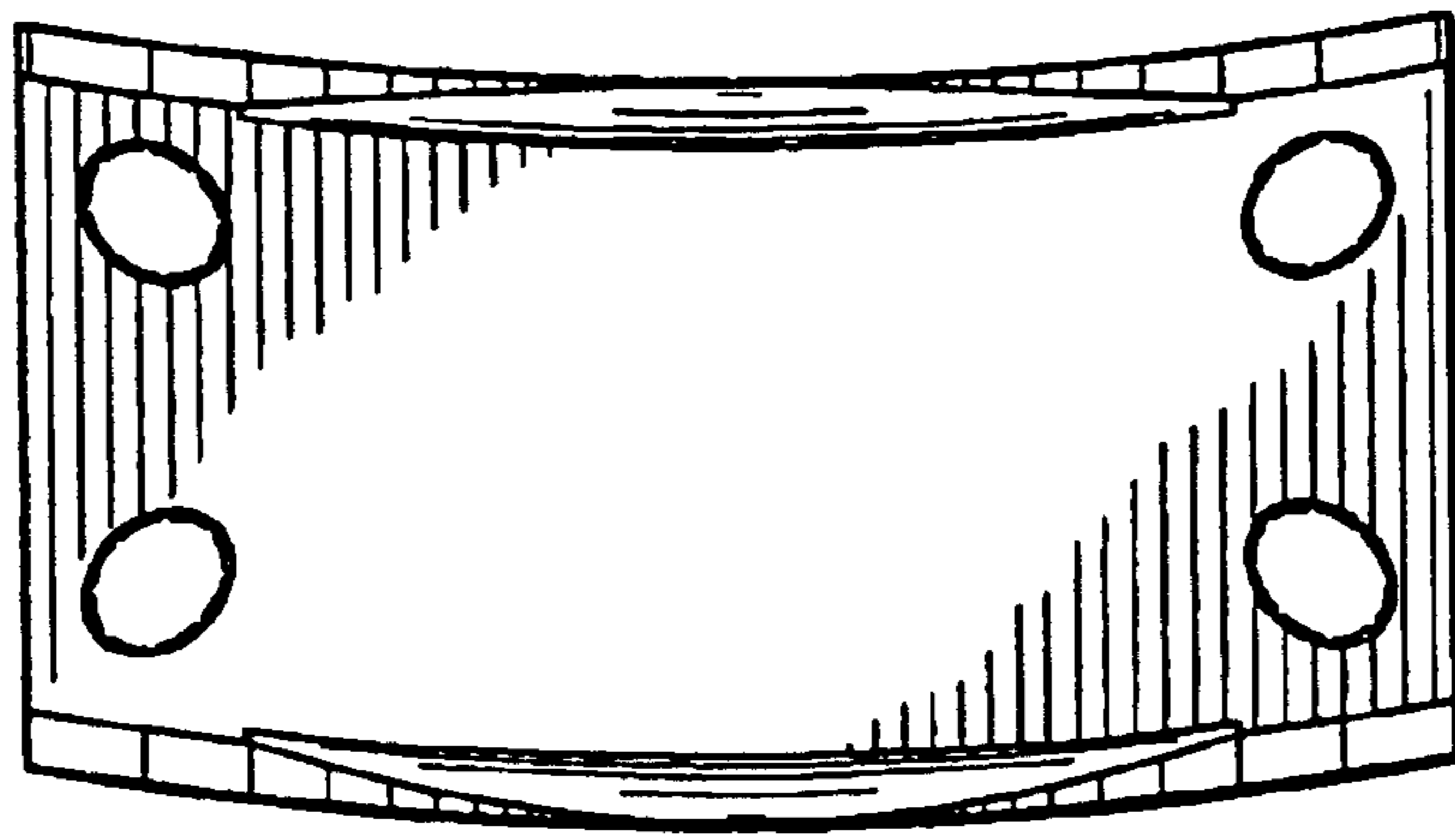

FIG. 23

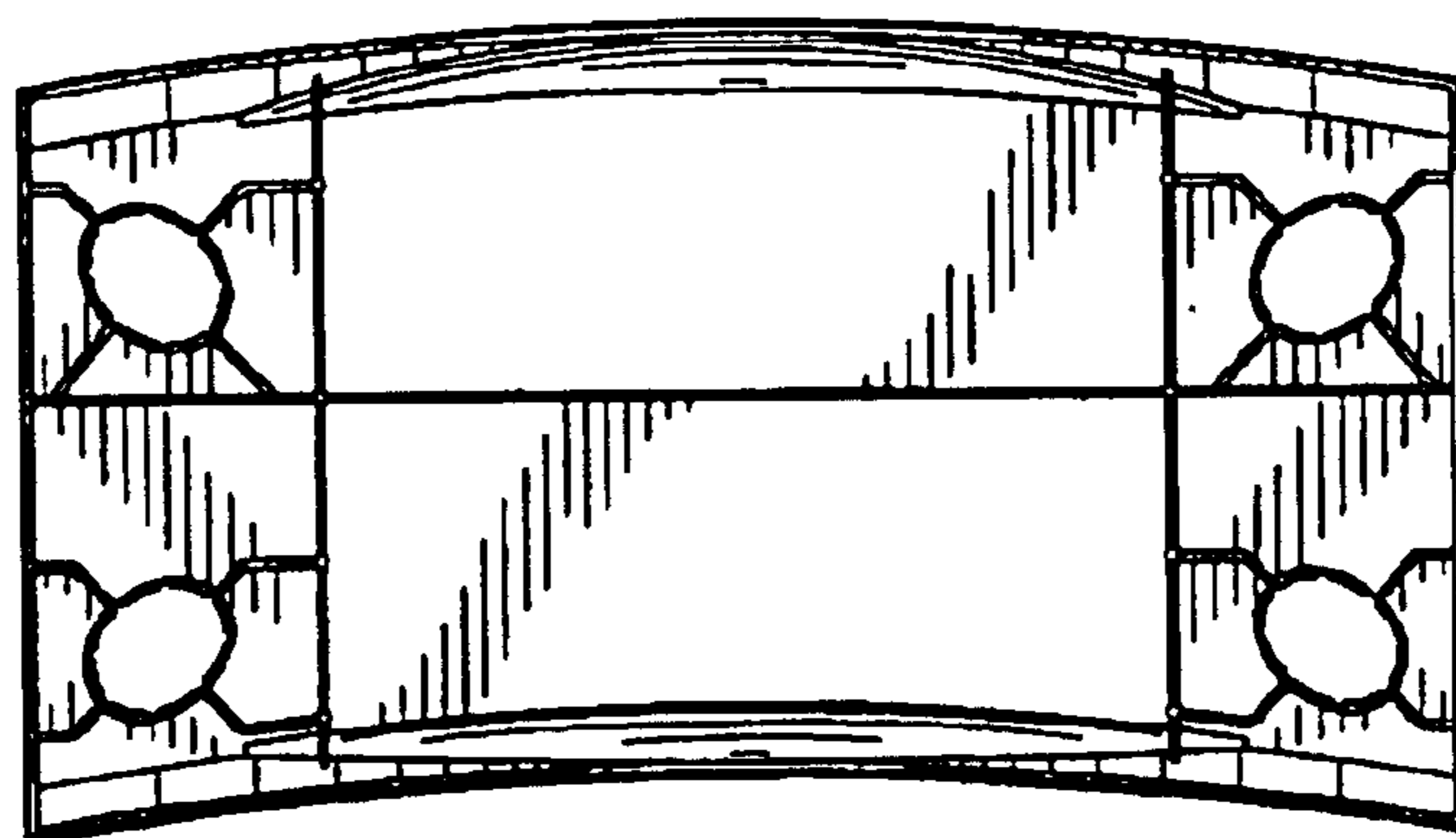

FIG. 24

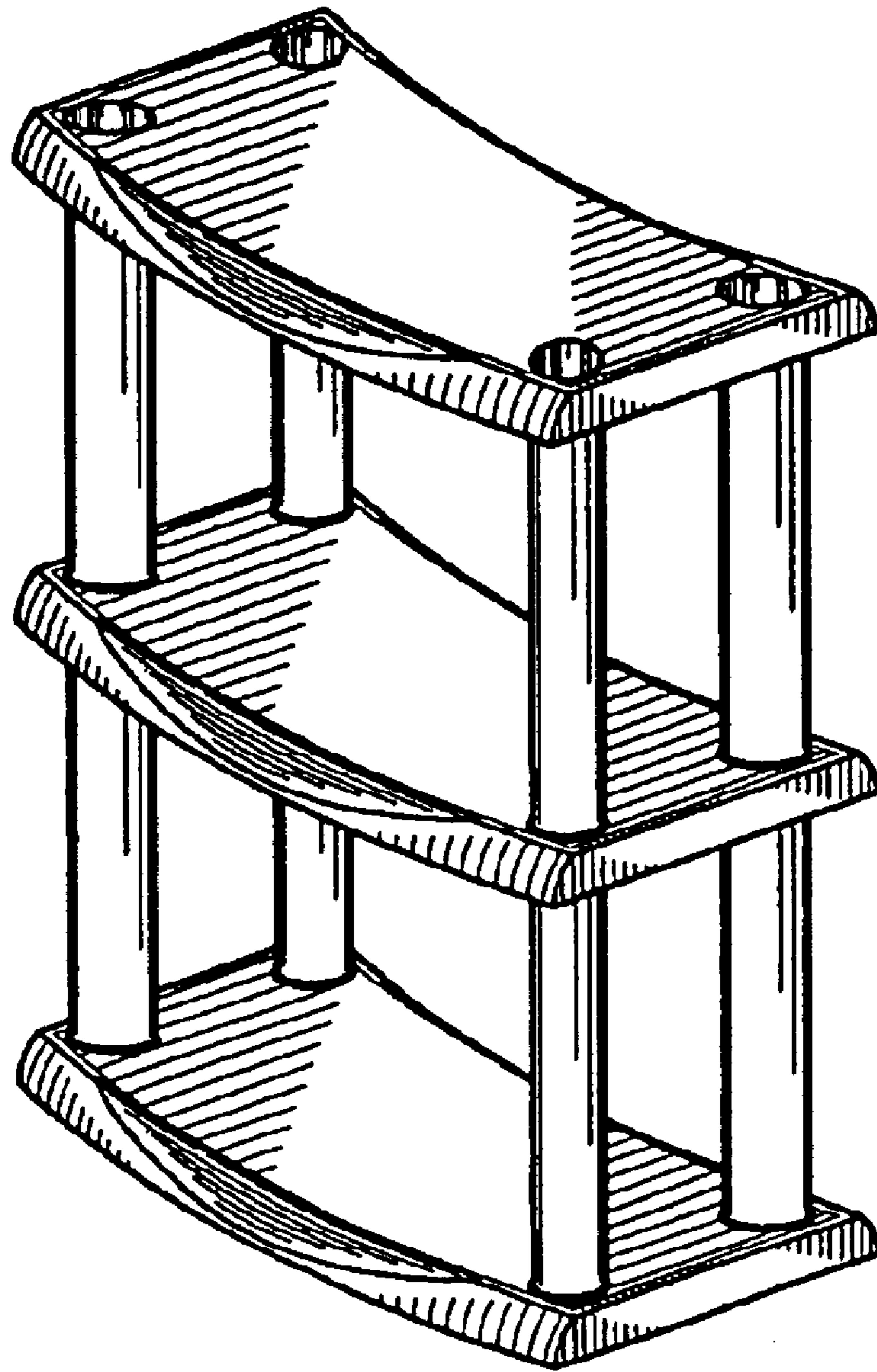

FIG. 25

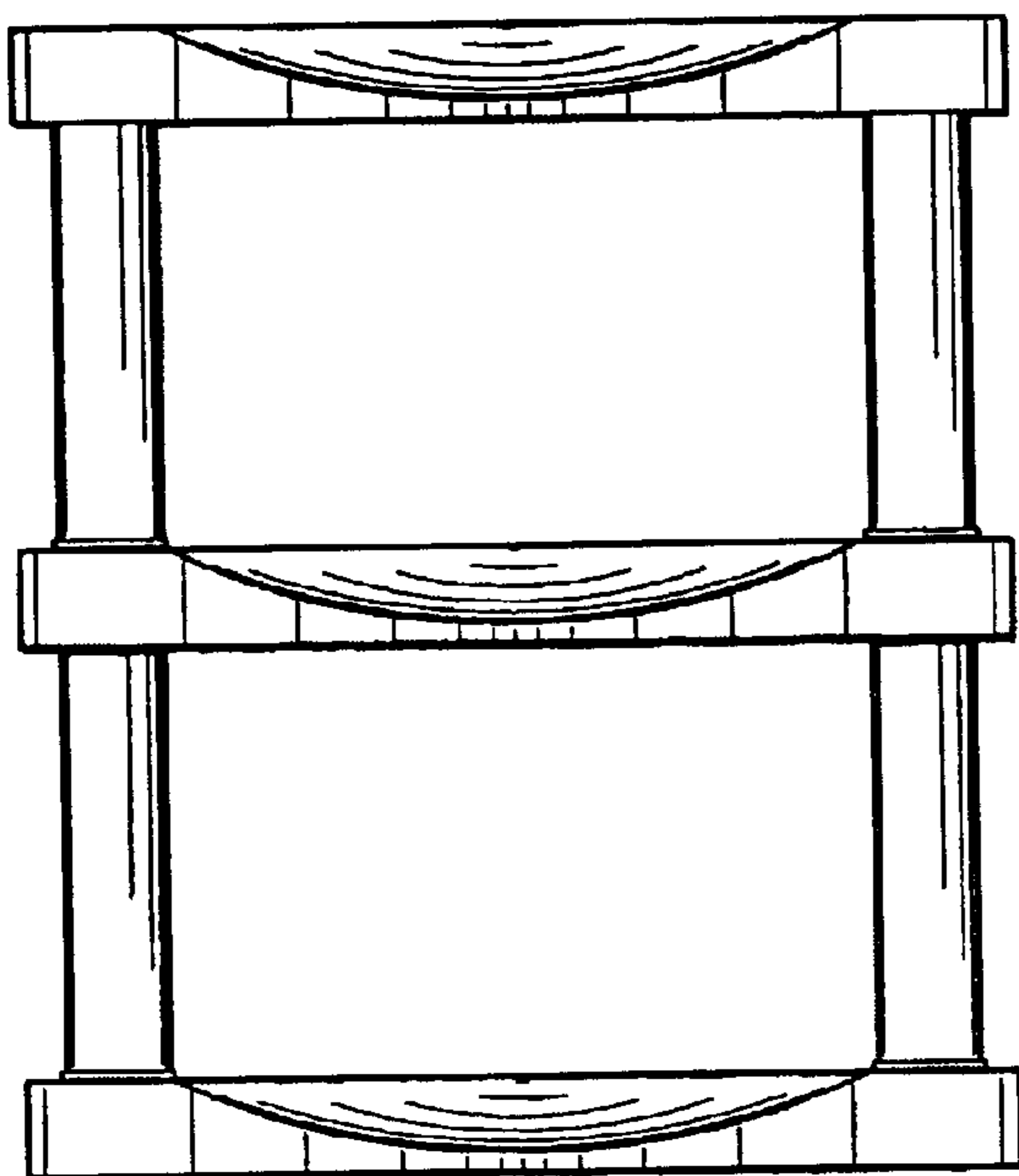

FIG. 26

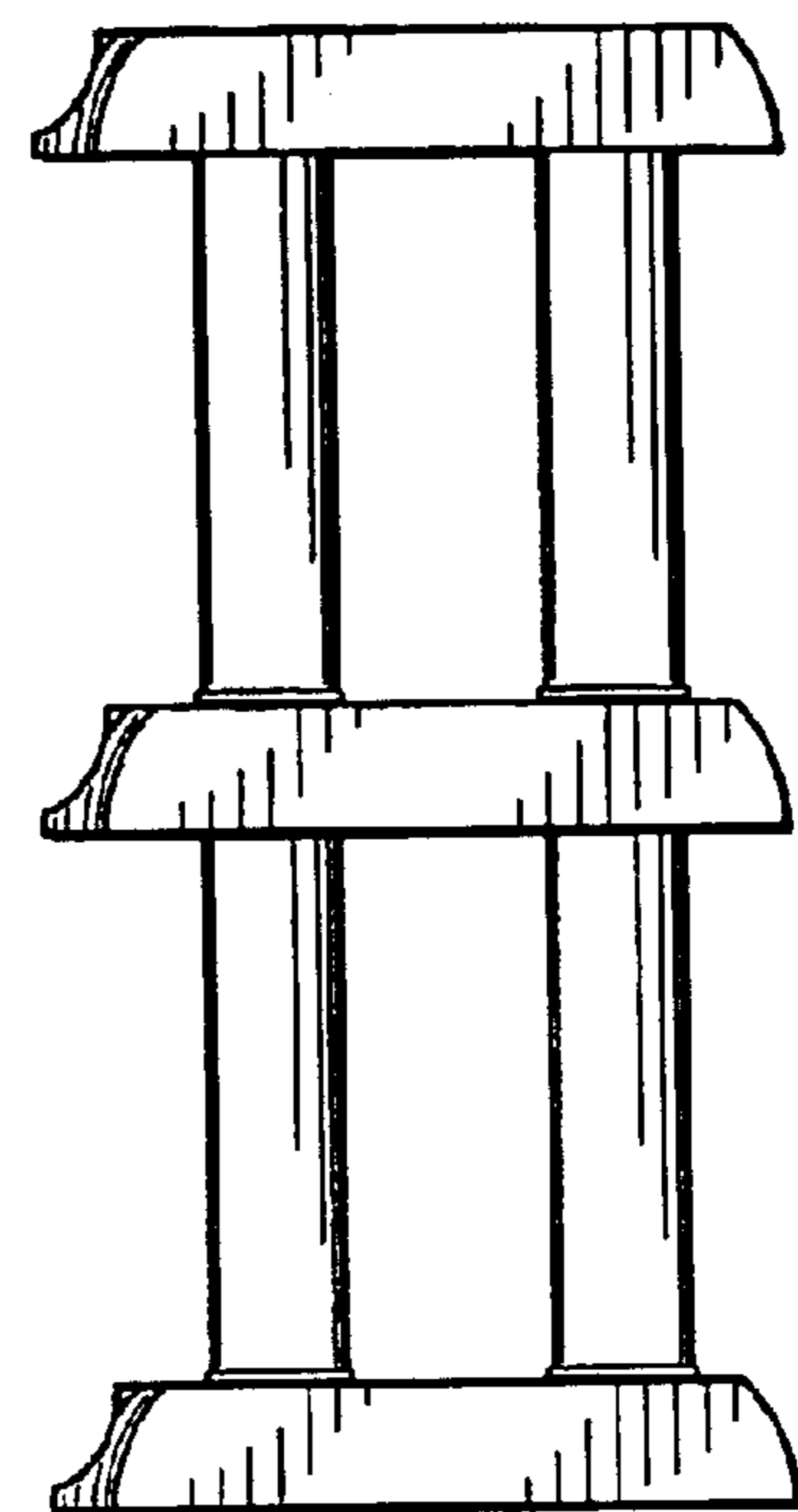

FIG. 27

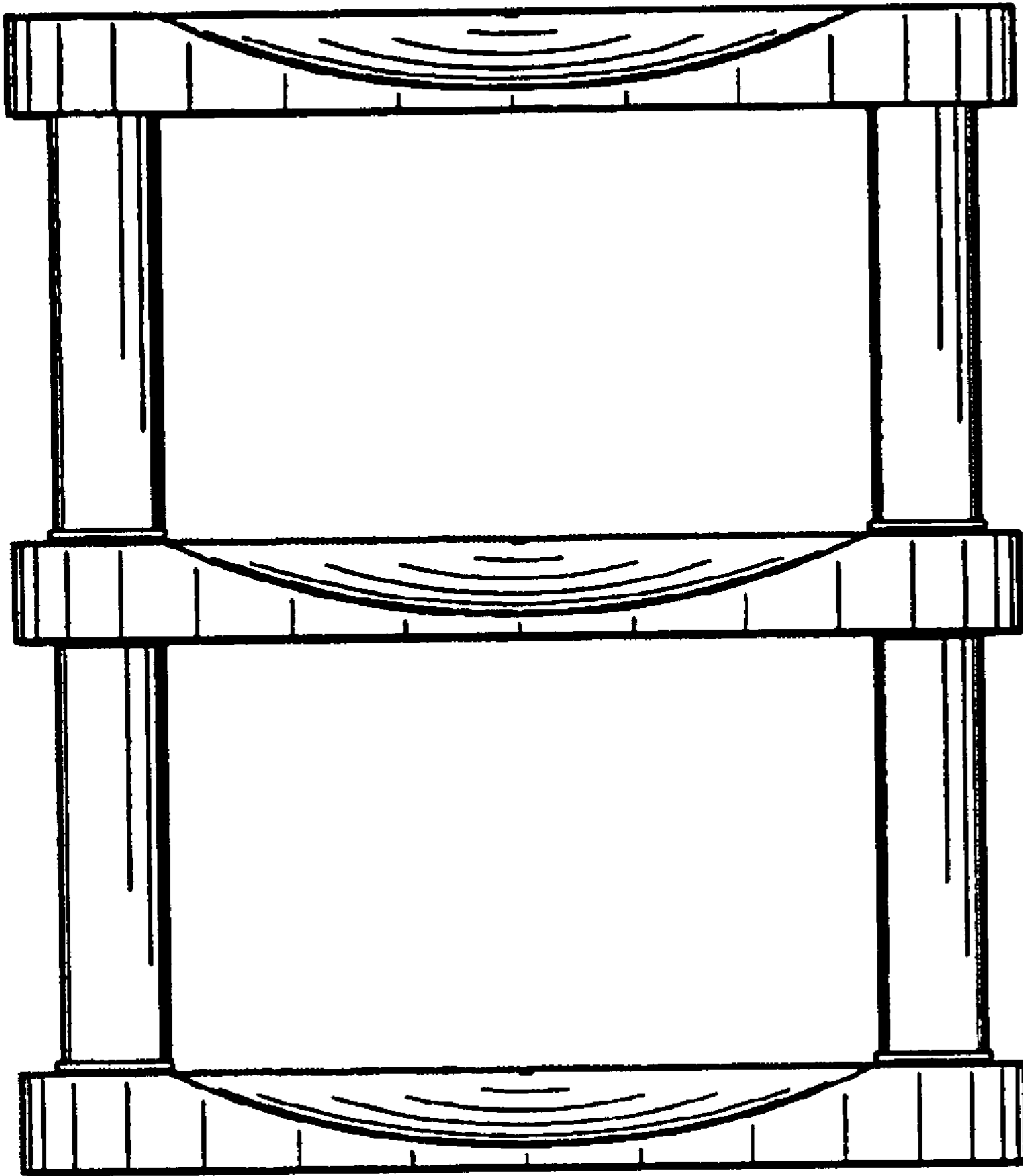

FIG. 28

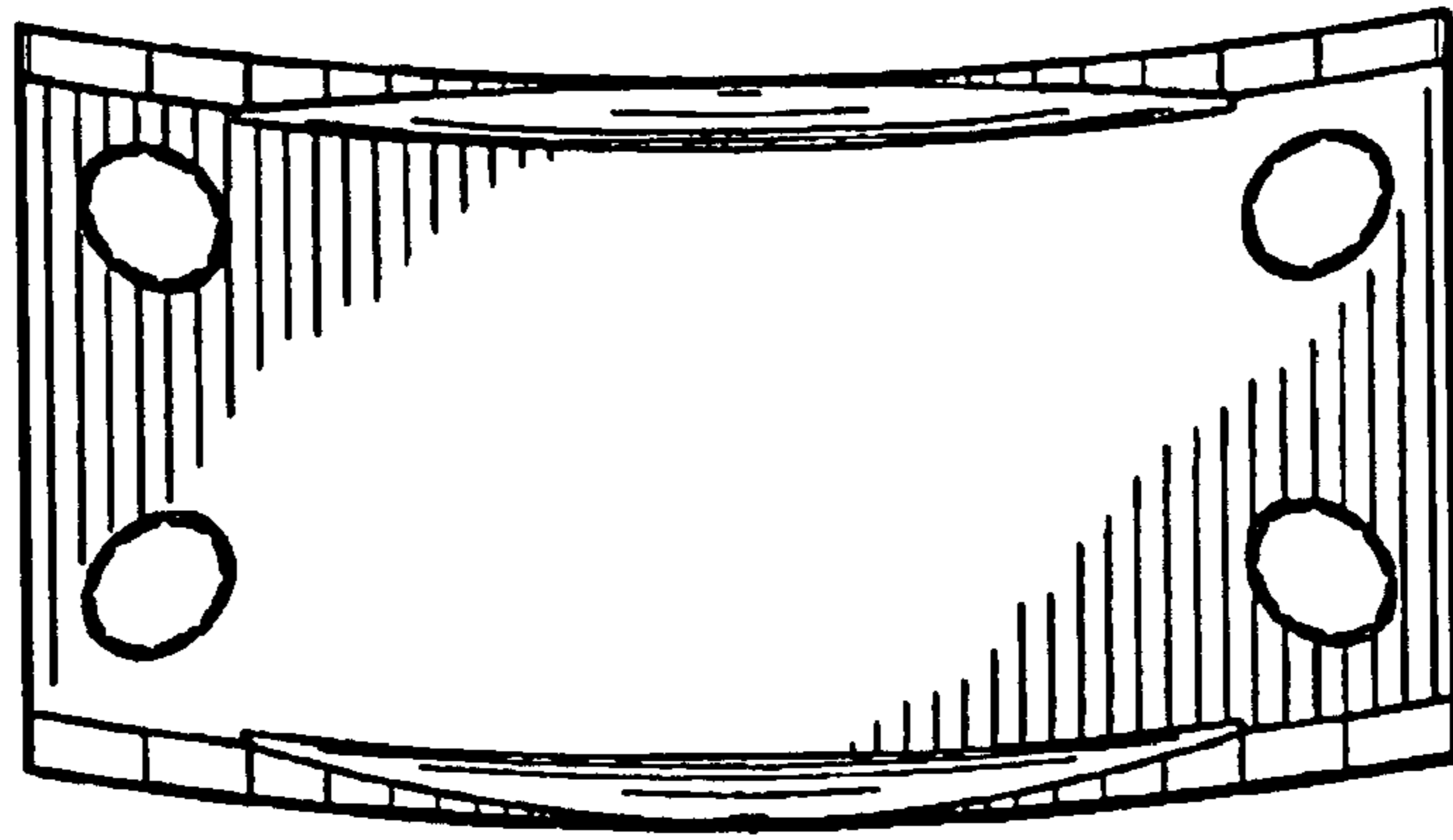

FIG. 29

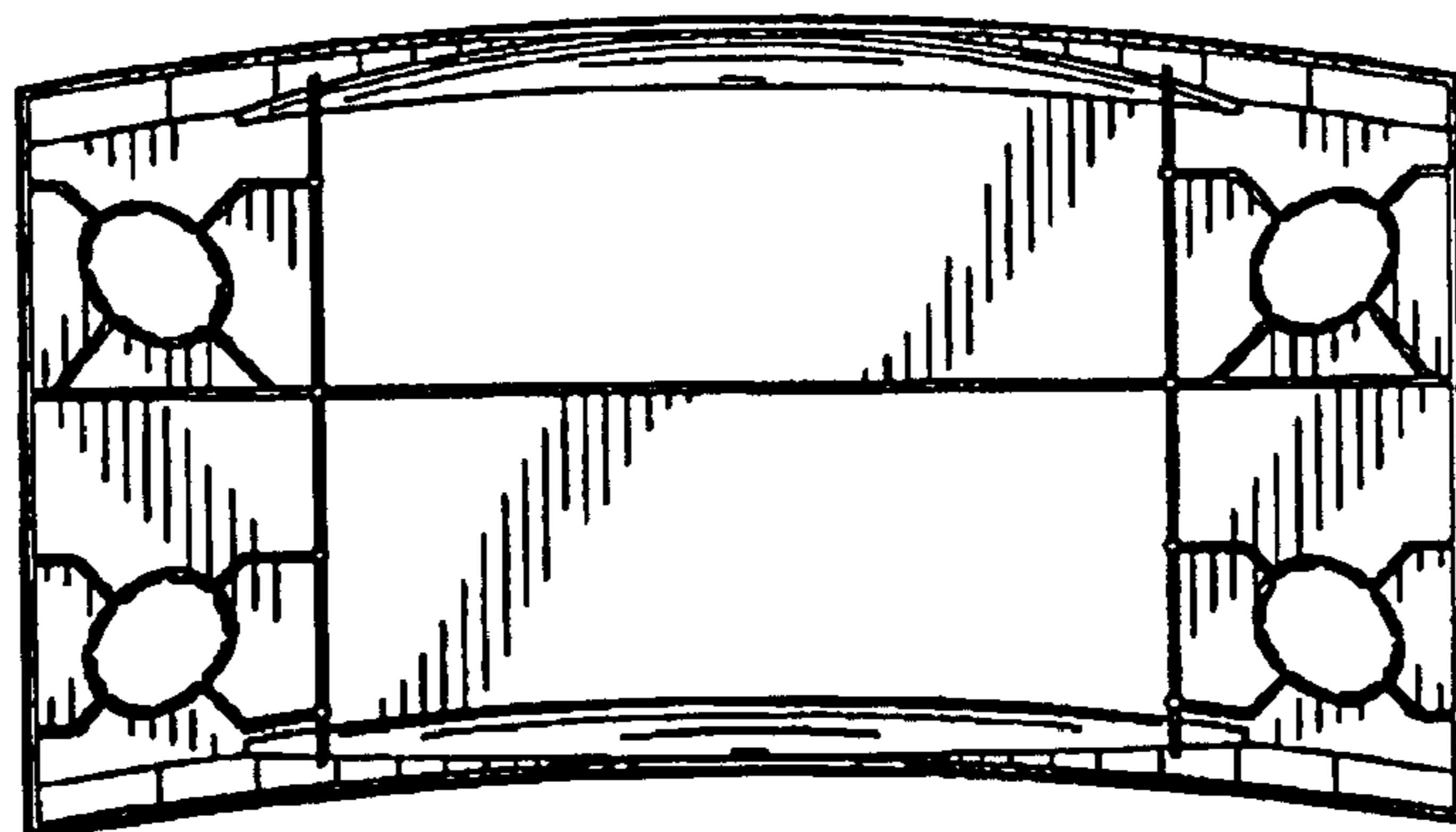

FIG. 30

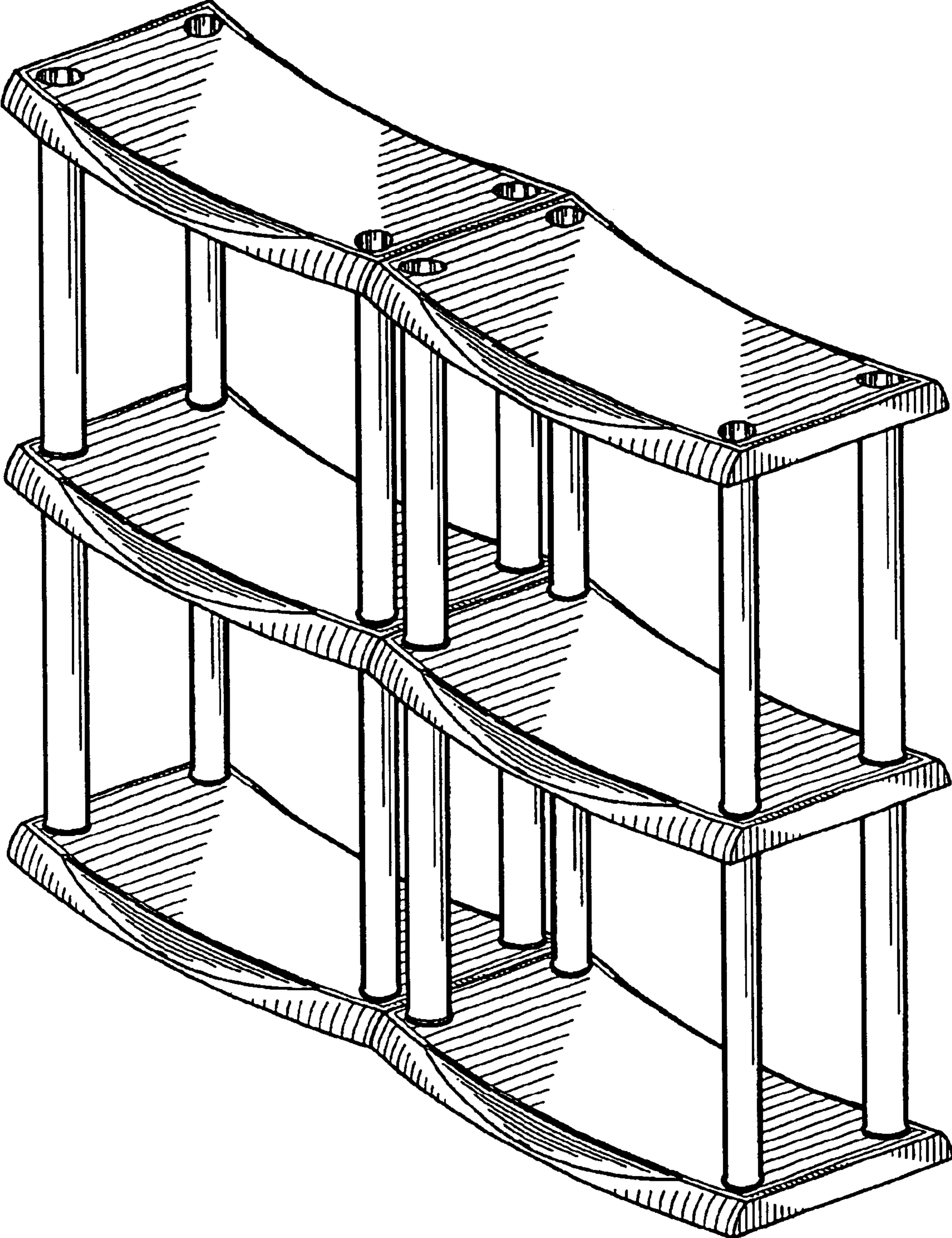

FIG. 31

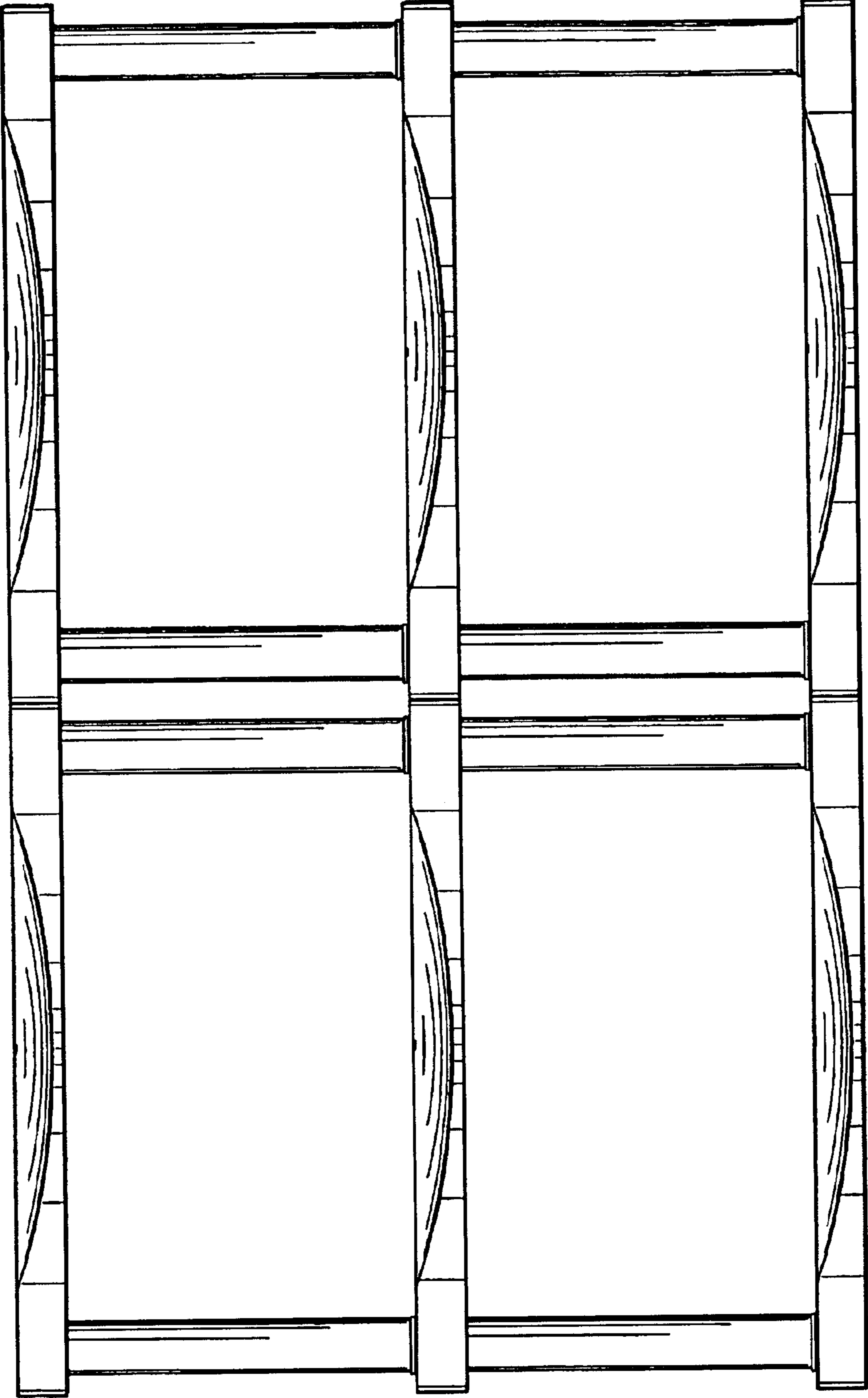

FIG. 32



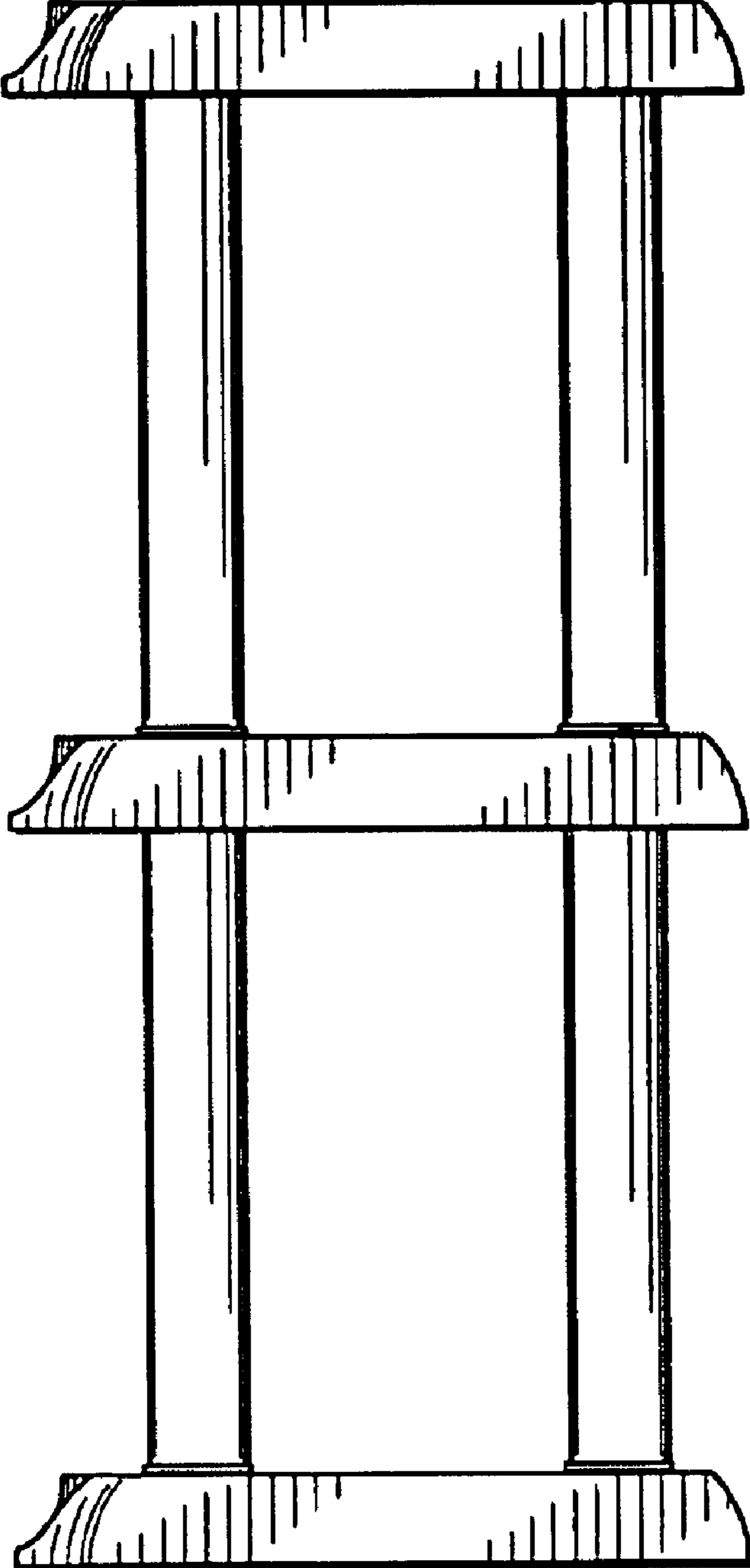

FIG. 33

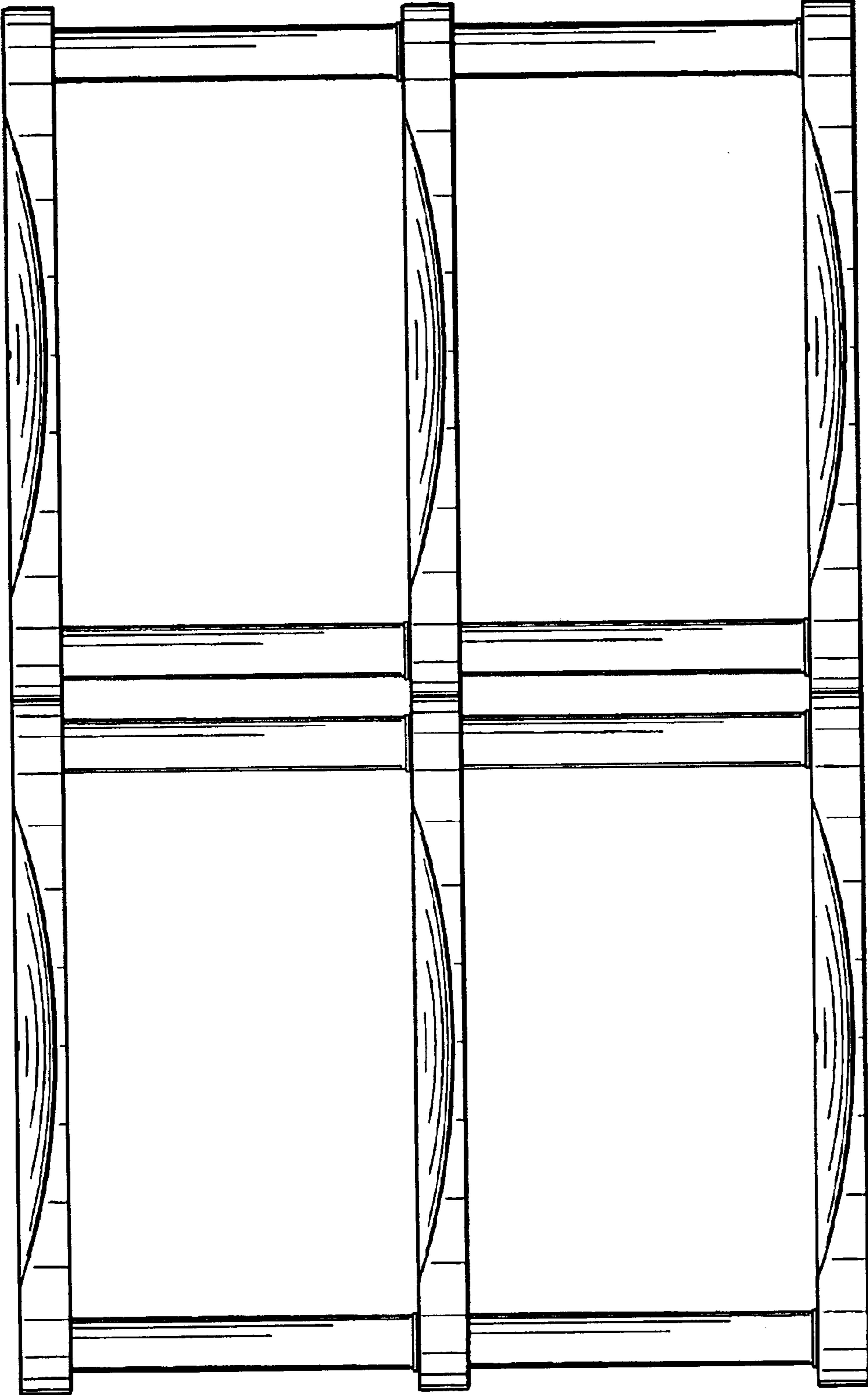

FIG. 34

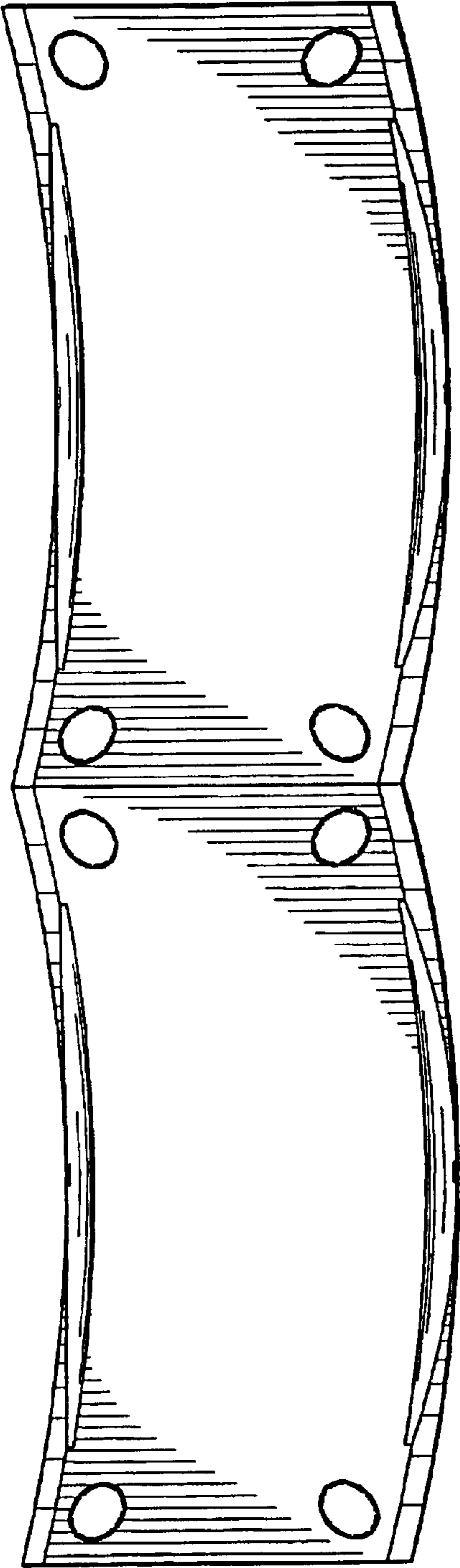

FIG. 35

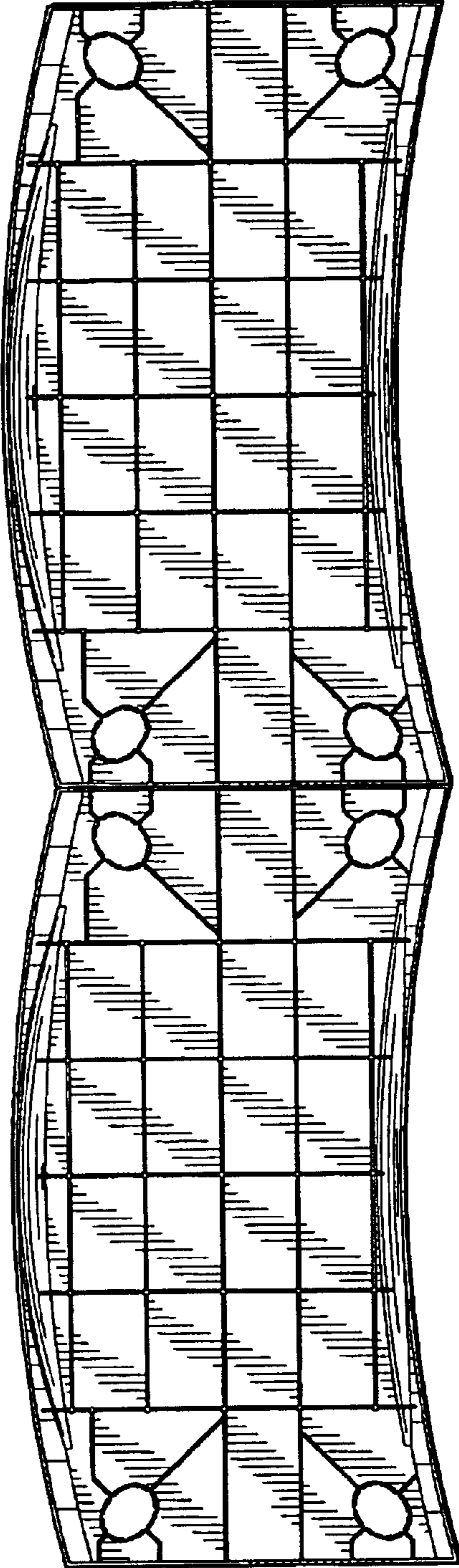

FIG. 36

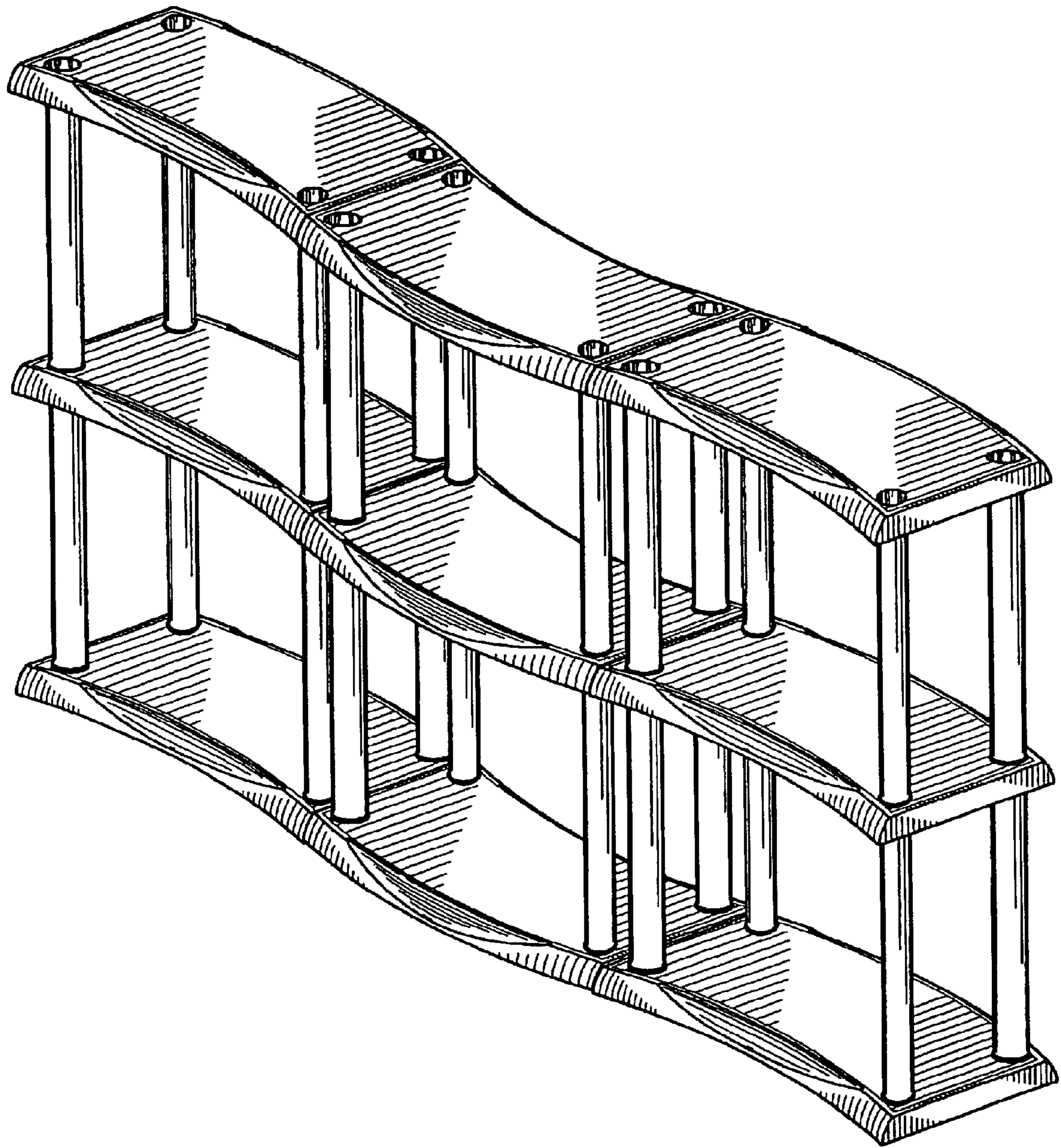

FIG. 37

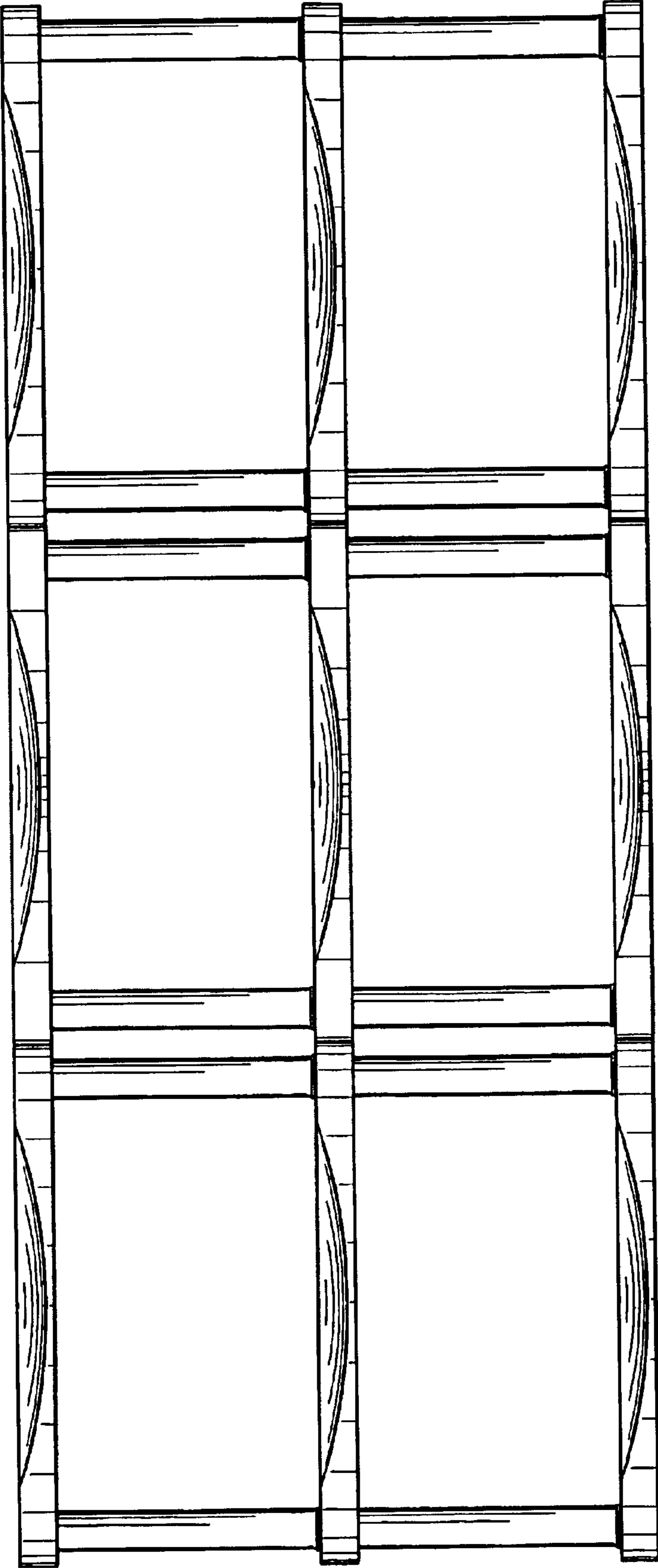

FIG. 38

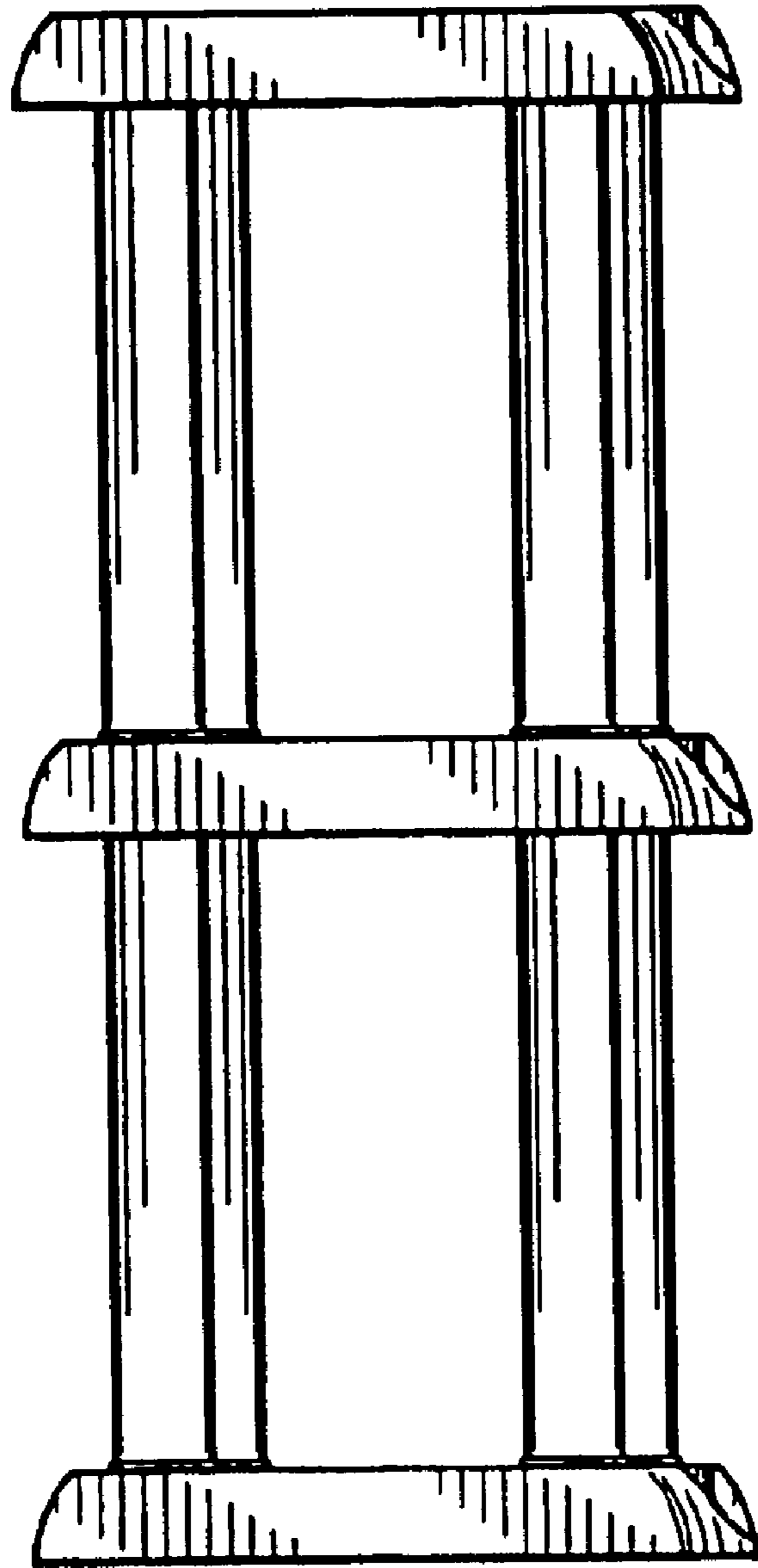

FIG. 39

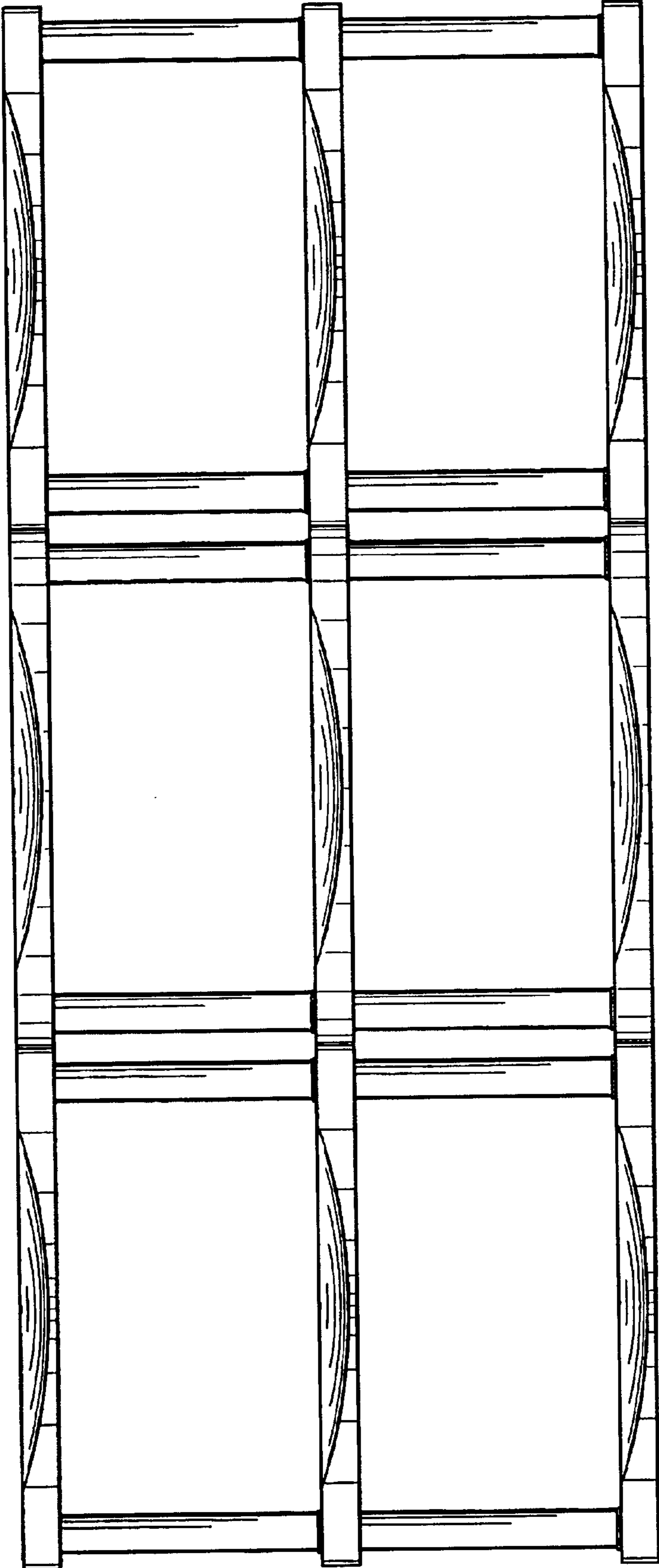

FIG. 40

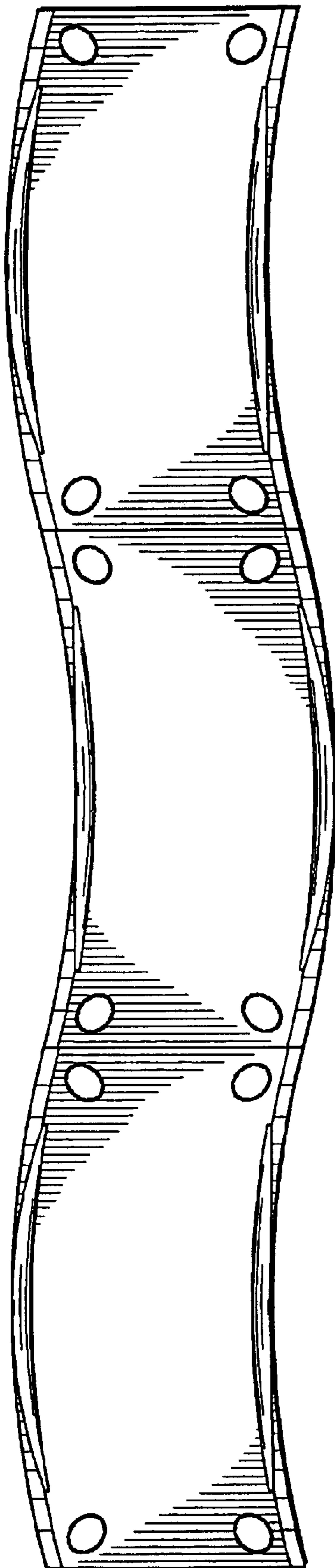

FIG. 41

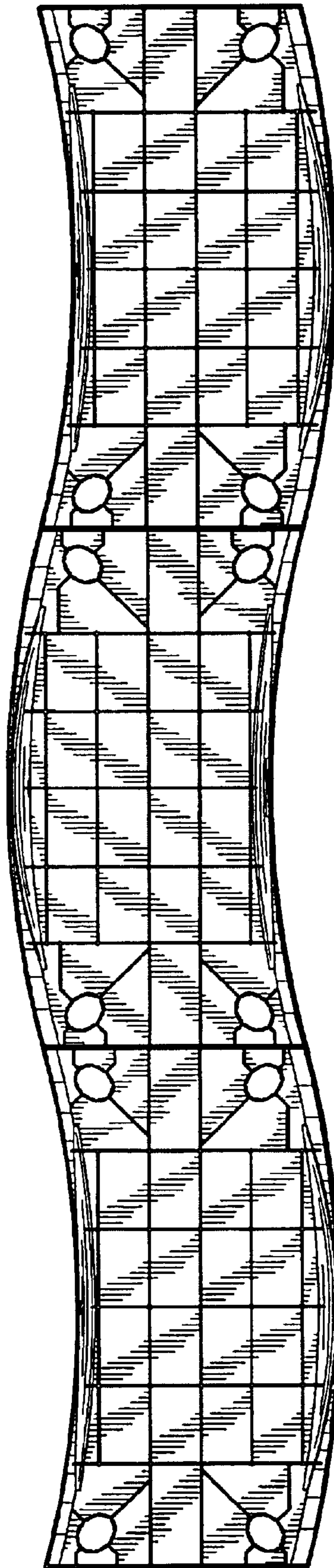

FIG. 42