

US00D501277S

(12) **United States Design Patent**  
**Goto**

(10) **Patent No.:** **US D501,277 S**  
(45) **Date of Patent:** **\*\* Jan. 25, 2005**

(54) **RAZORBLADE HOLDER**

(75) Inventor: **Shigeru Goto, Seki (JP)**

(73) Assignee: **Feather Safety Razor Co., Ltd., Osaka (JP)**

(\*\*) Term: **14 Years**

(21) Appl. No.: **29/183,484**

(22) Filed: **Jun. 13, 2003**

(30) **Foreign Application Priority Data**

Dec. 17, 2002 (JP) ..... 2002-034964  
Dec. 17, 2002 (JP) ..... 2002-034965

(51) **LOC (7) Cl.** ..... **28-03**

(52) **U.S. Cl.** ..... **D28/47**

(58) **Field of Search** ..... D28/44-48; 30/32,  
30/34.05, 34.2, 53, 526, 527, 532, 528,  
537, 541

(56) **References Cited**

**U.S. PATENT DOCUMENTS**

D377,696 S \* 1/1997 Schultz ..... D28/45  
D393,329 S 4/1998 Ido et al.  
D408,584 S \* 4/1999 Ido et al. .... D28/45  
6,701,619 B2 \* 3/2004 Haruyuki ..... 30/47  
2002/0189105 A1 \* 12/2002 Kitano ..... 30/53

\* cited by examiner

*Primary Examiner*—Jennifer Rivard

(74) *Attorney, Agent, or Firm*—Plumsea Law Group, LLC

(57) **CLAIM**

The ornamental design for a razorblade holder, as shown and described.

**DESCRIPTION**

FIG. 1 is a front view showing a razorblade holder according to a first embodiment of the present invention, the rear view being a mirror image thereof;

FIG. 2 is a top plan view thereof;

FIG. 3 is a bottom plan view thereof;

FIG. 4 is a right side view thereof;

FIG. 5 is a left side view thereof;

FIG. 6 is an enlarged right side view thereof;

FIG. 7 is an enlarged left side view thereof;

FIG. 8 is an enlarged cross-sectional view taken along line 8—8 in FIG. 1;

FIG. 9 is an enlarged cross-sectional view taken along line 9—9 in FIG. 1;

FIG. 10 is an enlarged partial view showing section 10 in FIG. 1;

FIG. 11 is an enlarged partial view showing section 11 in FIG. 3;

FIG. 12 is a perspective view thereof; and,

FIG. 13 is a referential front view showing the razorblade holder of FIG. 1 in a state holding a razorblade and connected to a handle.

The broken lines in the drawings are shown for illustrative purposes only and form no part of the claimed design.

**1 Claim, 4 Drawing Sheets**

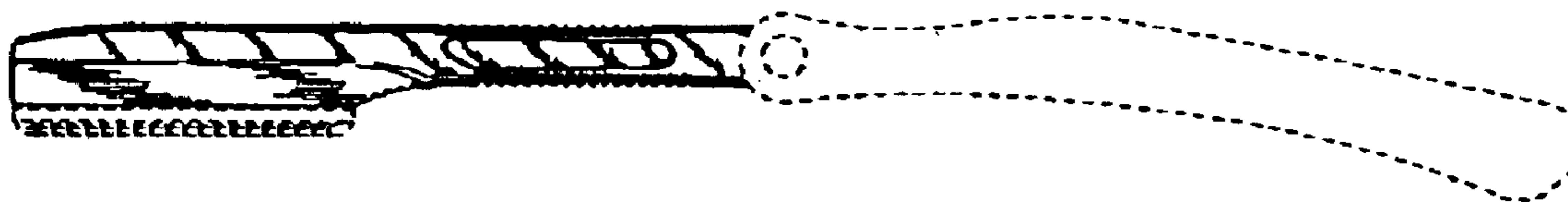

**FIG.1**

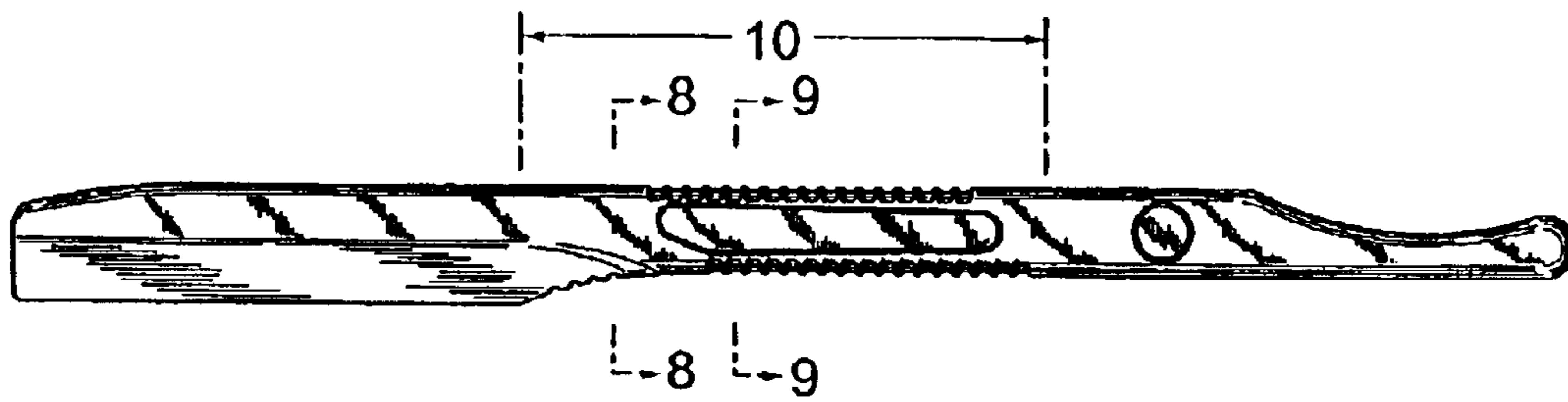

**FIG.2**



**FIG.3**



**FIG.4**



**FIG.5**



**FIG.6**

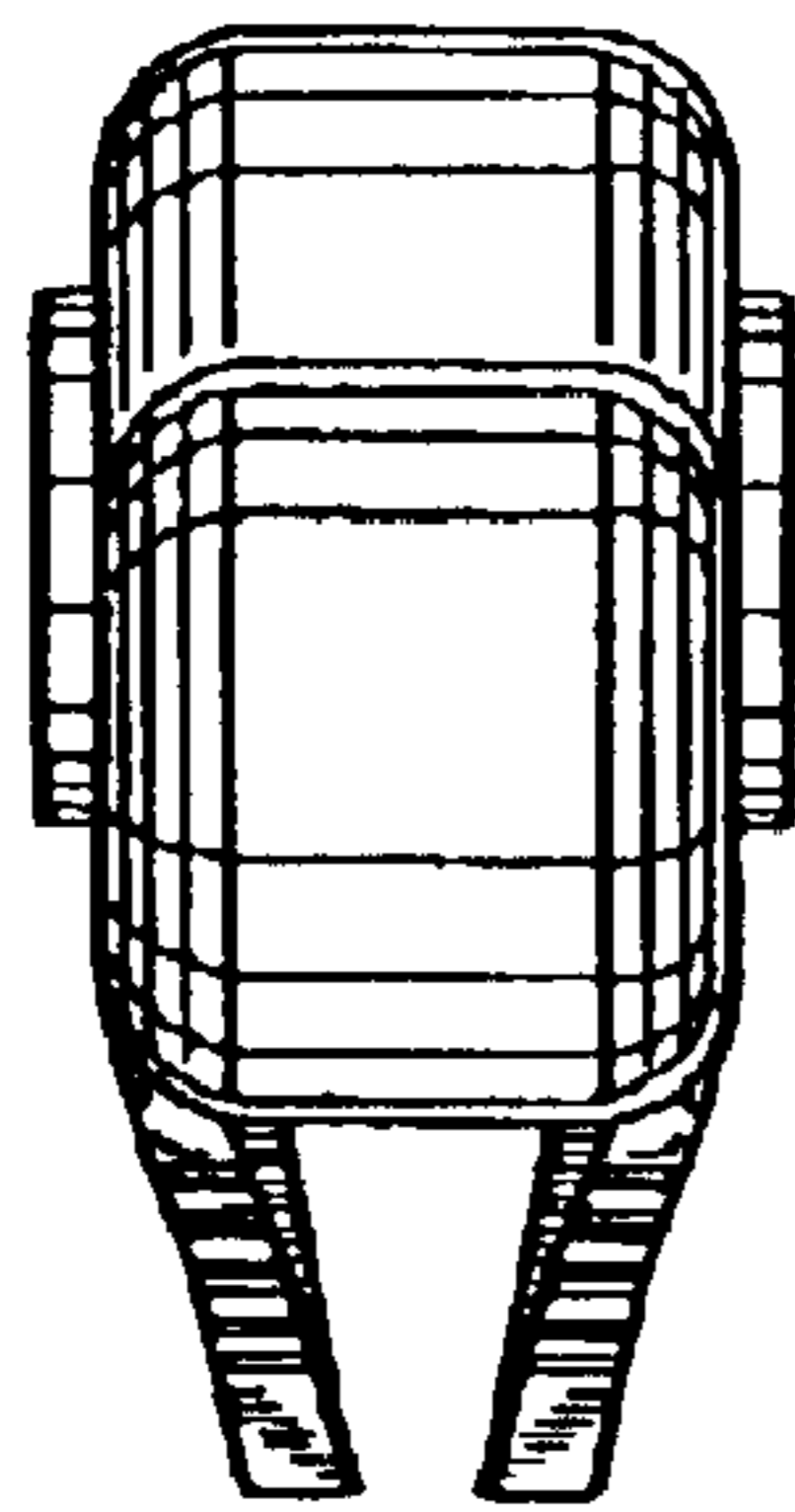

**FIG.7**

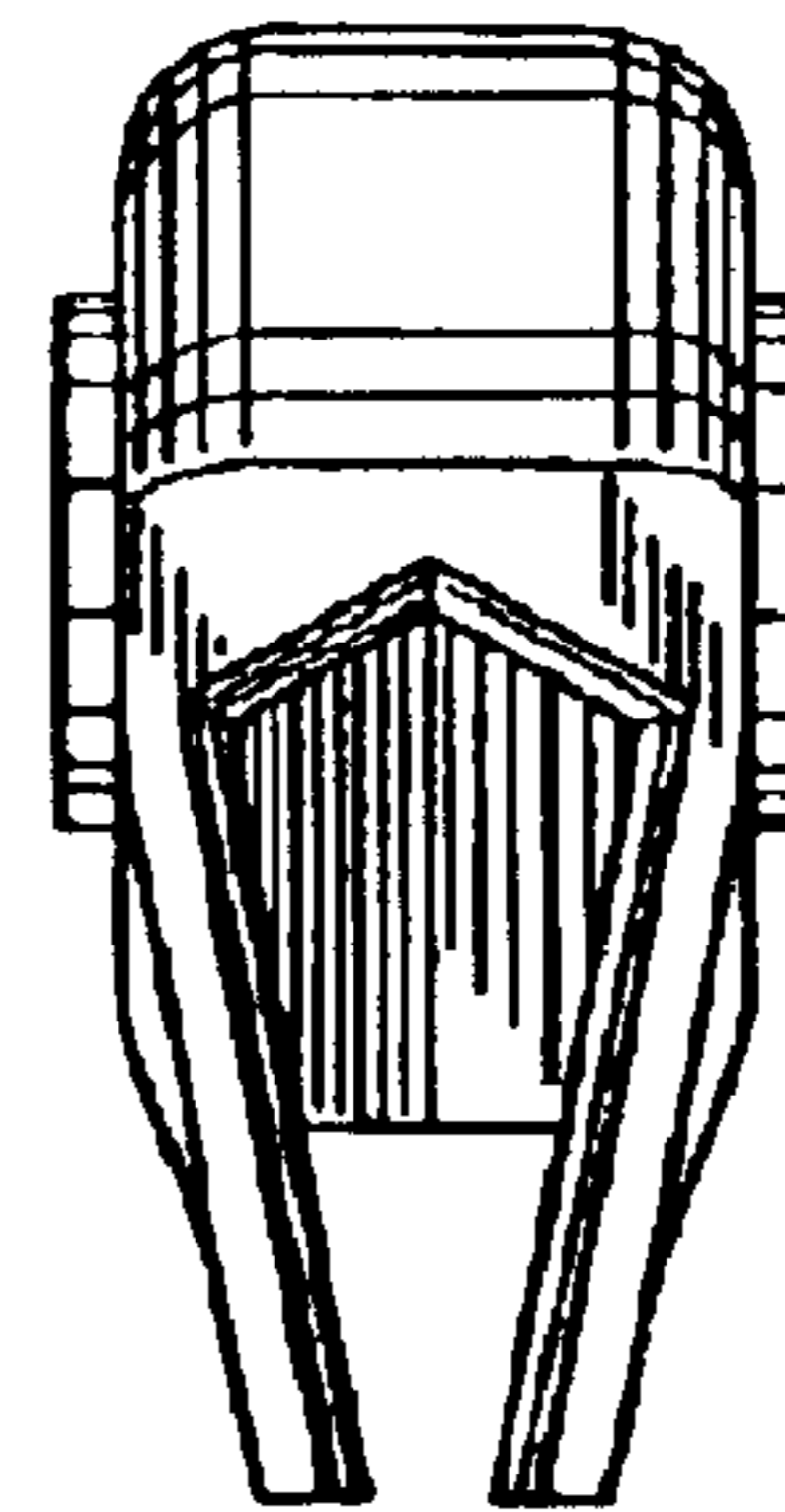

**FIG.8**

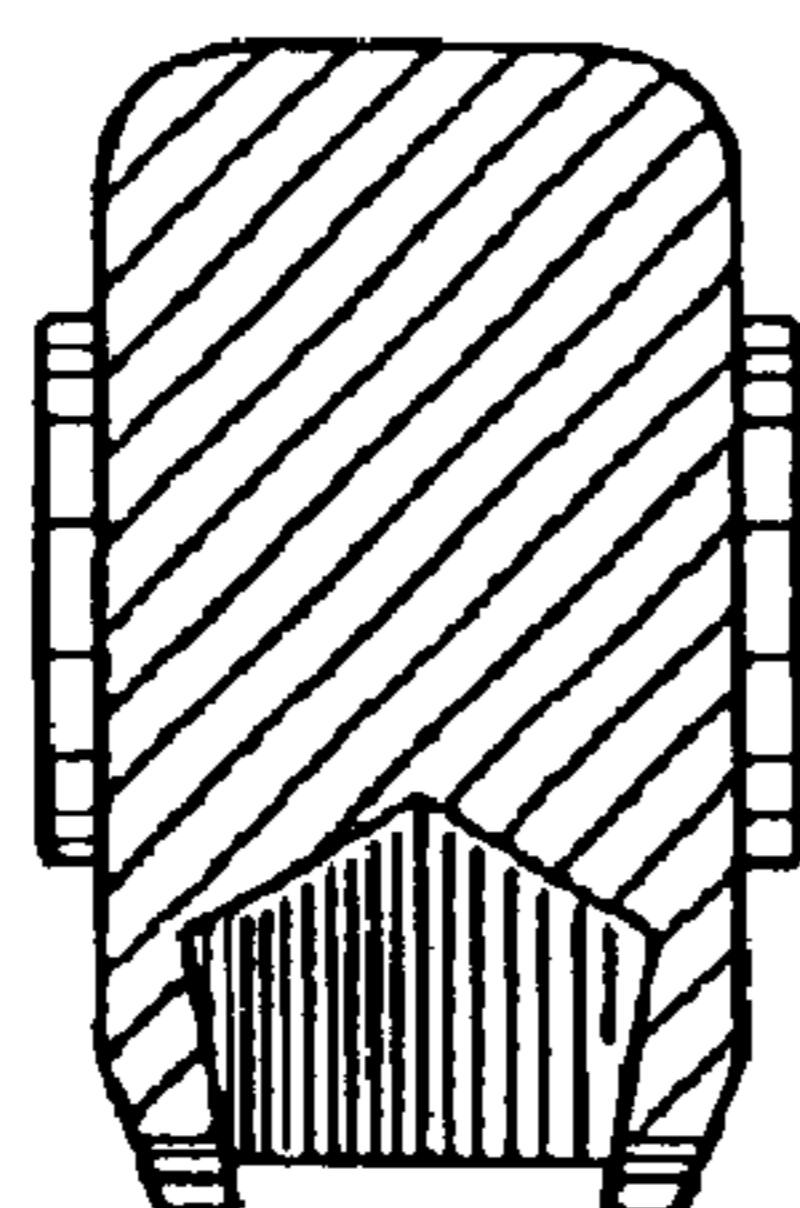

**FIG.9**

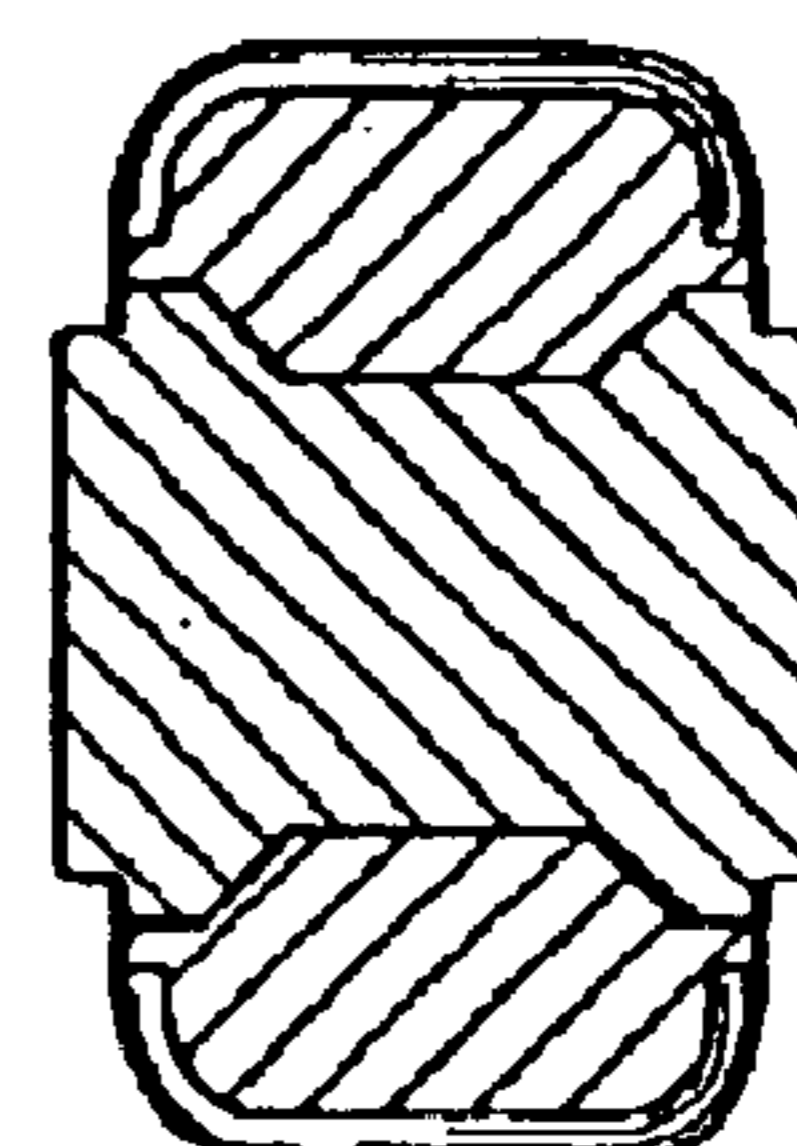

*FIG. 10*

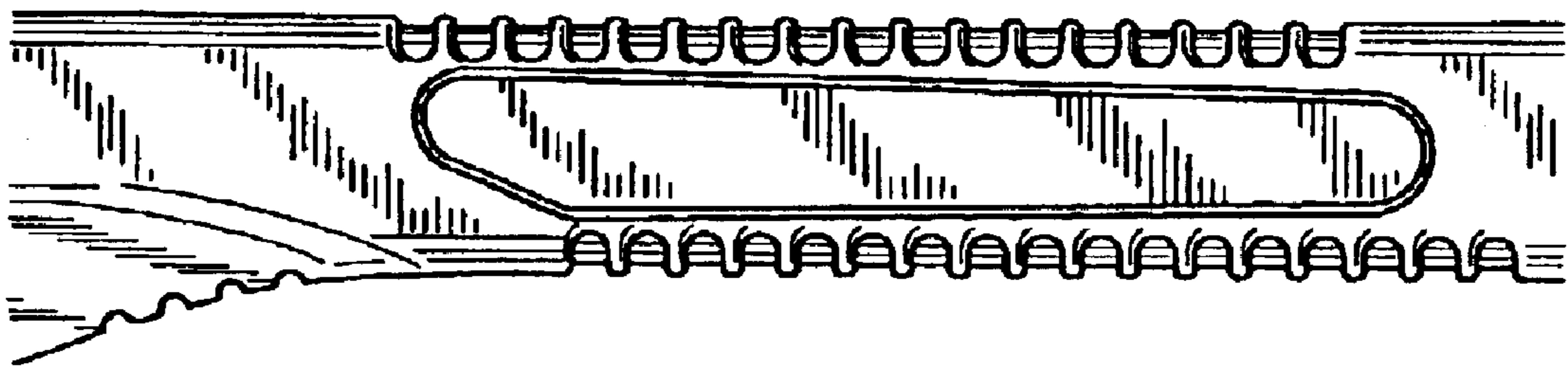

*FIG. 11*

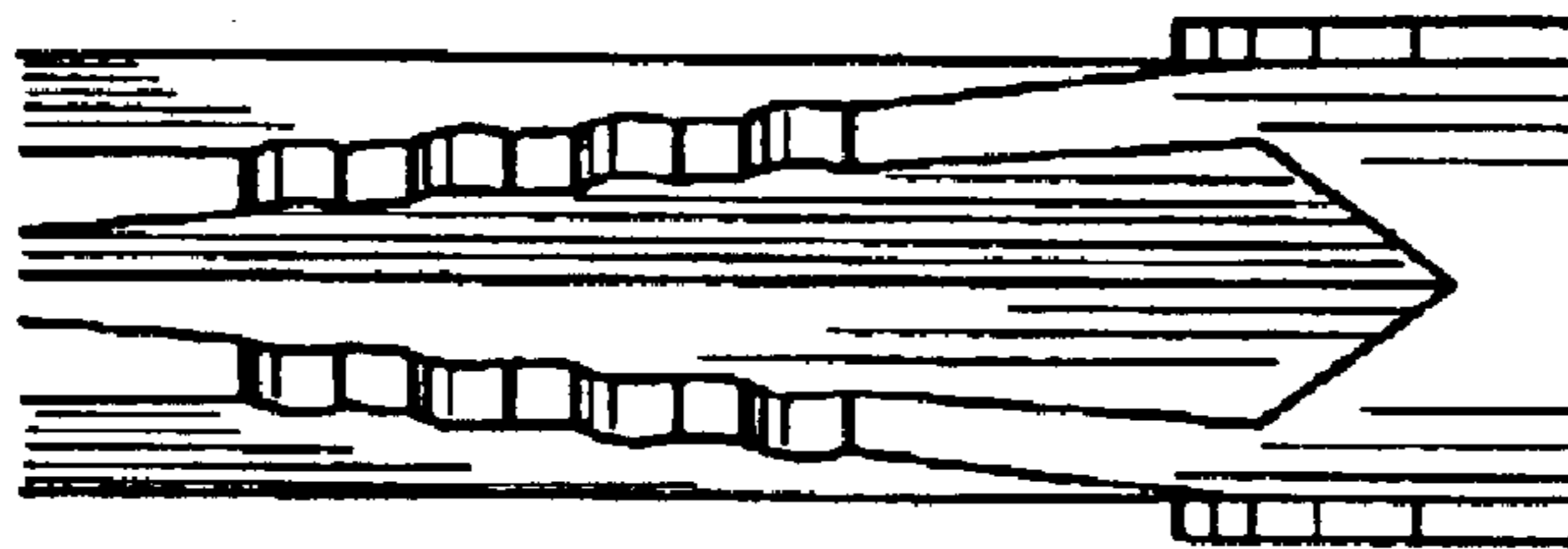

*FIG.12*

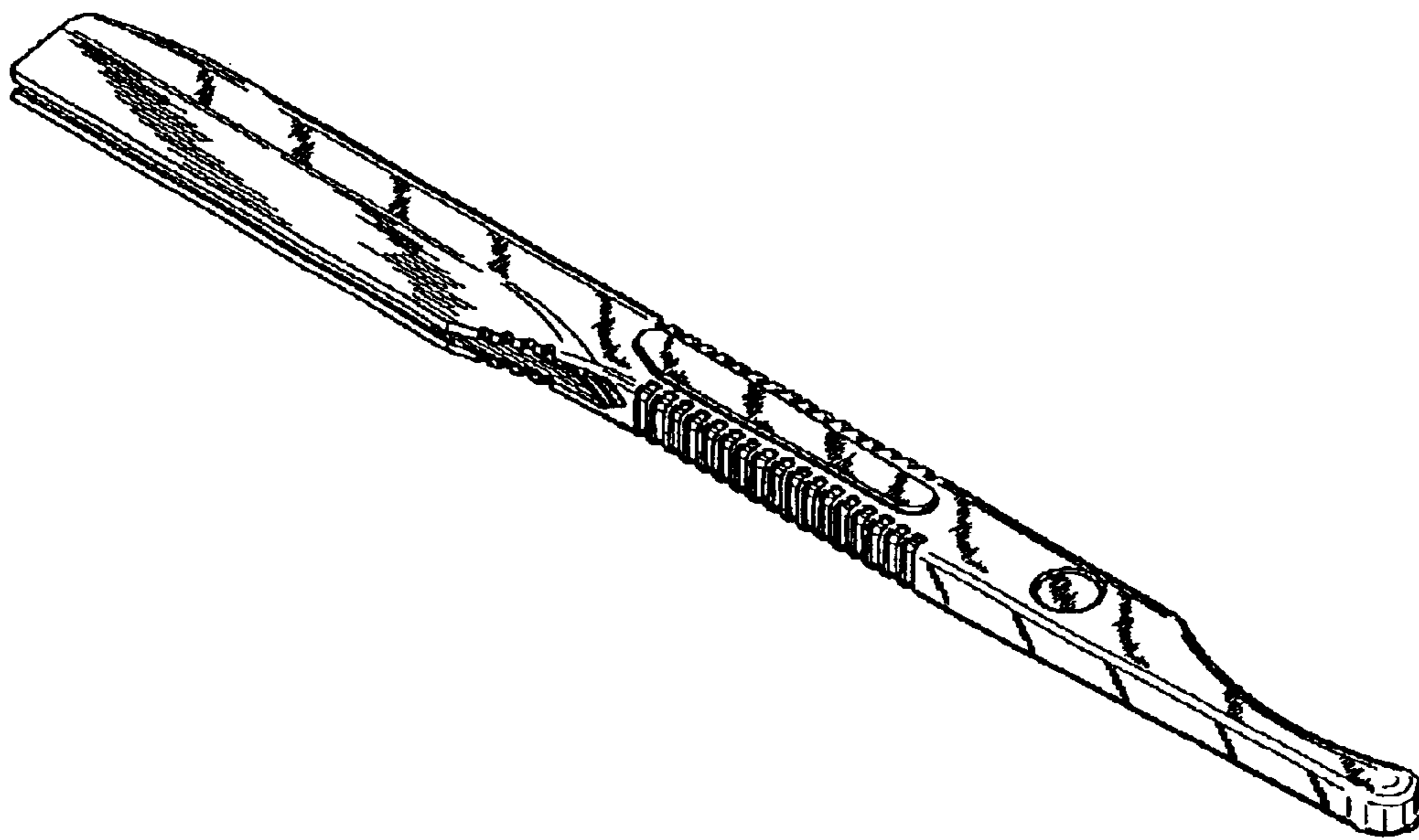

*FIG.13*

