



US00D501275S

(12) **United States Design Patent**  
**Habibi**

(10) **Patent No.:** **US D501,275 S**  
(45) **Date of Patent:** **\*\* Jan. 25, 2005**

(54) **TOOTHED HEATED HAIR STYLING DEVICE**

(75) Inventor: **Masood Habibi**, P.O. Box 71104, Los Angeles, CA (US) 90071

(73) Assignee: **Masood Habibi**, Beverly Hills, CA (US)

(\*\*) Term: **14 Years**

(21) Appl. No.: **29/177,850**

(22) Filed: **Mar. 14, 2003**

(51) **LOC (7) Cl.** ..... **28-03**

(52) **U.S. Cl.** ..... **D28/35**

(58) **Field of Search** ..... D28/35, 37, 38; 132/118, 269, 223-229; 219/222, 225, 226

(56) **References Cited**

**U.S. PATENT DOCUMENTS**

190,960 A 5/1877 Davis  
1,465,838 A 8/1923 Caneavri

(List continued on next page.)

**FOREIGN PATENT DOCUMENTS**

JP 58-92311 1/1983 ..... A45D/1/06  
JP 09191920 7/1997 ..... A45D/1/18

*Primary Examiner*—Jennifer Rivard

(74) *Attorney, Agent, or Firm*—Thelen Reid & Priest LLP; Hal Bohner

(57) **CLAIM**

The ornamental design for a toothed heated hair styling device, as shown and described.

**DESCRIPTION**

The design is embodied in a heated hair styling device used for styling hair.

FIG. 1 is a front elevation view of a toothed heated hair styling device in accordance with the present invention when the device is in a closed position.

FIG. 2 is a rear elevation view of the device of FIG. 1.

FIG. 3 is a top plan view of the device of FIG. 1.

FIG. 4 is a bottom view of the device of FIG. 1.

FIG. 5 is an elevation view of the left end of the device of FIG. 1.

FIG. 6 is an elevation view of the right end of the device of FIG. 1 showing a power cord and a temperature adjustment knob.

FIG. 7 is a view of the front of the device of FIG. 1 when the device is in an open position.

FIG. 8 is an isometric view of a portion of the device of FIG. 1 in the open position, showing the plate with pins.

FIG. 9 is an isometric view of a portion of the device of FIG. 1 in the open position, showing the plate with holes.

FIG. 10 is an isometric view of a portion of the device of FIG. 1 in a partially disassembled configuration with the water reservoir removed and uncapped.

FIG. 11 is an isometric view of the device of FIG. 1 in the open position, taken from the left end of the device and showing the plate with pins.

FIG. 12 is a rear elevation view of the device of FIG. 1.

FIG. 13 is a view of the plate with holes of the device of FIG. 1; and,

FIG. 14 is a view of the plate with pins of the device of FIG. 1.

The plates in FIGS. 13 and 14 are disclosed separately for convenience of illustration.

**1 Claim, 9 Drawing Sheets**

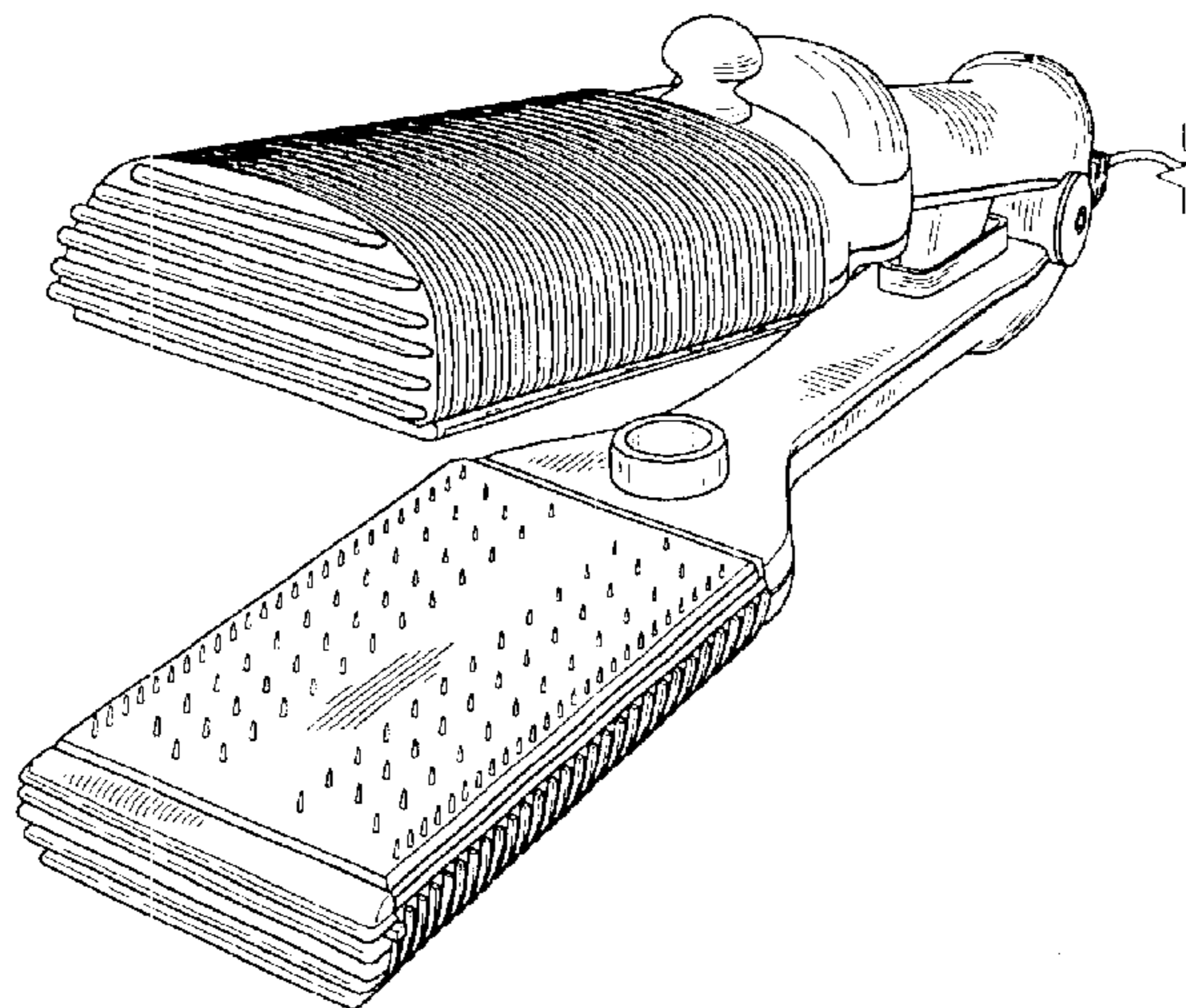

# US D501,275 S

Page 2

## U.S. PATENT DOCUMENTS

1,588,241 A	6/1926	Leland		5,232,137 A	8/1993	Devine	
1,731,522 A	10/1929	Carlson		5,263,501 A	11/1993	Maznik	
1,852,269 A	4/1932	Siers		5,294,777 A	3/1994	Denhup	219/225
1,858,851 A	5/1932	Buchanan		5,400,809 A	3/1995	Adams	132/118
1,892,107 A	12/1932	Jancke et al.		5,799,671 A	9/1998	Takimae	132/225
1,894,431 A	7/1933	Vaghelatos		D411,333 S	* 6/1999	Smal	D28/35
1,926,987 A	9/1933	Durham et al.		5,934,293 A	8/1999	Kaizuka	132/225
1,957,049 A	5/1934	Lakenbach		6,029,677 A	2/2000	Nanba et al.	132/225
2,244,068 A	6/1941	Kay		6,119,702 A	9/2000	Habibi	132/224
2,720,207 A	10/1955	Burtnett		6,191,387 B1	* 2/2001	Smal	219/225
2,818,869 A	1/1958	Rose		D440,710 S	* 4/2001	Kaizuka	D28/35
3,108,603 A	10/1963	Mobberley		6,223,753 B1	* 5/2001	Lo	132/224
4,623,779 A	11/1986	Raab	219/222	6,477,732 B1	11/2002	Cline et al.	15/185
4,739,151 A	4/1988	Smal		D479,626 S	* 9/2003	Colombo	D28/35
4,917,078 A	4/1990	Zaborowski	126/409	D482,491 S	* 11/2003	Maesawa et al.	D28/35
5,212,366 A	5/1993	McDougall	219/222				

\* cited by examiner

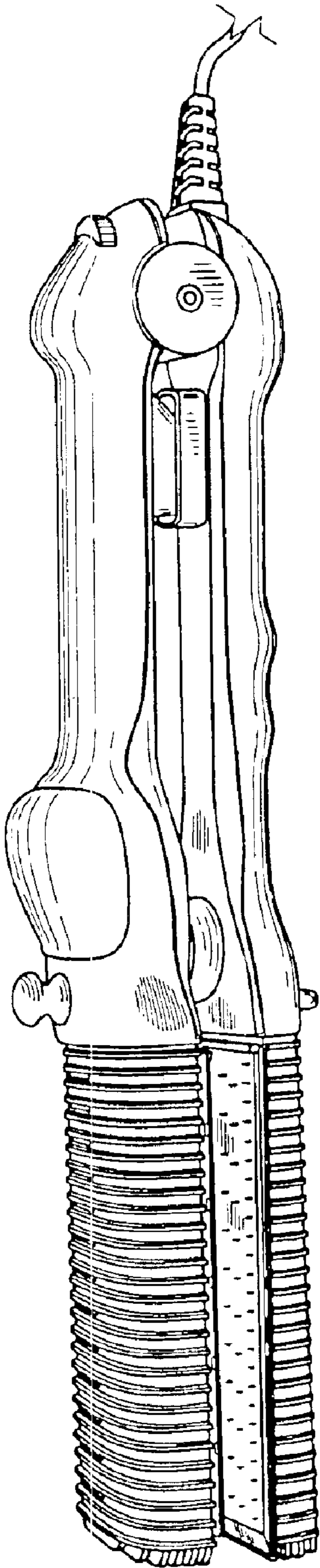

FIG. 1

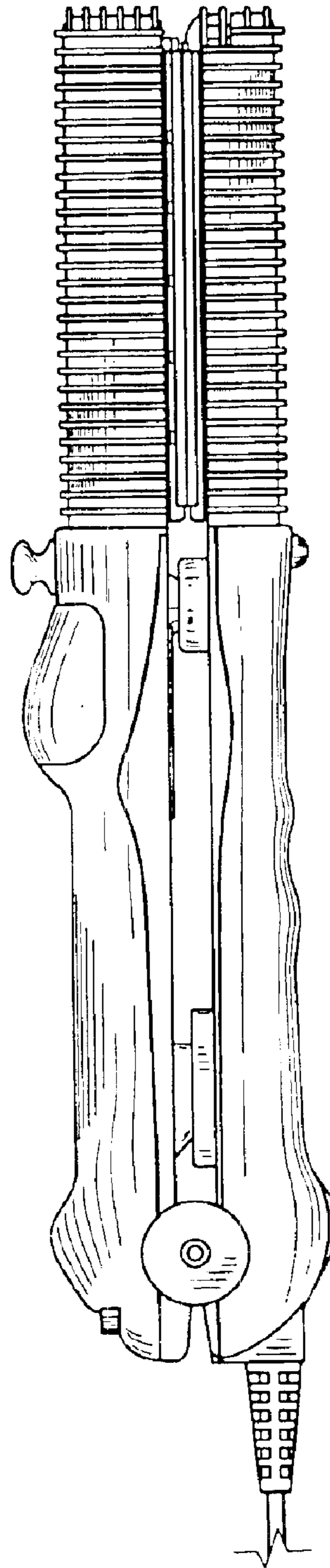

FIG. 2

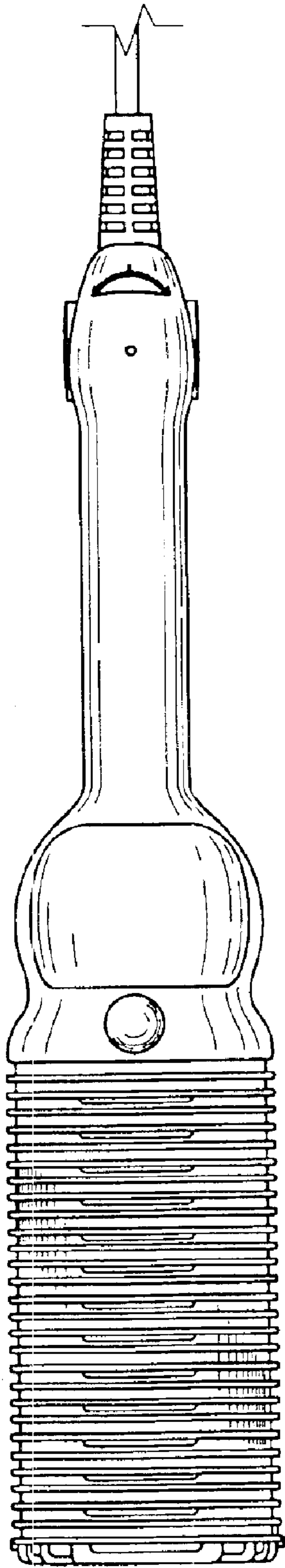

FIG. 3

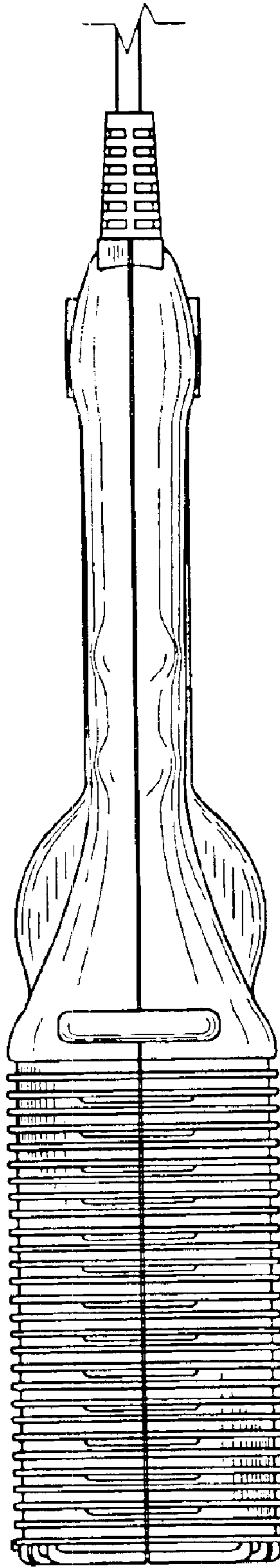

FIG. 4

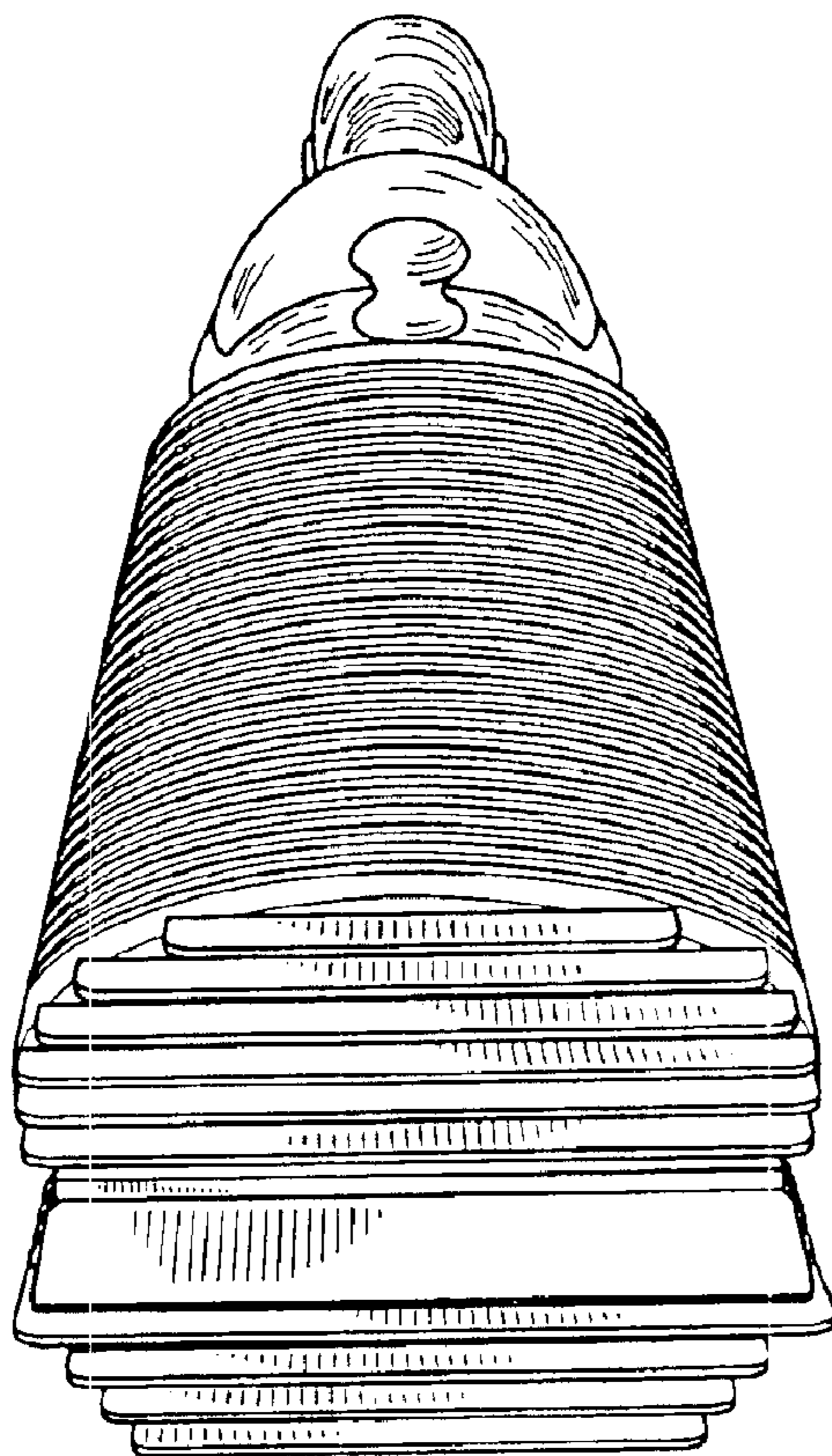

FIG. 5

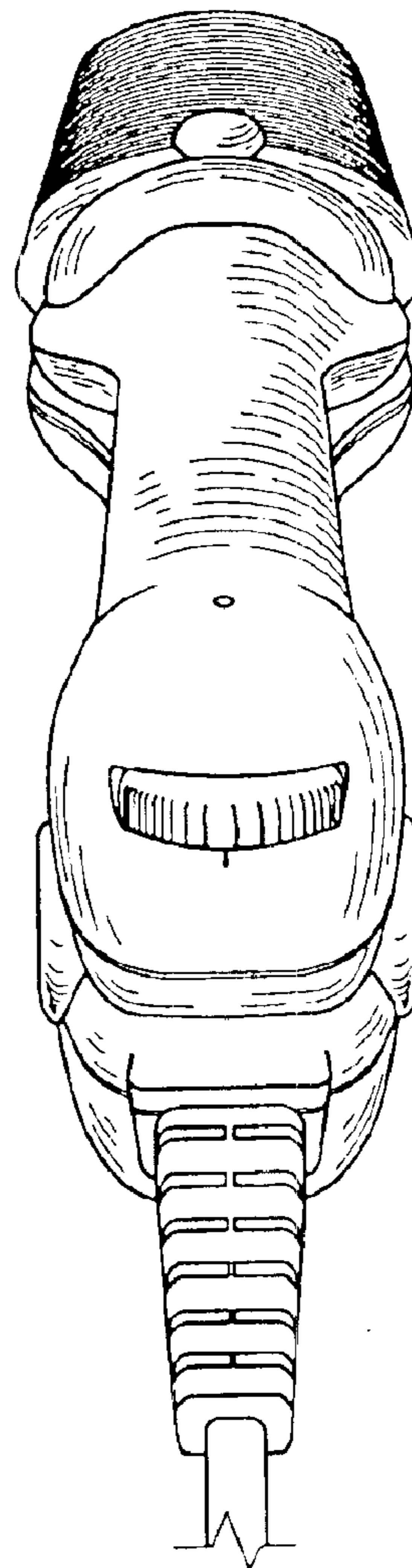

FIG. 6

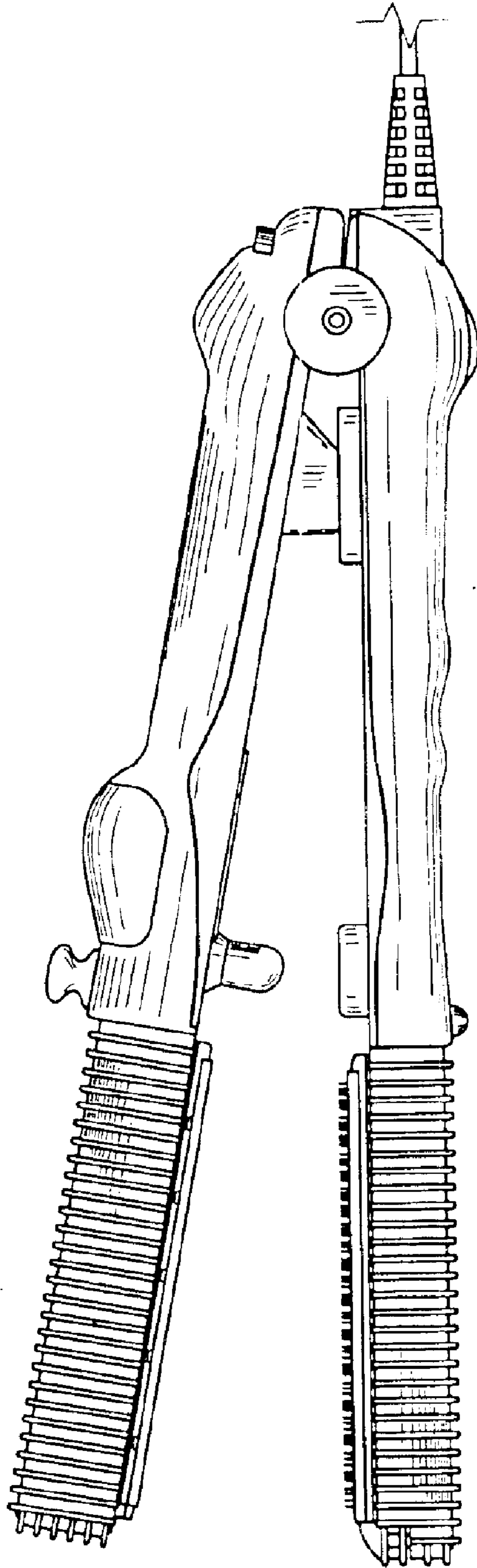

FIG. 7

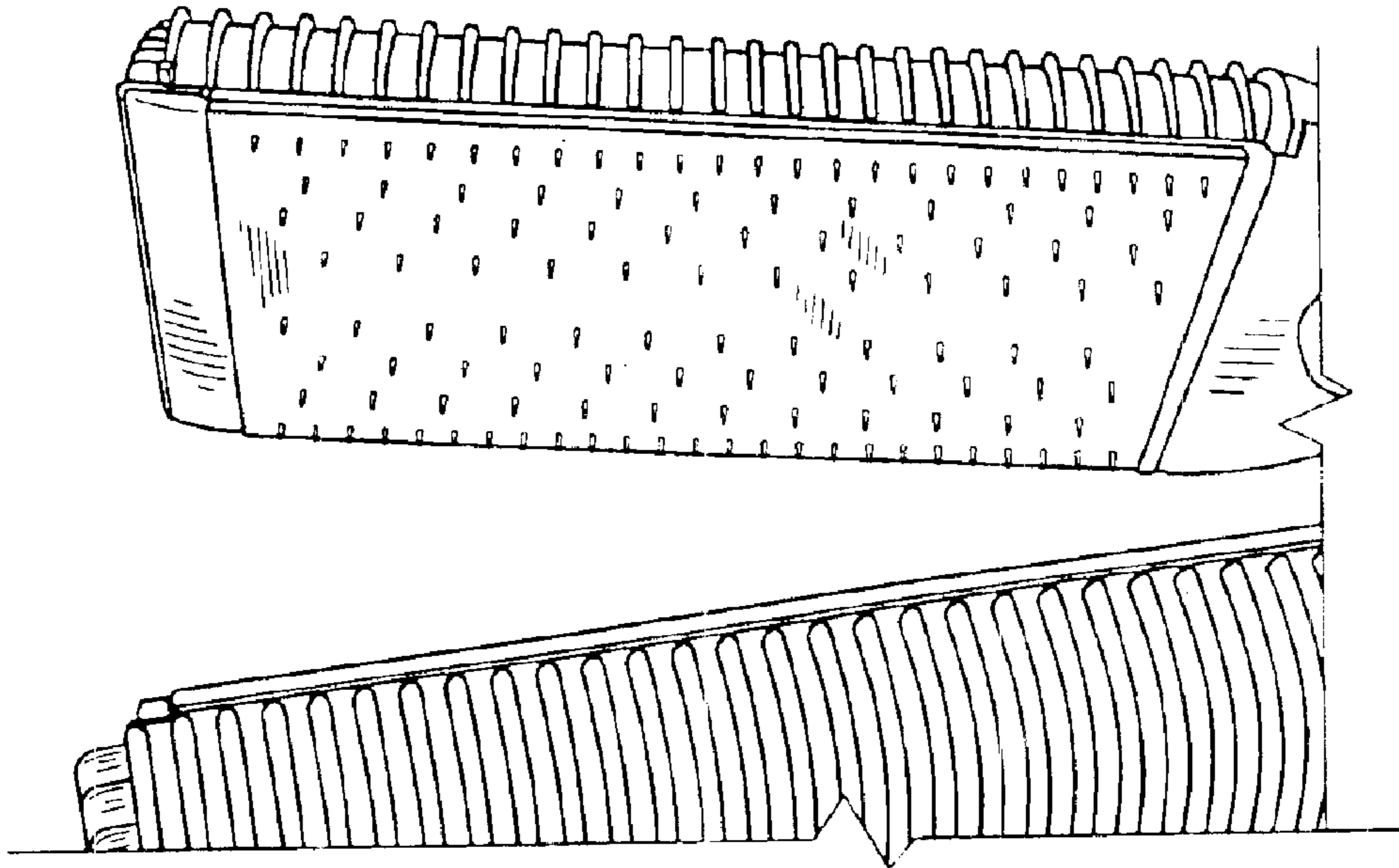

FIG. 8

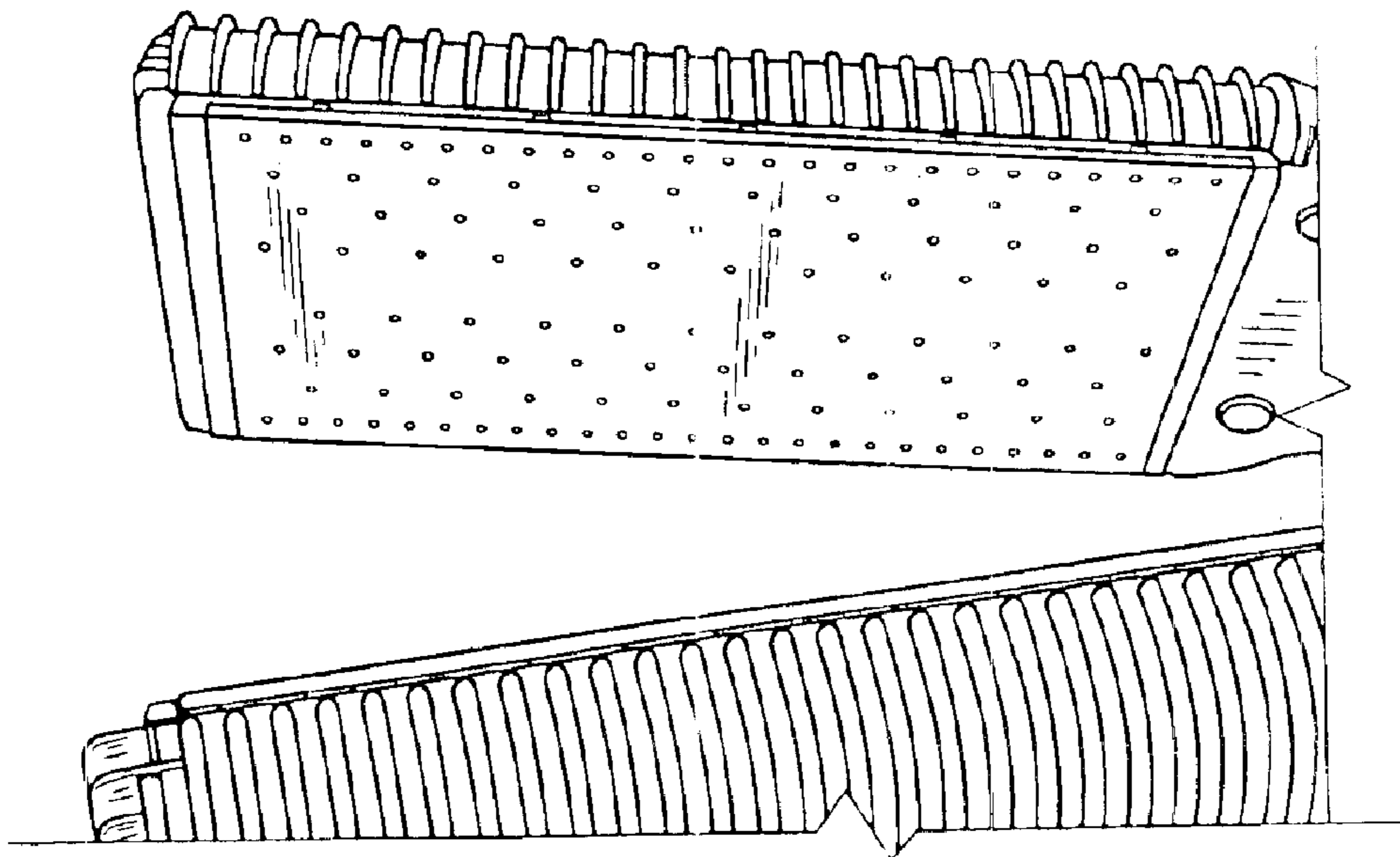

FIG. 9

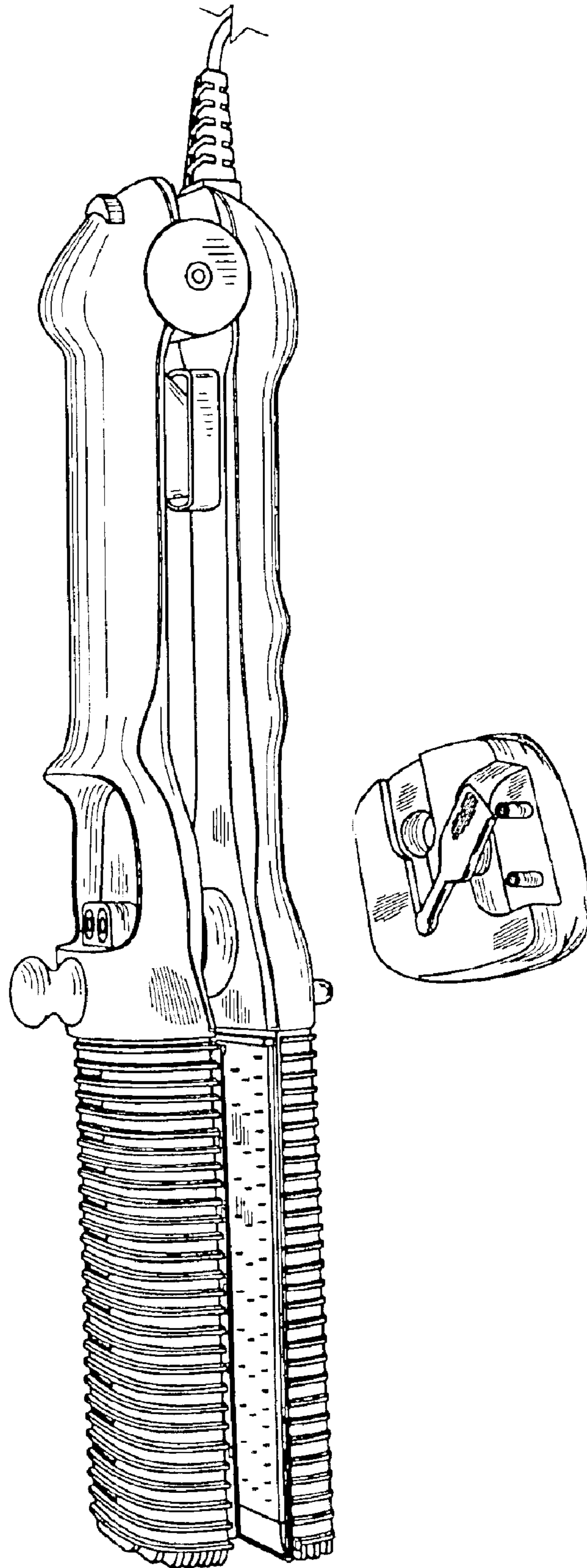

FIG. 10



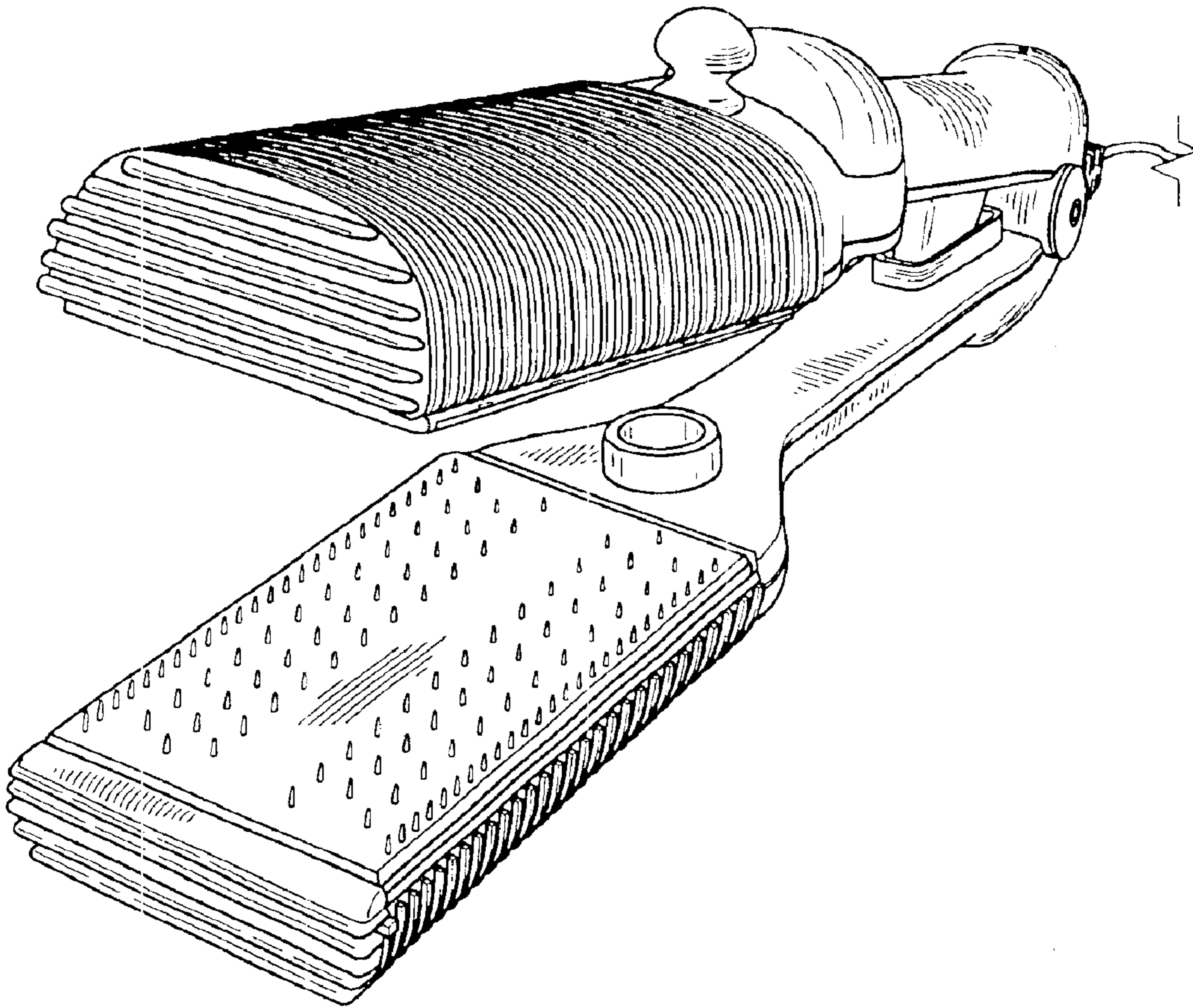

FIG. 11

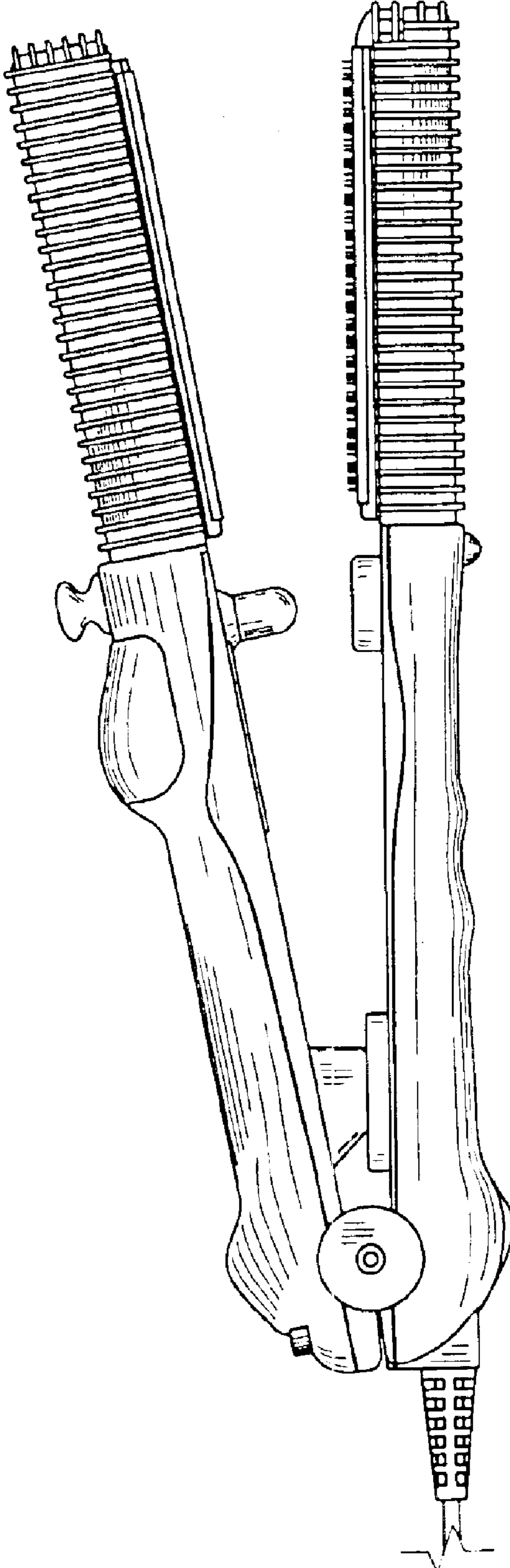

FIG. 12

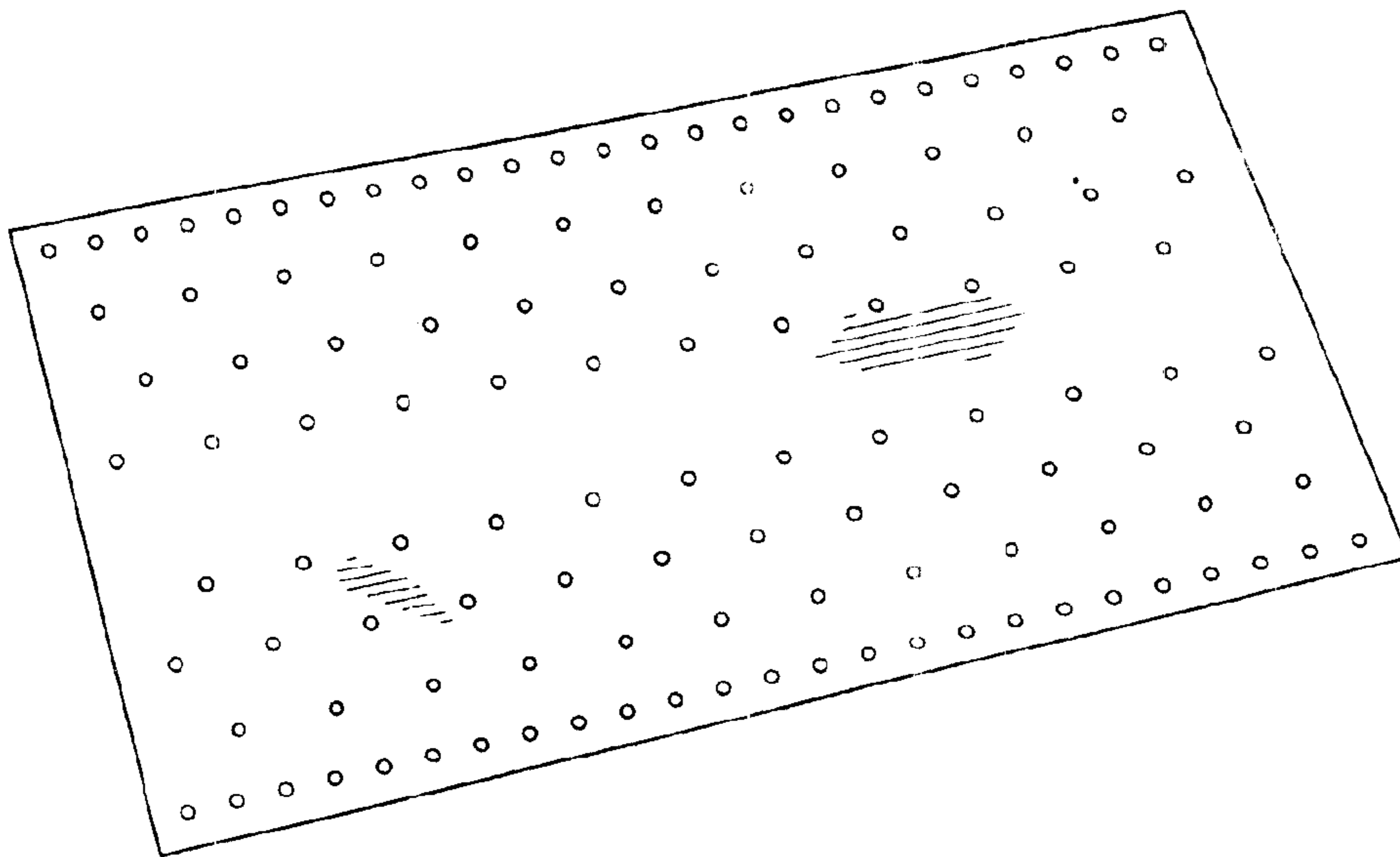

FIG. 13

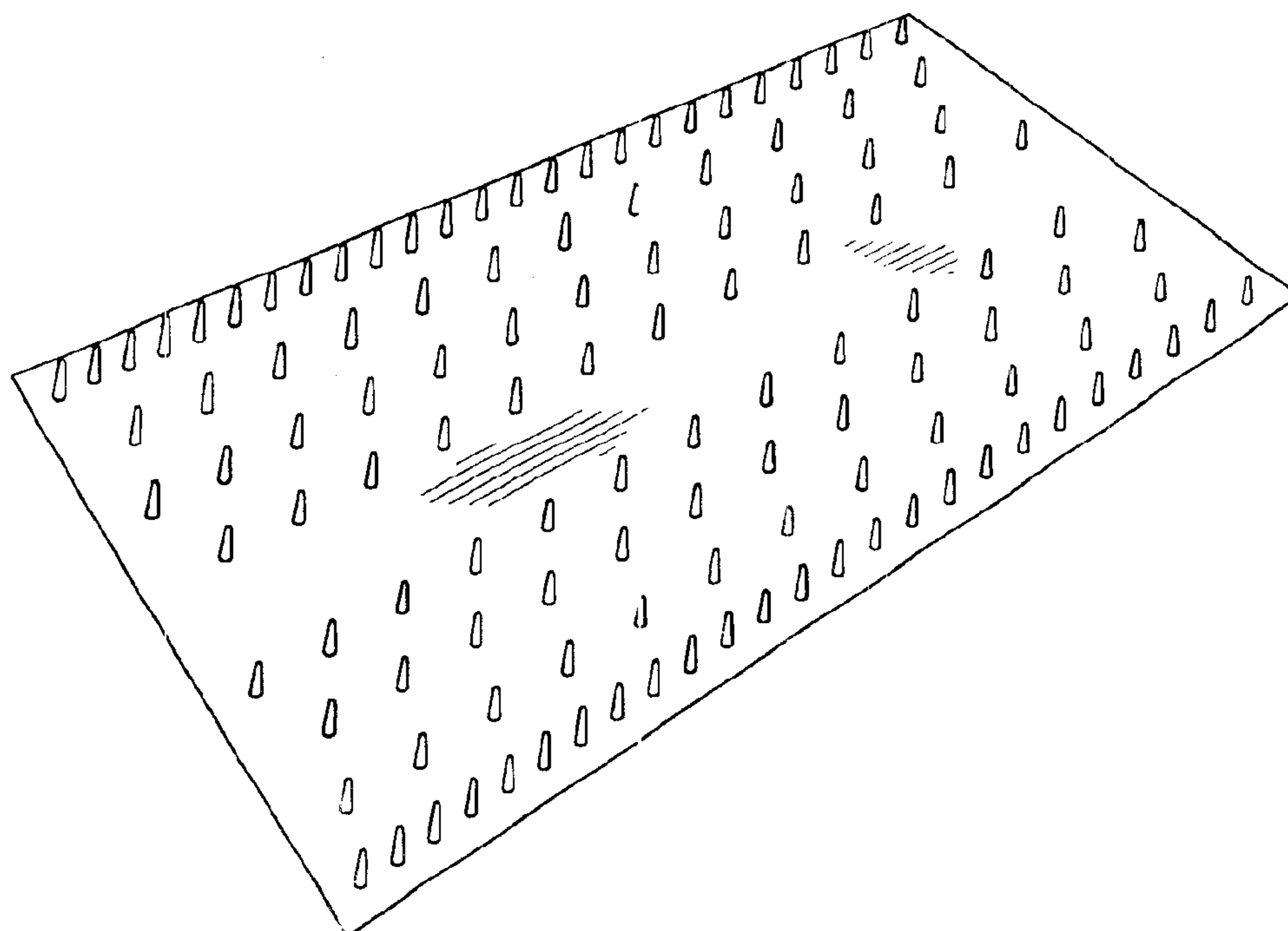

FIG. 14