

US00D501054S

(12) **United States Design Patent**  
**Galli**

(10) **Patent No.:** **US D501,054 S**  
(45) **Date of Patent:** **\*\* Jan. 18, 2005**

- (54) **FLASHLIGHT**
- (76) **Inventor:** **Robert D. Galli**, 8176 Horseshoe Bend La., Las Vegas, NV (US) 89113
- (\*\*) **Term:** **14 Years**
- (21) **Appl. No.:** **29/202,061**
- (22) **Filed:** **Mar. 25, 2004**
- (51) **LOC (7) Cl.** ..... **26-02**
- (52) **U.S. Cl.** ..... **D26/37**
- (58) **Field of Search** ..... D26/37-50; 362/157, 362/158, 171-174, 183-208

D476,103 S 6/2003 Galli ..... D26/37  
 D481,482 S \* 10/2003 Mah ..... D26/37

\* cited by examiner

*Primary Examiner*—Marcus A. Jackson  
 (74) *Attorney, Agent, or Firm*—Barlow, Josephs & Holmes, Ltd.

(57) **CLAIM**

The ornamental design for a flashlight, as shown and described.

**DESCRIPTION**

FIG. 1 is a perspective view of a flashlight, showing my new design;  
 FIG. 2 is a top plan view thereof;  
 FIG. 3 is a bottom view thereof;  
 FIG. 4 is a front view thereof;  
 FIG. 5 is a left side view thereof;  
 FIG. 6 is a rear view thereof; and,  
 FIG. 7 is a right side view thereof.

**1 Claim, 7 Drawing Sheets**

(56) **References Cited**  
 U.S. PATENT DOCUMENTS

D434,164 S	11/2000	Galli	.....	D26/49
D455,510 S	4/2002	Galli	.....	D26/37
D455,513 S	4/2002	Galli	.....	D26/49
D463,593 S	9/2002	Galli	.....	D26/49
D468,464 S	1/2003	Galli	.....	D26/37
D468,851 S	1/2003	Galli	.....	D26/37

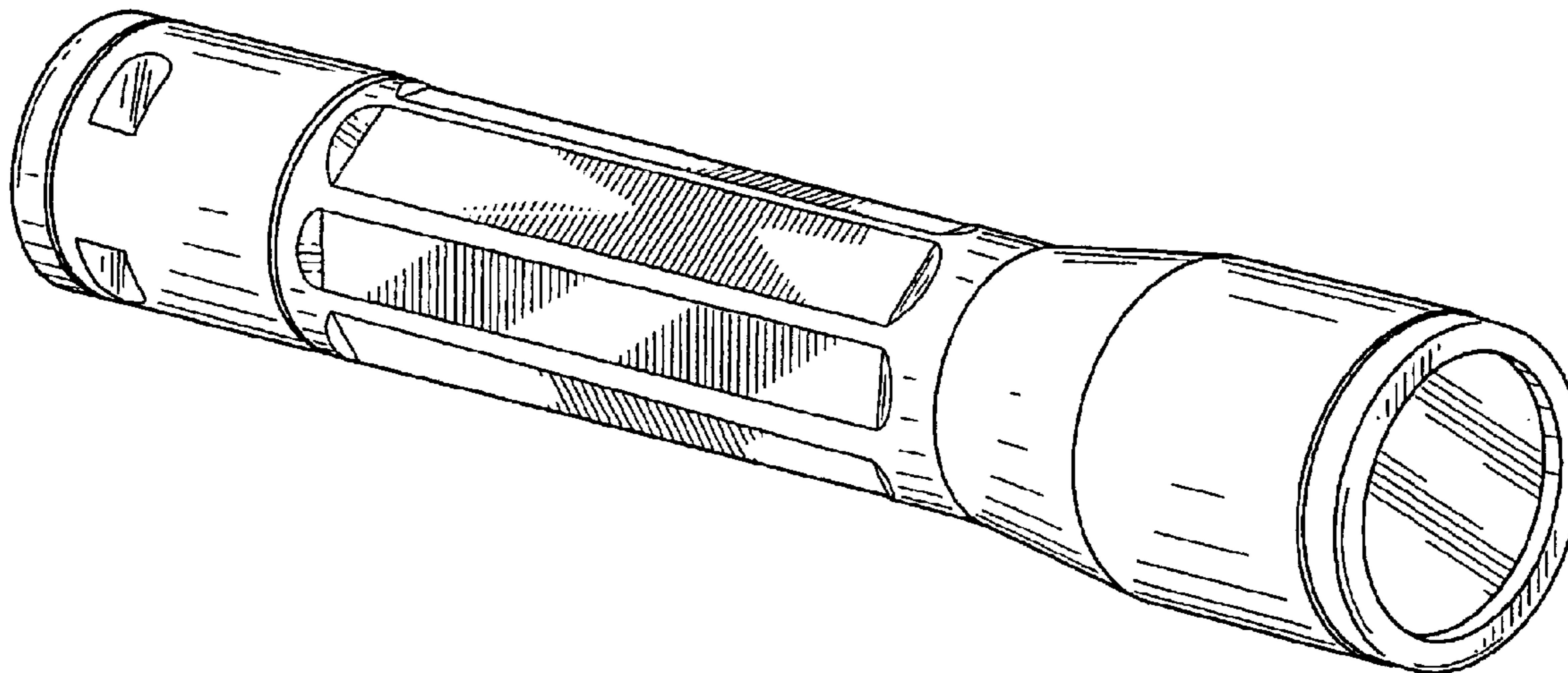

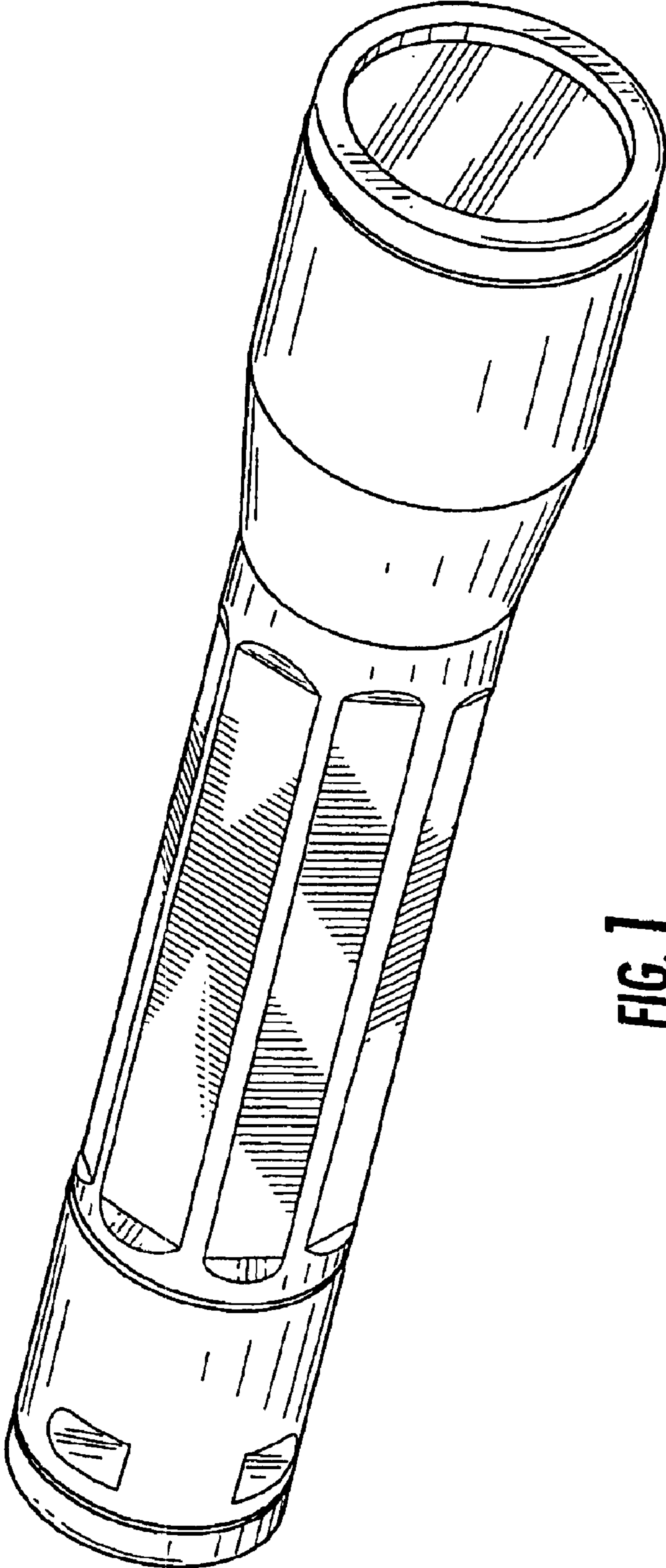

**FIG. 1**

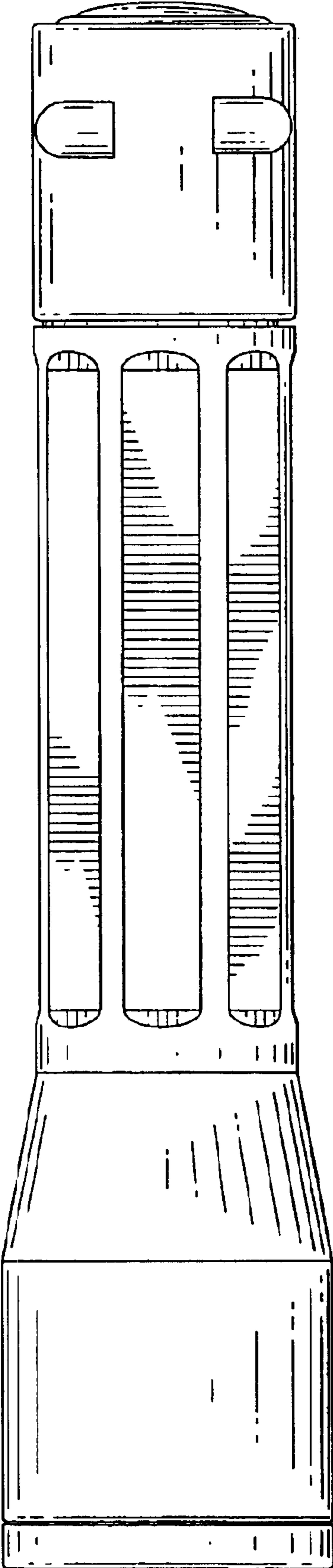

FIG. 2

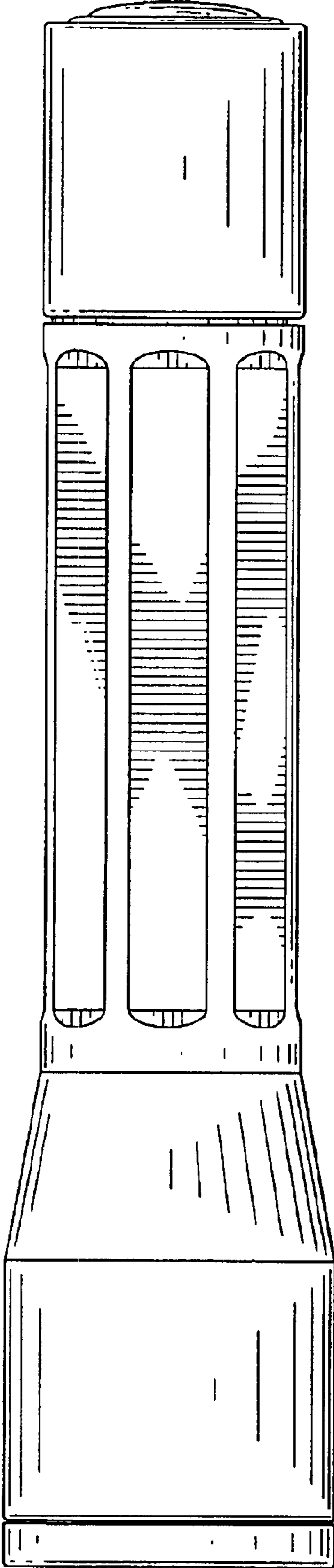
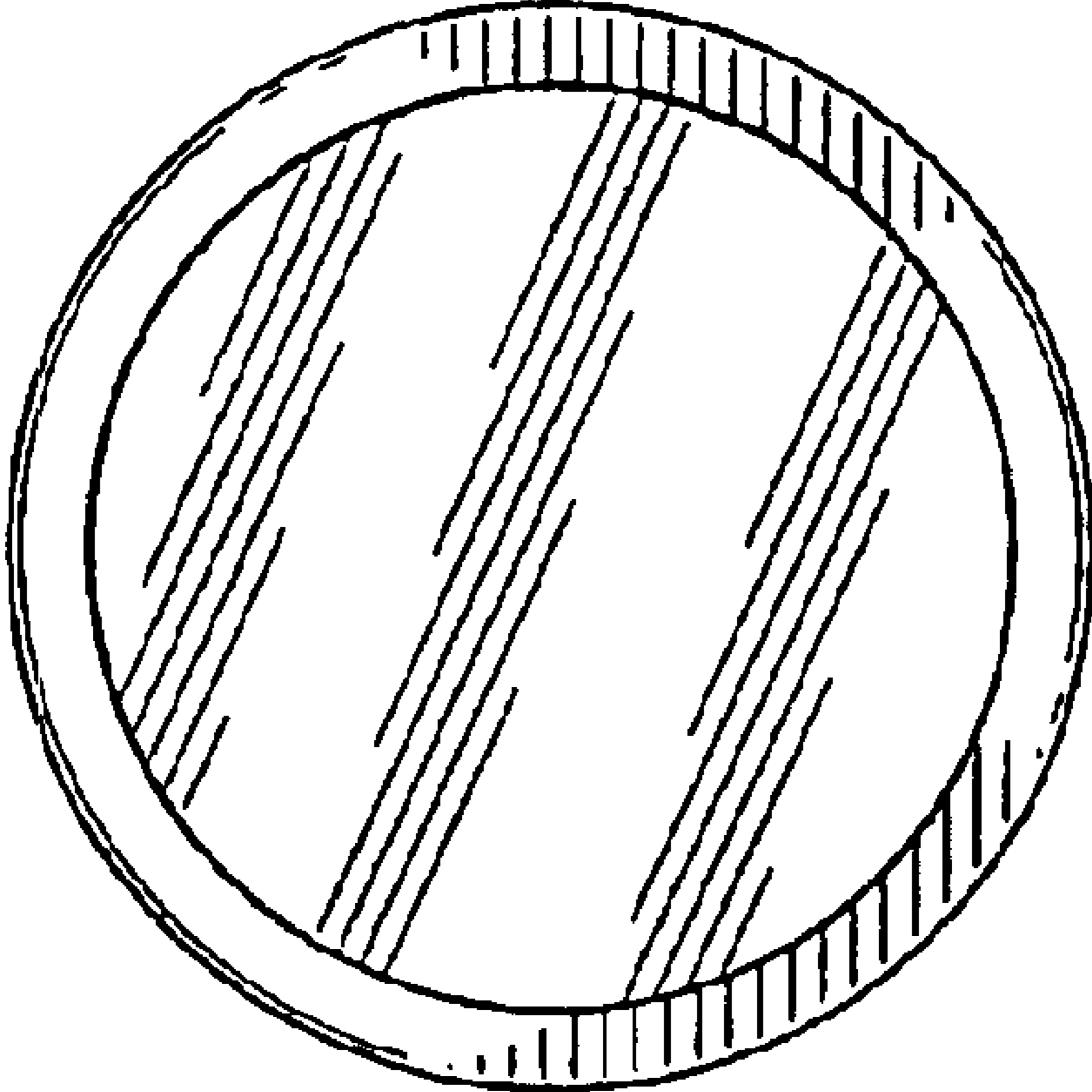

FIG. 3



**FIG. 4**

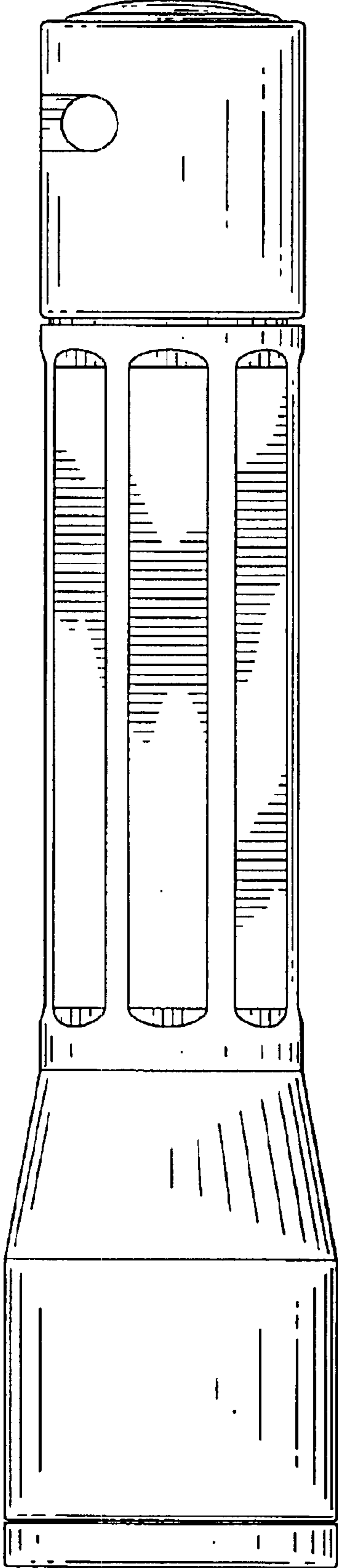
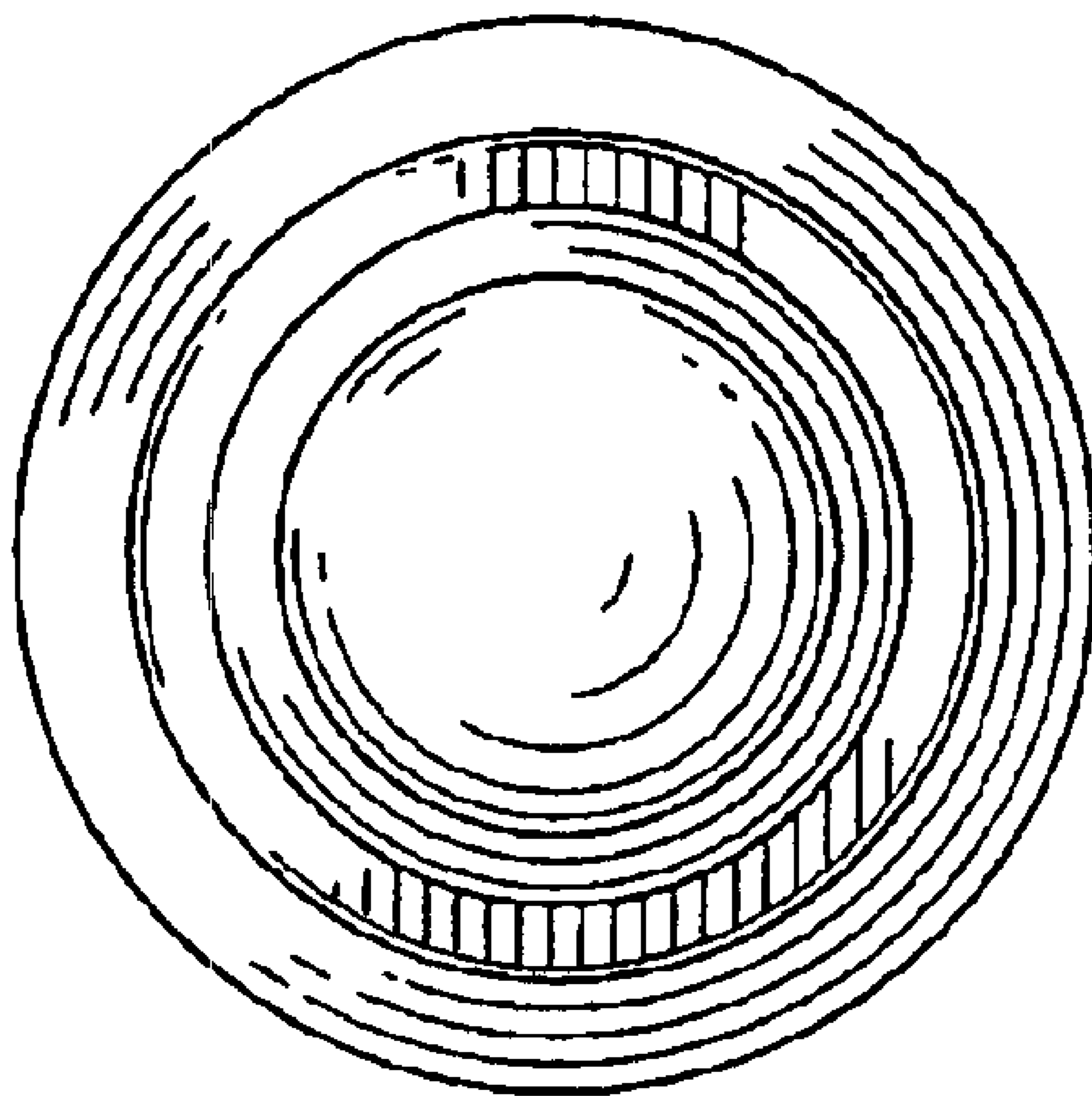

FIG. 5



**FIG. 6**



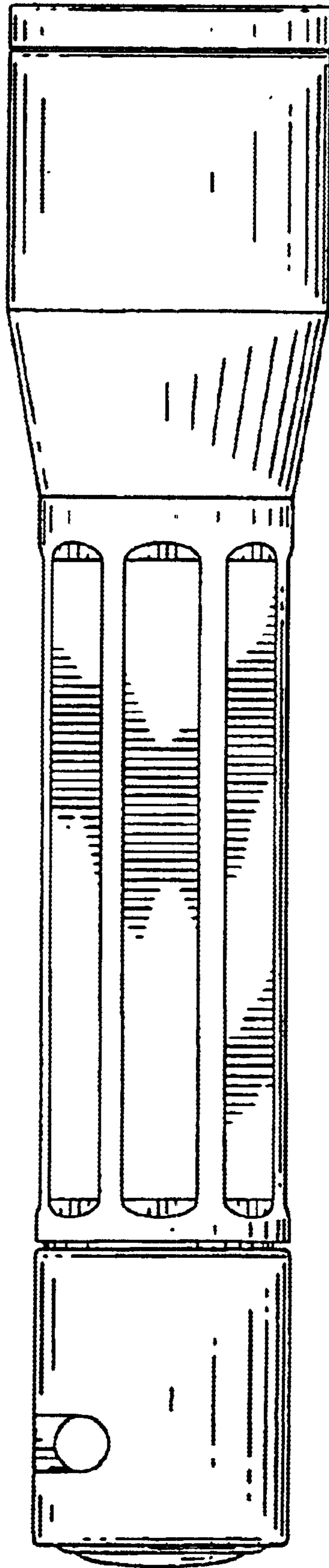

FIG. 7