

US00D501024S

(12) **United States Design Patent**  
**Suzuki et al.**

(10) **Patent No.: US D501,024 S**  
(45) **Date of Patent: \*\* Jan. 18, 2005**

(54) **LASER PRINTER**

(75) Inventors: **Hiroko Suzuki**, Kanagawa (JP);  
**Osamu Miki**, Kanagawa (JP)

(73) Assignee: **Ricoh Company, Ltd.**, Tokyo (JP)

(\*\*) Term: **14 Years**

(21) Appl. No.: **29/187,498**

(22) Filed: **Aug. 4, 2003**

(30) **Foreign Application Priority Data**

Feb. 5, 2003 (JP) ..... 2003-002493

(51) **LOC (7) Cl. .... 14-02**

(52) **U.S. Cl. .... D18/55**

(58) **Field of Search** ..... D18/4.1, 19, 36-41,  
D18/50, 53-54, 54.1, 55; D14/420-425,  
462-470, 349; 400/613, 613.1-613.4, 690.1-690.4,  
691-694

(56) **References Cited**

**U.S. PATENT DOCUMENTS**

D378,300 S \* 3/1997 Ito ..... D18/55  
D386,519 S \* 11/1997 Meschter et al. .... D18/55  
D402,698 S \* 12/1998 Falk et al. .... D18/55  
D405,110 S \* 2/1999 Yamamoto et al. .... D18/54

D421,455 S \* 3/2000 Kobayashi et al. .... D18/54  
D432,564 S \* 10/2000 Miyazawa ..... D18/54  
D436,987 S \* 1/2001 Suzuki et al. .... D18/4.1  
D437,349 S \* 2/2001 Saito et al. .... D18/55  
D439,276 S \* 3/2001 Kemmochi et al. .... D18/55  
D455,172 S \* 4/2002 Falk et al. .... D18/55  
6,767,149 B2 \* 7/2004 Yoshihara ..... 400/692

\* cited by examiner

*Primary Examiner*—Cathy Anne MacCormac

(74) *Attorney, Agent, or Firm*—Dickstein Shapiro Morin &  
Oshinsky LLP

(57) **CLAIM**

The ornamental design for a laser printer, as shown and described.

**DESCRIPTION**

FIG. 1 is a front elevation of a laser printer according to the present invention;  
FIG. 2 is a rear elevation thereof;  
FIG. 3 is a top plan view thereof;  
FIG. 4 is a bottom plan view thereof;  
FIG. 5 is a right side elevation thereof;  
FIG. 6 is a left side elevation thereof; and,  
FIG. 7 is a top, front and right side perspective view thereof.

**1 Claim, 5 Drawing Sheets**

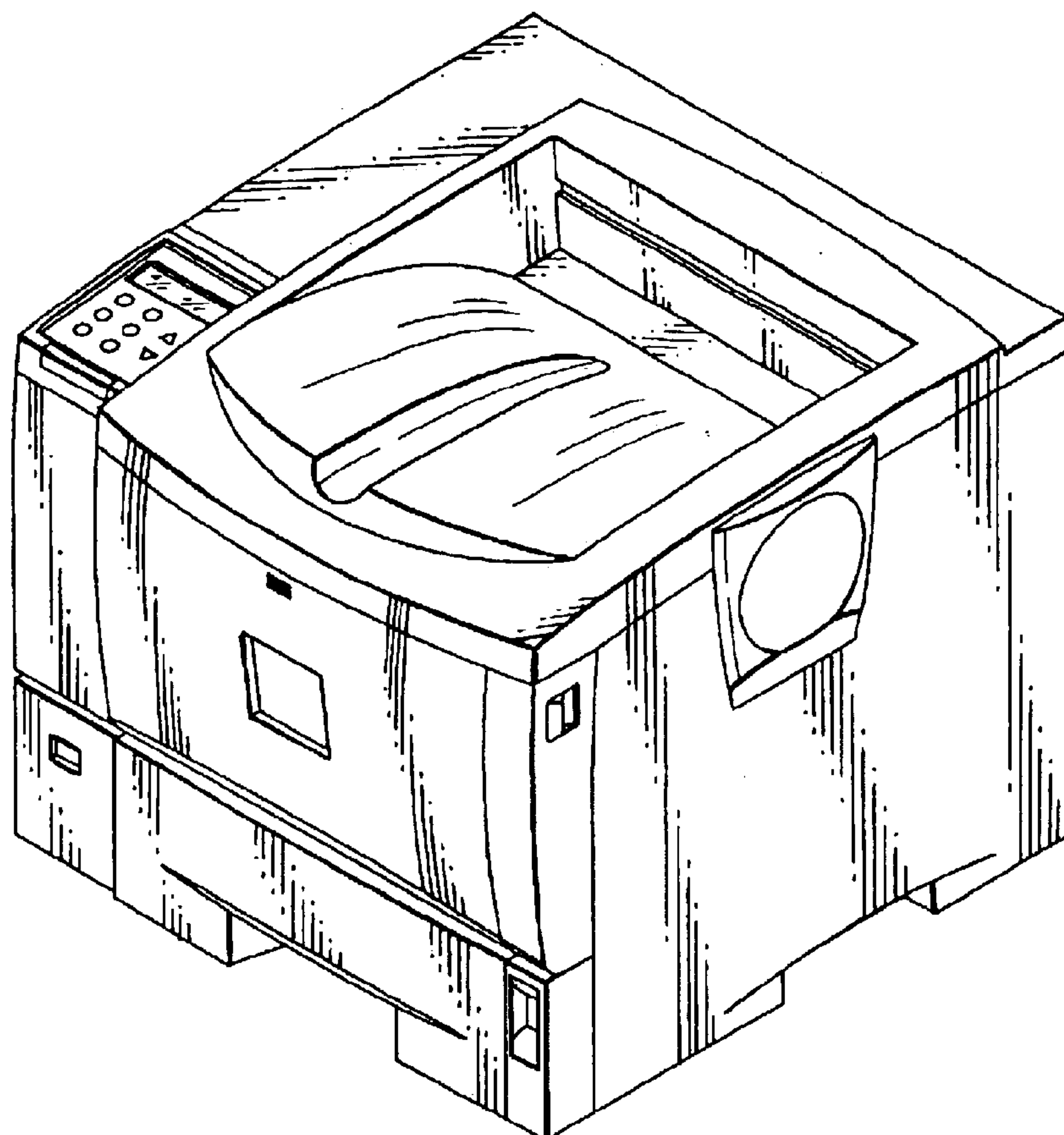

FIG. 1

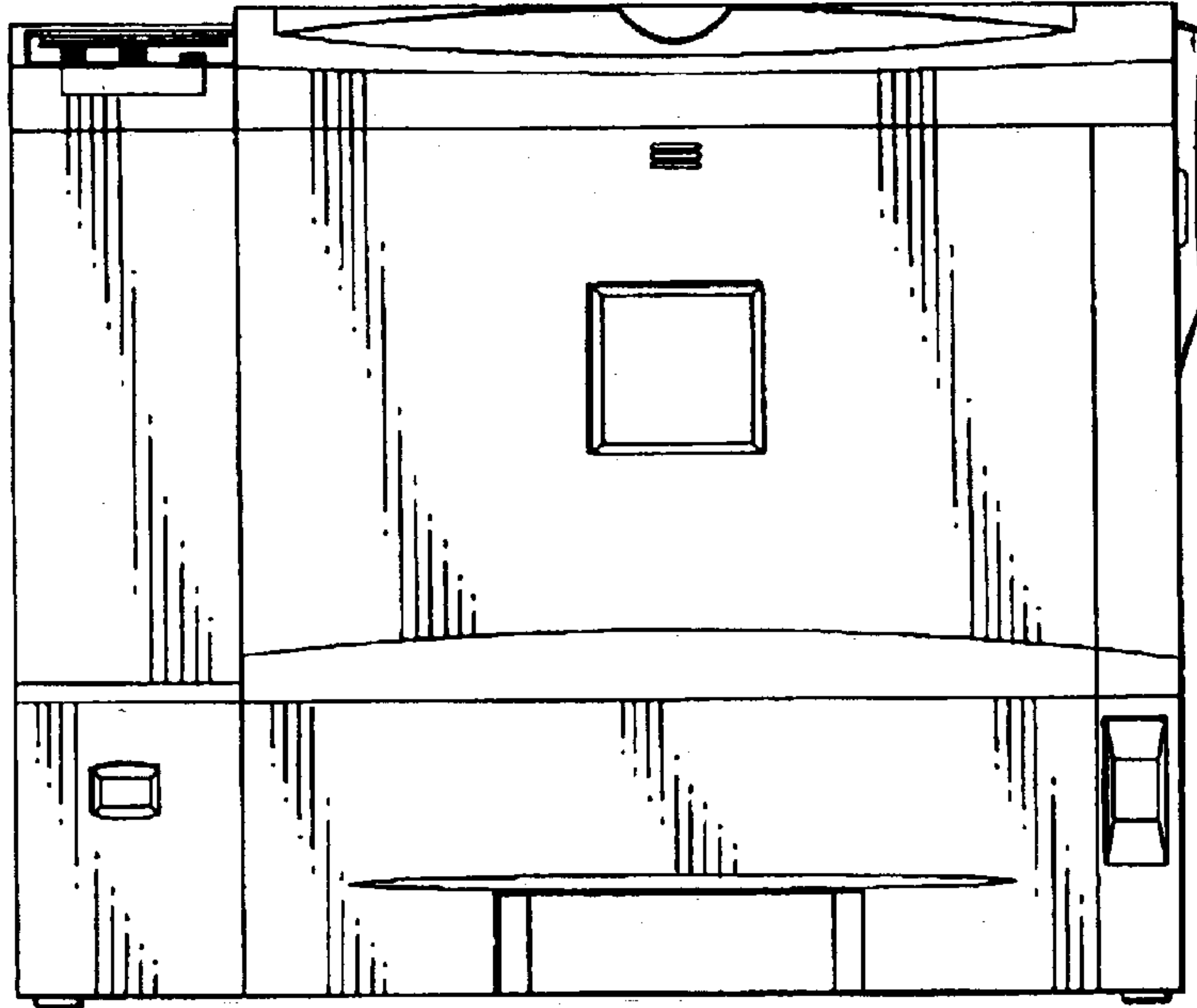

FIG. 2

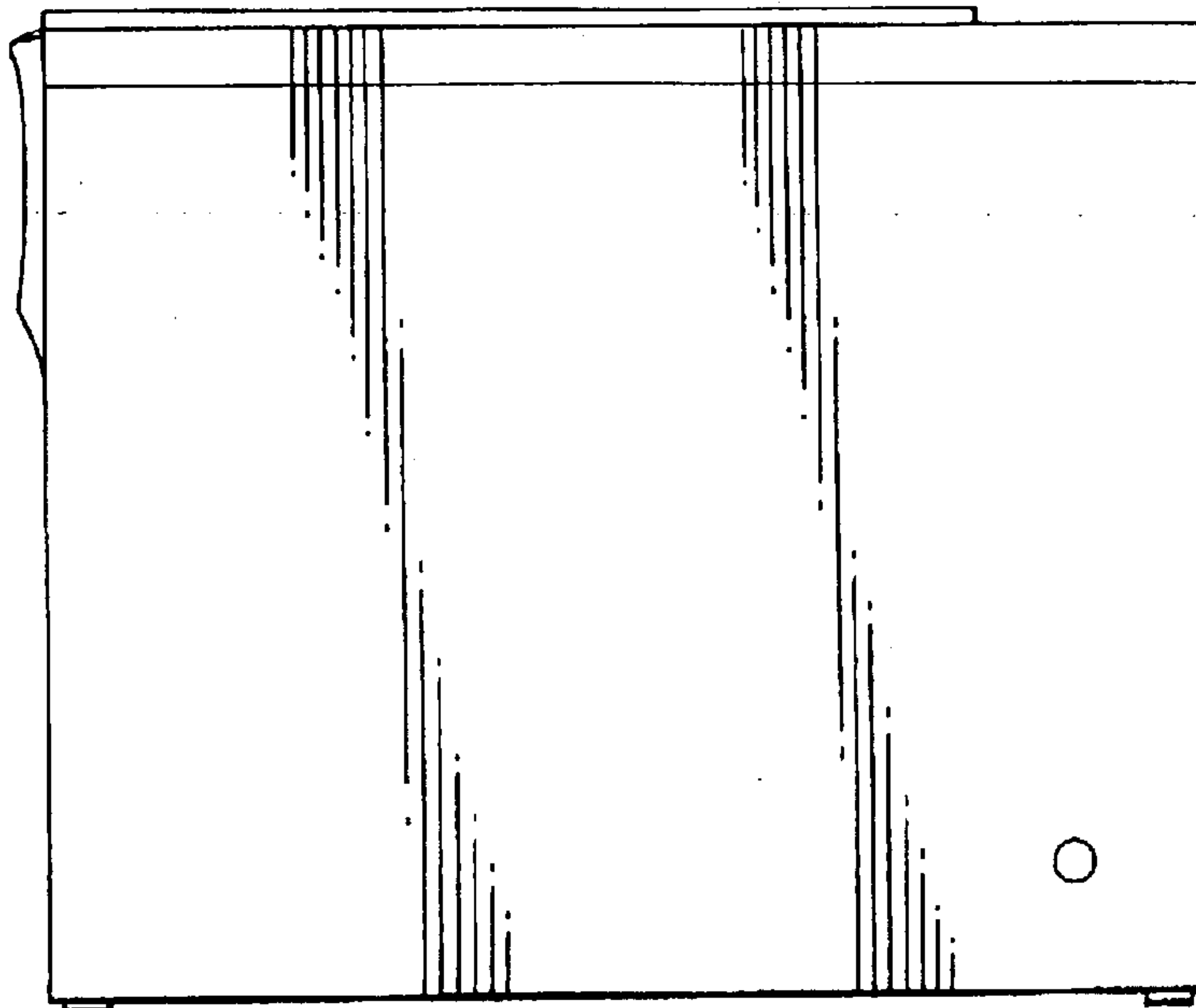

FIG. 3

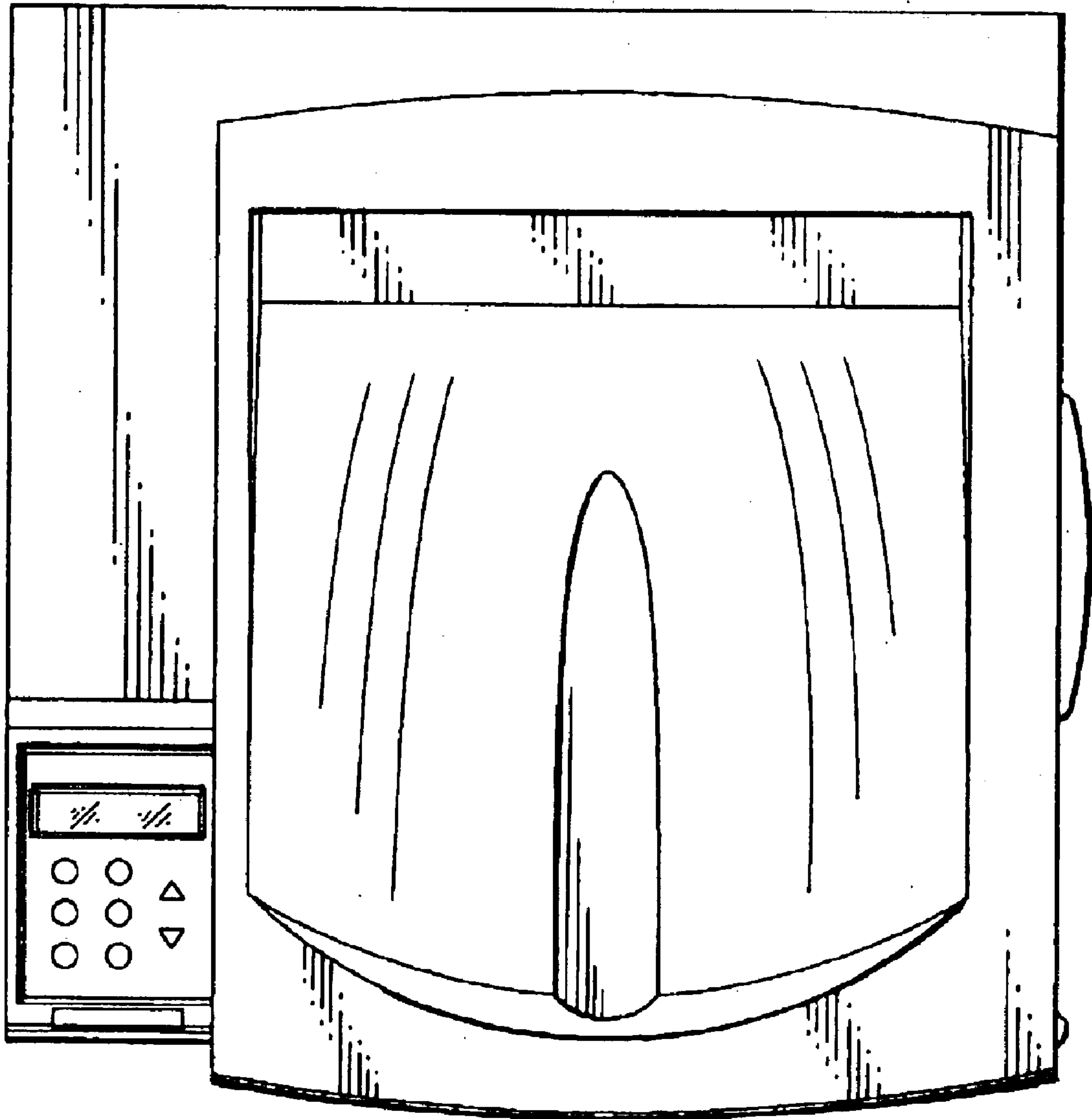

FIG. 4

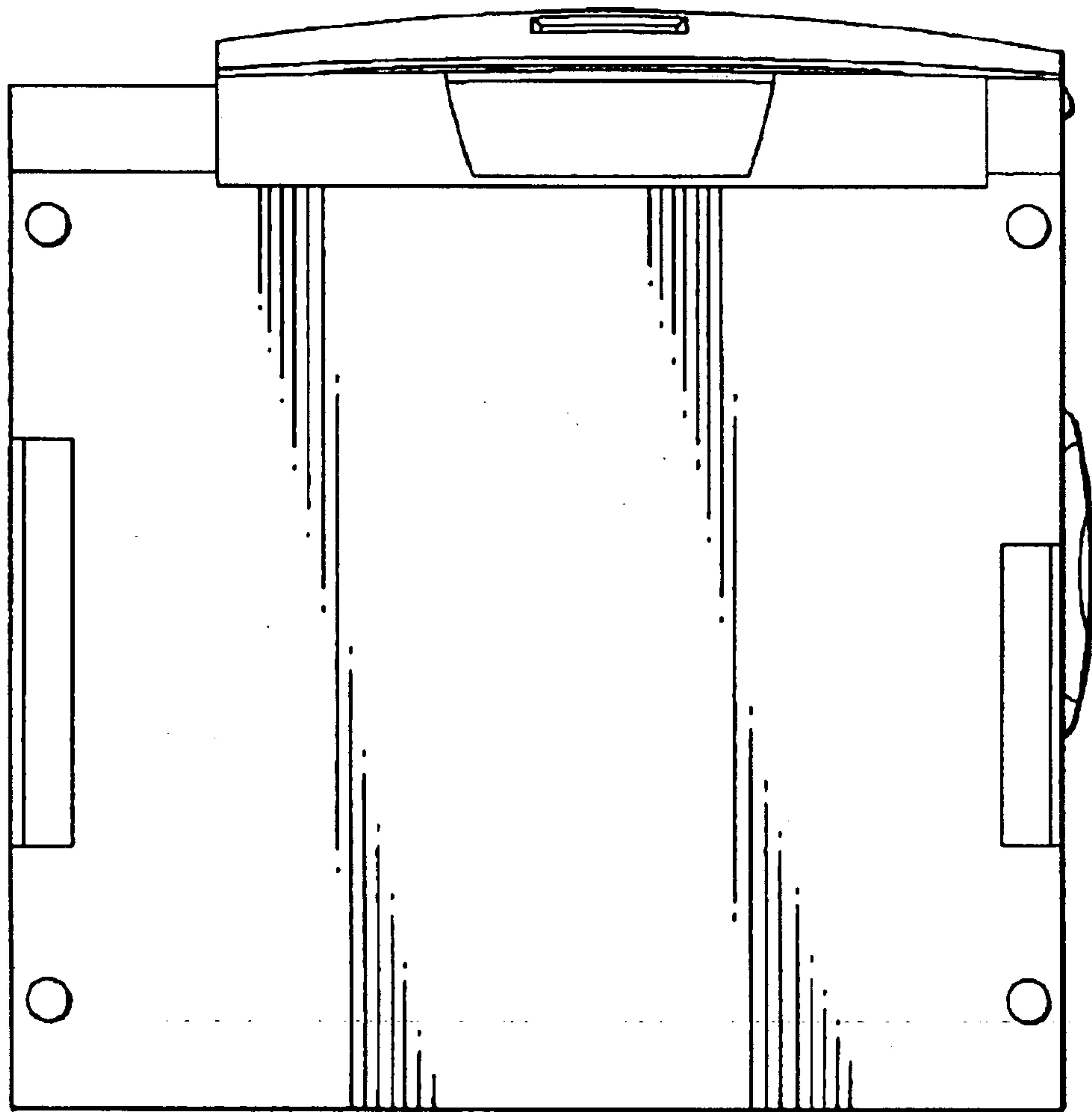

FIG. 5

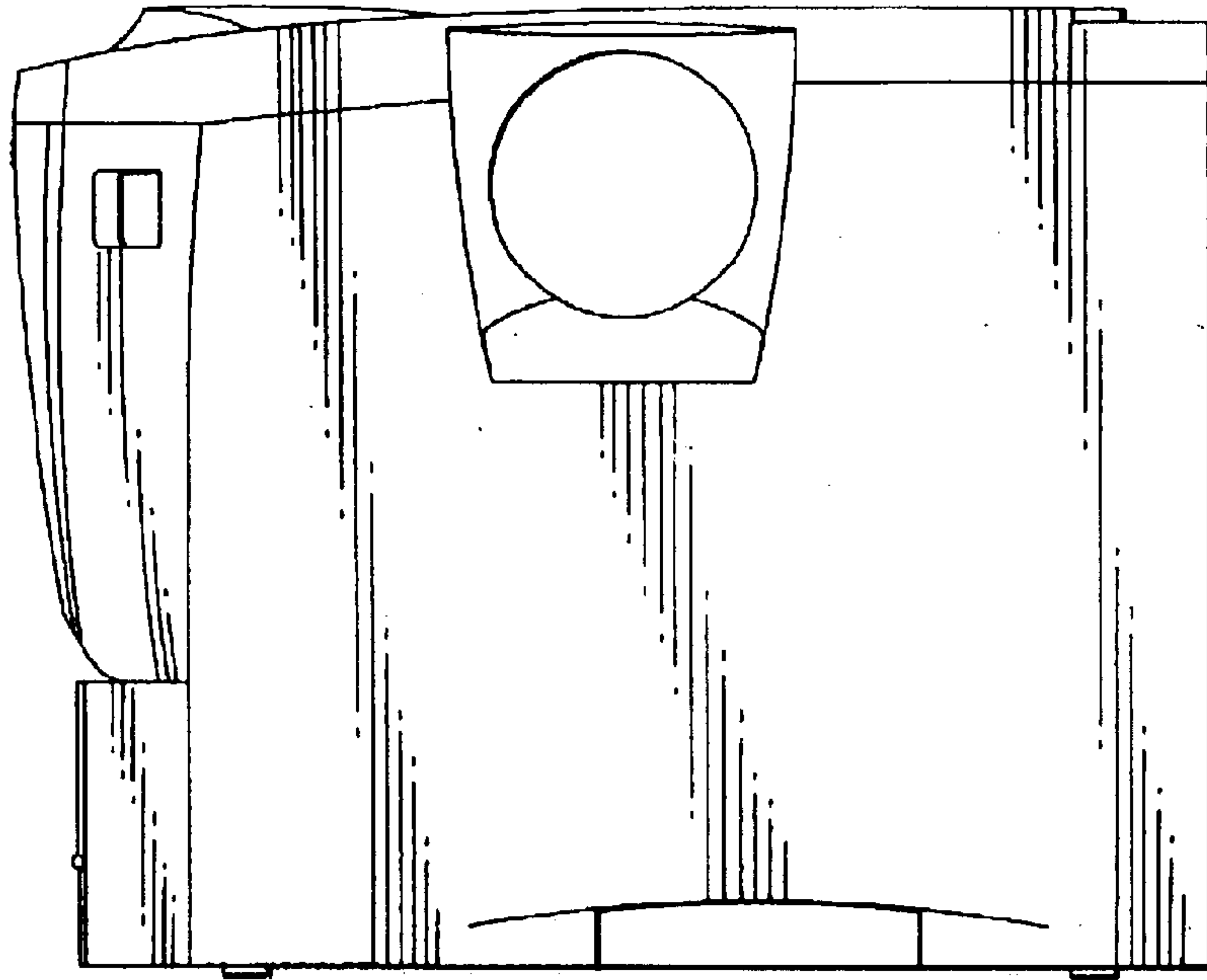

FIG. 6

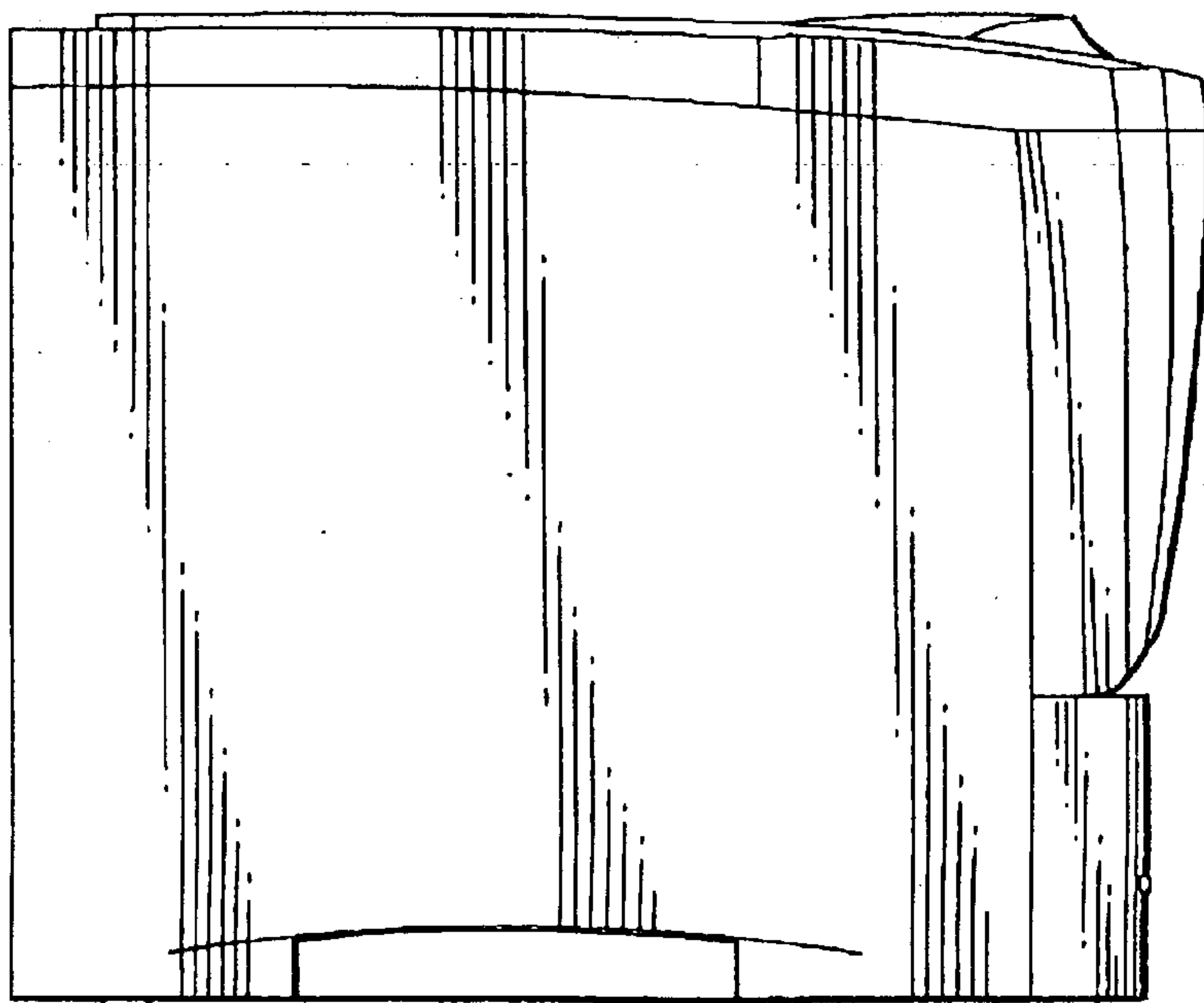

FIG. 7

