

US00D500994S

(12) **United States Design Patent**  
**Lee et al.**

(10) **Patent No.: US D500,994 S**  
(45) **Date of Patent: \*\* Jan. 18, 2005**

(54) **CELLULAR PHONE**

(75) Inventors: **Min-hyoun Lee**, Suwon-si (KR);  
**Chi-young Ahn**, Seoul (KR);  
**Chang-hwan Hwang**, Goyang-si (KR)

(73) Assignee: **Samsung Electronics Co., Ltd.**,  
Suwon-si (KR)

(\*\*) Term: **14 Years**

(21) Appl. No.: **29/205,654**

(22) Filed: **May 19, 2004**

(30) **Foreign Application Priority Data**

Dec. 1, 2003 (KR) ..... 30-2003-0034190

(51) **LOC (7) Cl. .... 14-03**

(52) **U.S. Cl. .... D14/138**

(58) **Field of Search** ..... D14/137, 138,  
D14/218, 147-148, 247-248, 144, 341-347;  
379/433.01-433.13, 419, 434, 428.01-428.04,  
420.01-420.04, 440; 455/550.1-90.3; D21/517;  
D13/168; 345/168, 169

(56) **References Cited**

**U.S. PATENT DOCUMENTS**

- D438,184 S \* 2/2001 Suzuki et al. .... D14/138
- D445,412 S \* 7/2001 Lee et al. .... D14/138
- D458,594 S \* 6/2002 Jang ..... D14/138
- D475,688 S \* 6/2003 Pierce et al. .... D14/138
- D484,478 S \* 12/2003 Kota et al. .... D14/138
- D484,863 S \* 1/2004 Chan ..... D14/138
- D485,248 S \* 1/2004 Ogawa ..... D14/138
- D485,249 S \* 1/2004 Liao et al. .... D14/138
- D485,818 S \* 1/2004 Yabe et al. .... D14/138
- D486,461 S \* 2/2004 Seo et al. .... D14/138
- D486,462 S \* 2/2004 Lim ..... D14/138
- D486,809 S \* 2/2004 Hwang ..... D14/138
- D487,443 S \* 3/2004 Yoon ..... D14/138
- D487,444 S \* 3/2004 Yoon ..... D14/138

- D488,453 S \* 4/2004 Chang et al. .... D14/138
- D488,454 S \* 4/2004 Lee ..... D14/138
- D490,065 S \* 5/2004 Shimazu et al. .... D14/138
- D491,547 S \* 6/2004 Cho ..... D14/138
- D492,656 S \* 7/2004 Lee ..... D14/138
- D493,439 S \* 7/2004 Hong et al. .... D14/138
- D495,672 S \* 9/2004 Jeon et al. .... D14/138
- D496,016 S \* 9/2004 Hoo ..... D14/138
- D496,020 S \* 9/2004 Lee ..... D14/138
- 2003/0153283 A1 \* 8/2003 Kuwazoe ..... 455/90
- 2004/0058724 A1 \* 3/2004 Choi ..... 455/575.7
- 2004/0097258 A1 \* 5/2004 Lee et al. .... 455/550.1
- 2004/0097262 A1 \* 5/2004 Lee ..... 455/556.1
- 2004/0109559 A1 \* 6/2004 Lee ..... 379/433.04
- 2004/0110541 A1 \* 6/2004 Choo ..... 455/566
- 2004/0132513 A1 \* 7/2004 Taneda et al. .... 455/575.3
- 2004/0137965 A1 \* 7/2004 Park et al. .... 455/575.1
- 2004/0142718 A1 \* 7/2004 Kim ..... 455/550.1
- 2004/0142734 A1 \* 7/2004 Kim ..... 455/575.1

**FOREIGN PATENT DOCUMENTS**

JP 1155098 \* 10/2002

\* cited by examiner

*Primary Examiner*—Jeffrey Asch  
(74) *Attorney, Agent, or Firm*—Staas & Halsey LLP

(57) **CLAIM**

The ornamental design for a cellular phone, as shown.

**DESCRIPTION**

FIG. 1 is a perspective view of a cellular phone having the present design;  
FIG. 2 is a view of the front thereof;  
FIG. 3 is a view of the rear thereof;  
FIG. 4 is a view of the left side thereof;  
FIG. 5 is a view of the right side thereof;  
FIG. 6 is a view of the top thereof; and,  
FIG. 7 is a view of the bottom thereof.

**1 Claim, 2 Drawing Sheets**

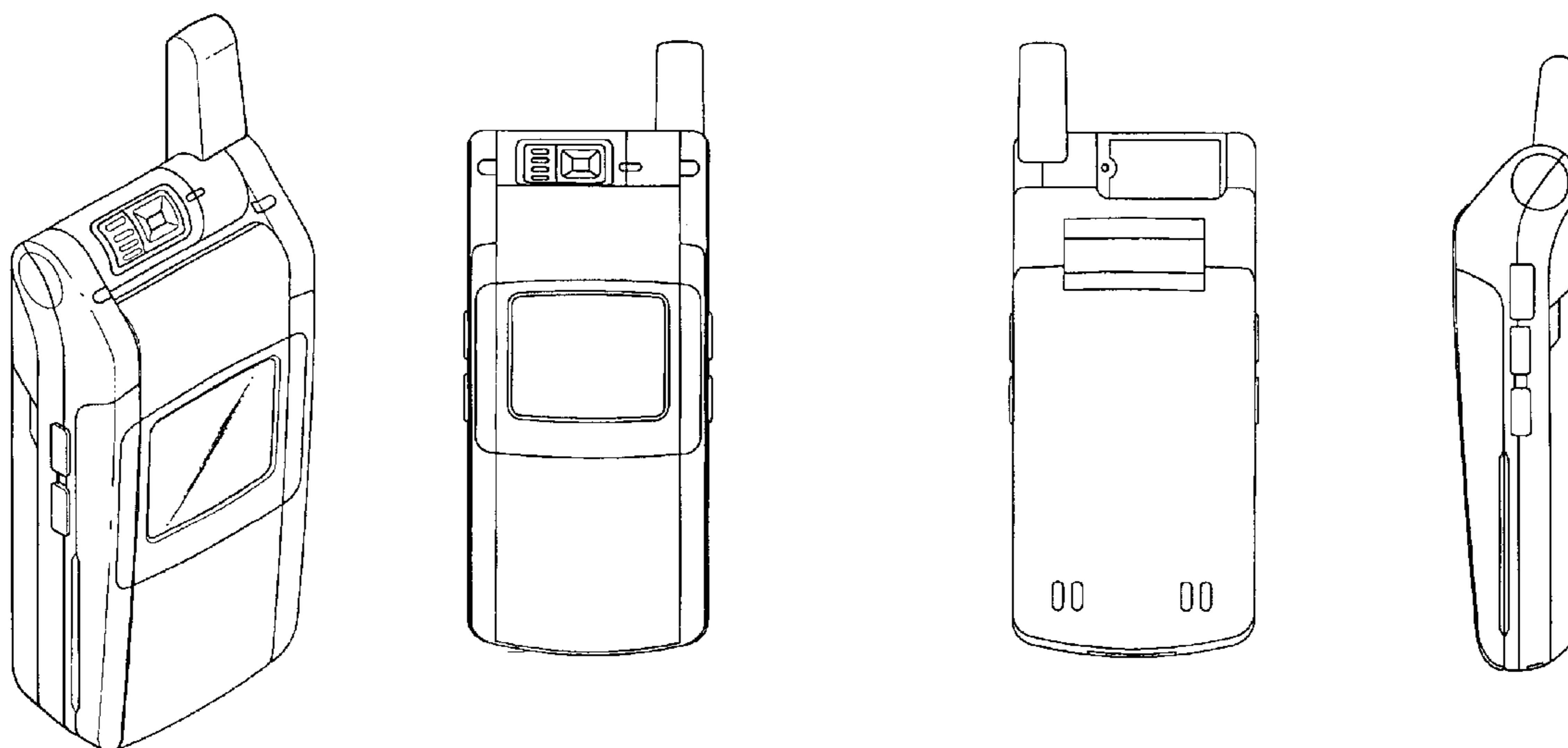

**FIG. 1**

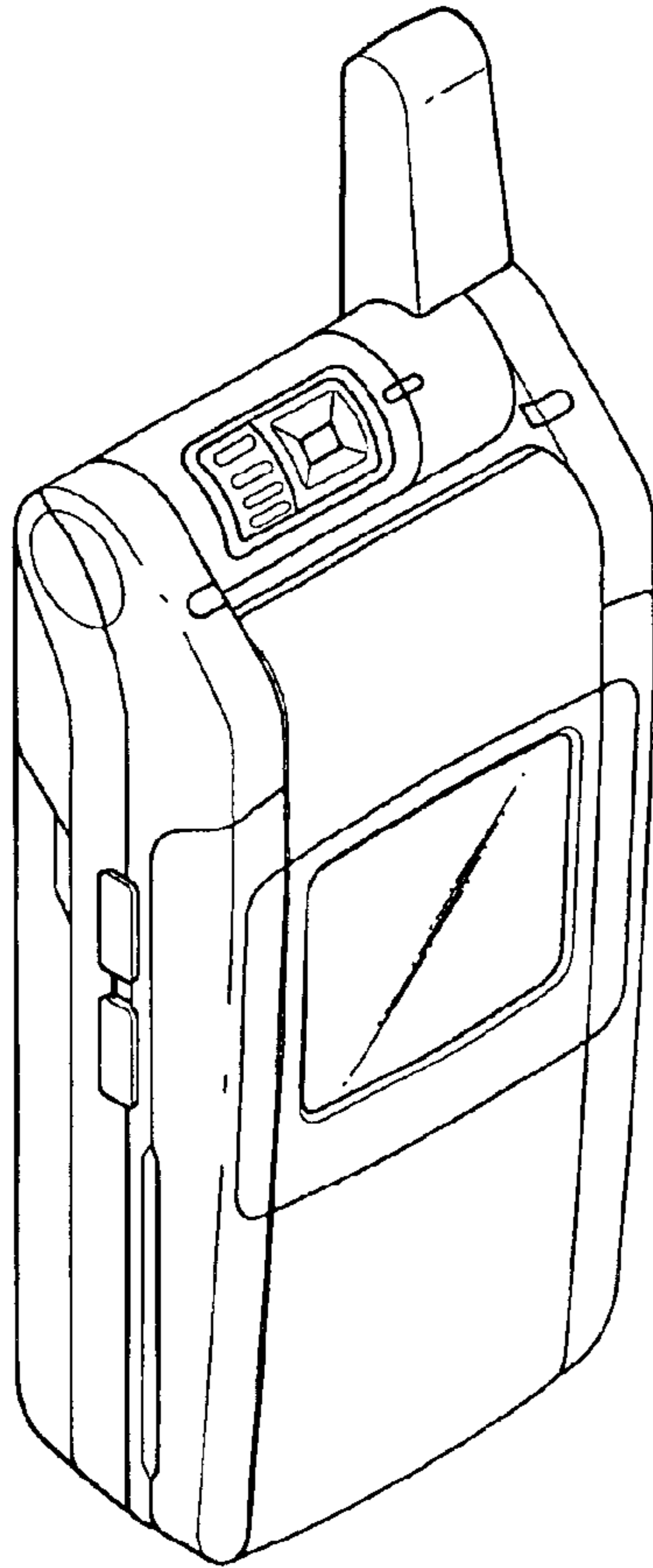

**FIG. 2**

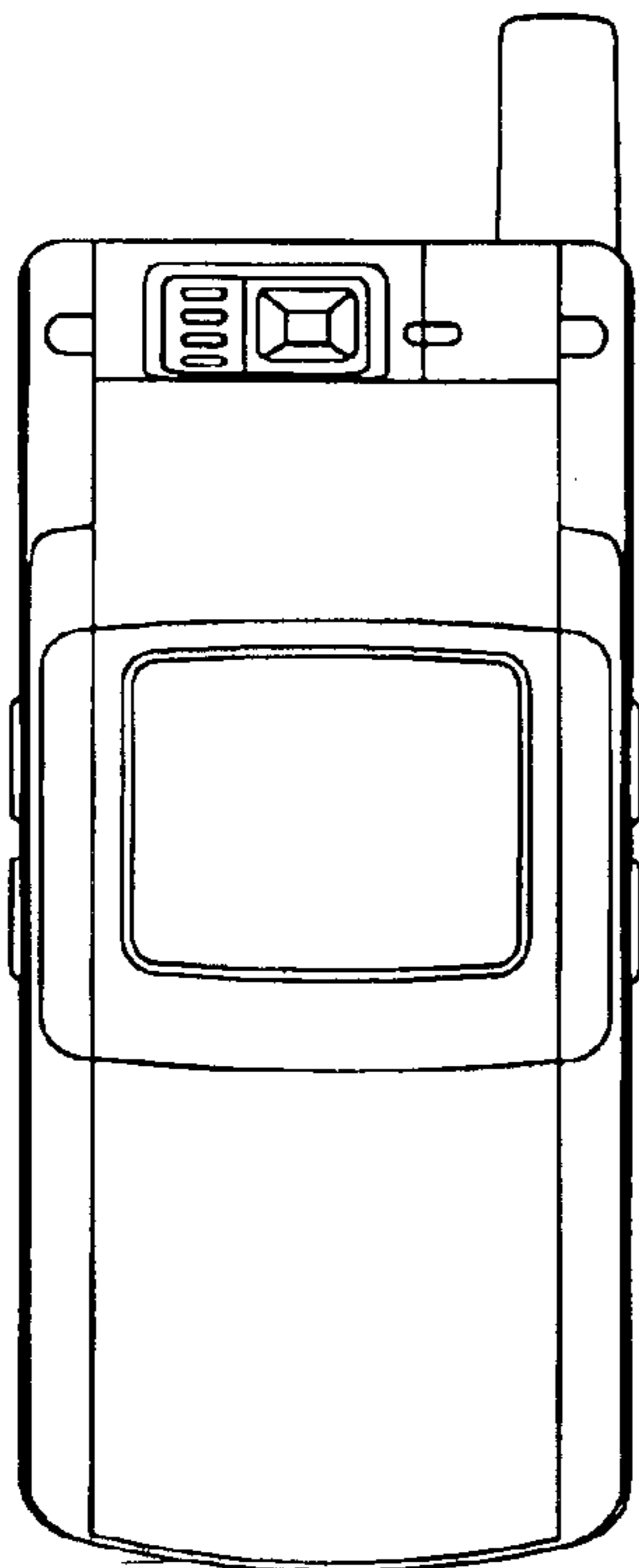

**FIG. 3**

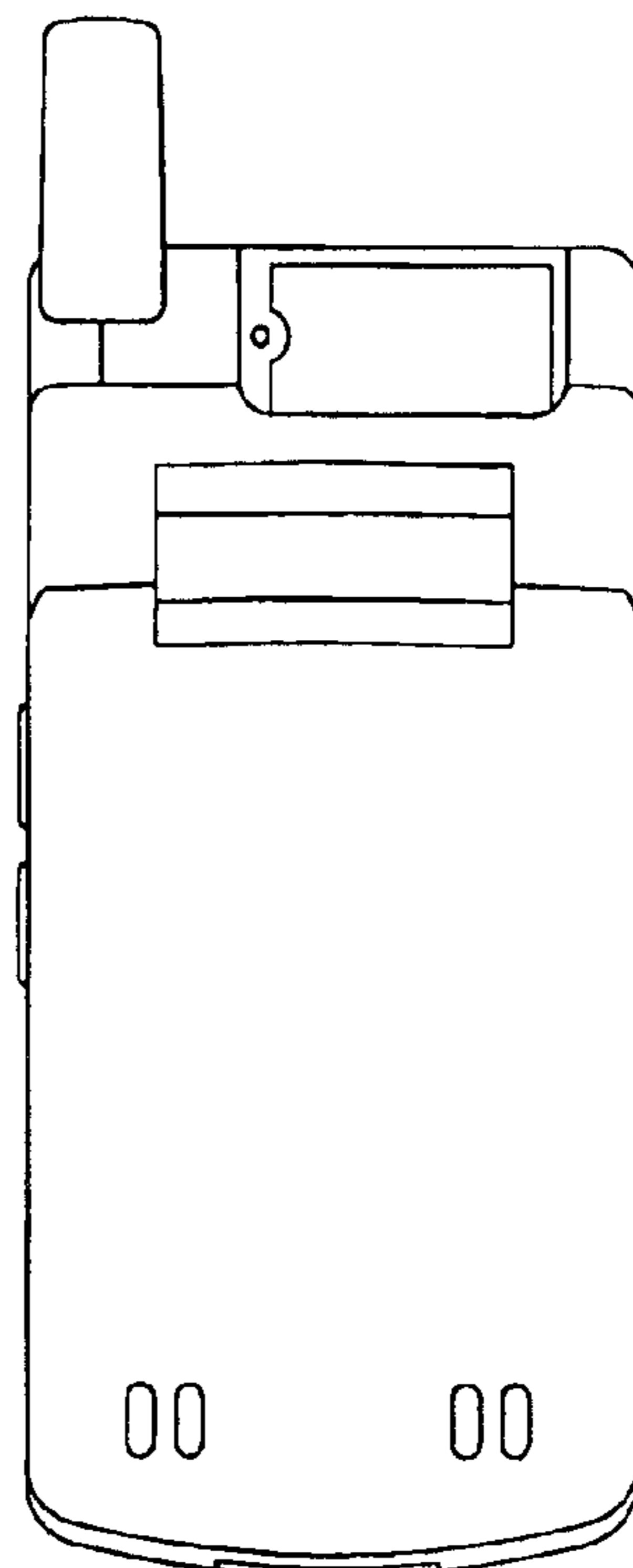

**FIG.4**

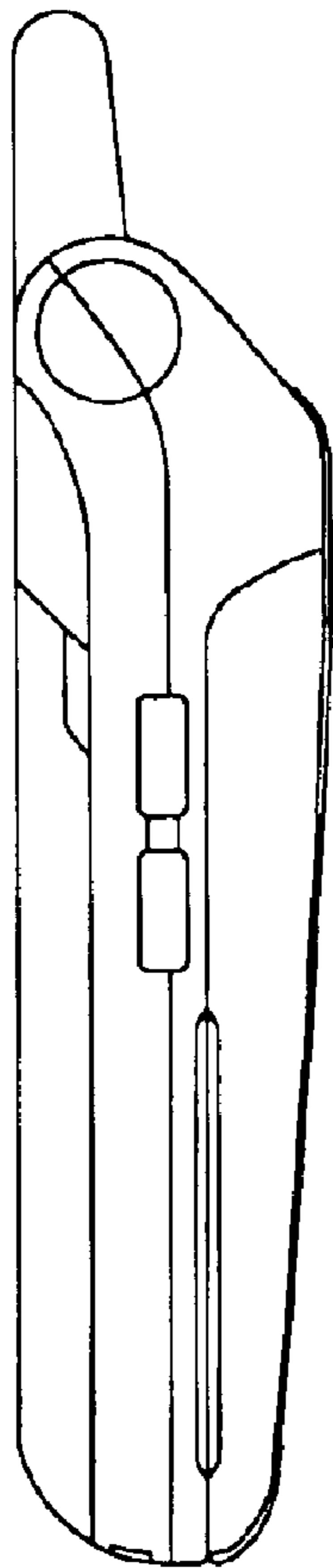

**FIG.5**

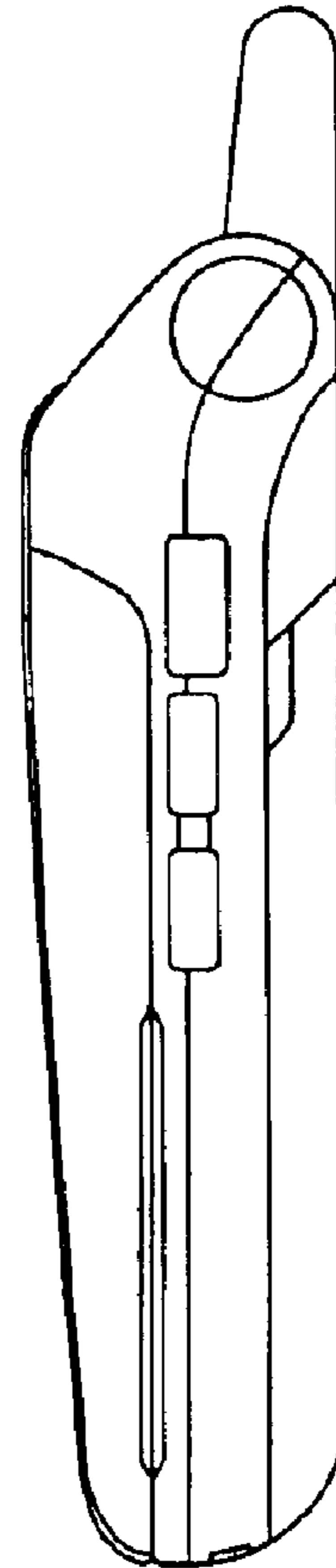

**FIG.6**

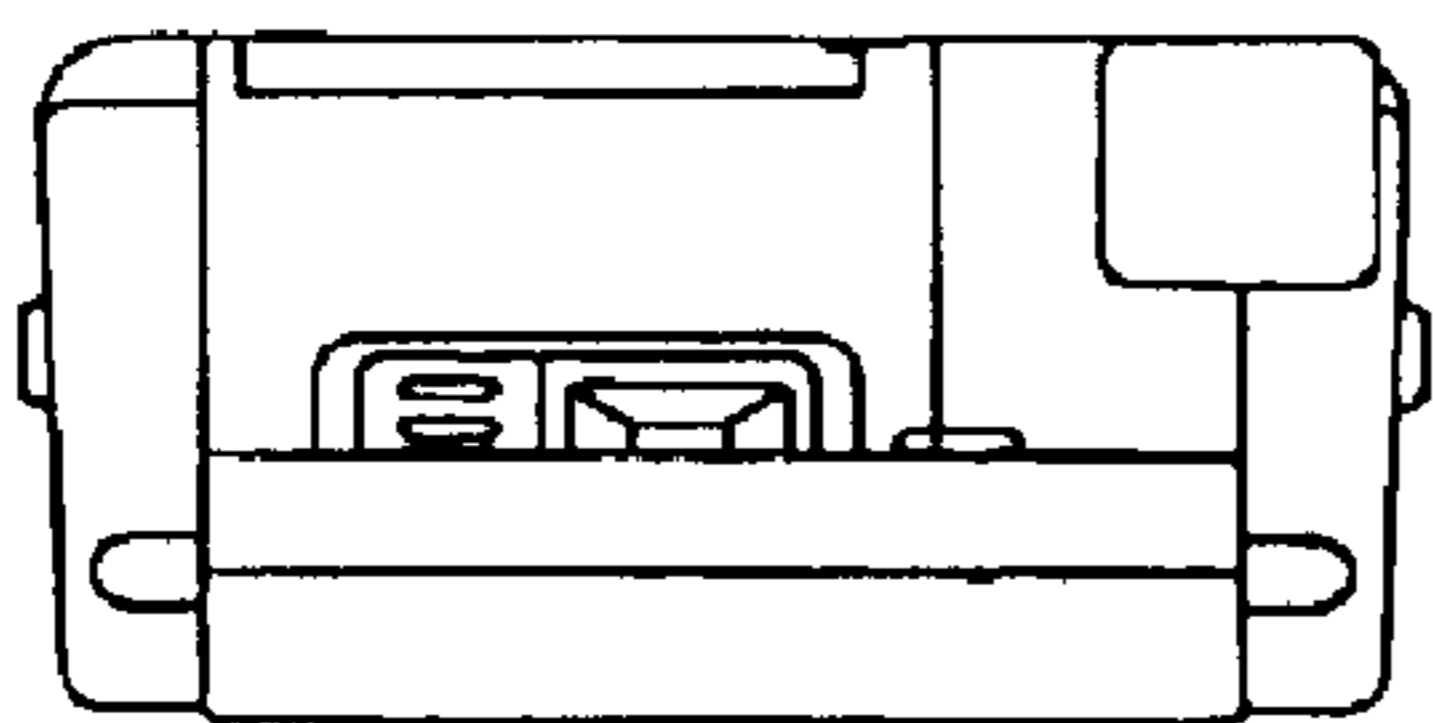

**FIG.7**

