

US00D500949S

(12) **United States Design Patent** (10) **Patent No.:** **US D500,949 S**
Handel et al. (45) **Date of Patent:** **** Jan. 18, 2005**

(54) **LOCK DIAL**

(75) Inventors: **Mark Van Handel**, Milwaukee, WI (US); **Glenn Meekma**, Menomonee Falls, WI (US)

(73) Assignee: **Master Lock Company**, Oak Creek, WI (US)

(**) Term: **14 Years**

(21) Appl. No.: **29/198,525**

(22) Filed: **Jan. 30, 2004**

(51) **LOC (7) Cl.** **08-07**

(52) **U.S. Cl.** **D8/343**

(58) **Field of Search** D8/330, 331, 338, D8/334, 341, 343, 300, 321; 70/14, 21, 22, 23, 51, 52, 258, 286, 431, 334, 332, 333 R, 442-446, 333 A

(56) **References Cited**

U.S. PATENT DOCUMENTS

D95,463 S	*	4/1935	Boref et al.	D8/334
2,690,664 A		10/1954	Miller		
2,725,739 A	*	12/1955	Check	70/285
2,728,215 A	*	12/1955	Bremer	70/332
D205,005 S	*	6/1966	Harrell	D8/334
3,472,040 A	*	10/1969	Sewell	70/21

(List continued on next page.)

Primary Examiner—Prabhakar Deshmukh

(74) *Attorney, Agent, or Firm*—Calfee, Halter & Griswold LLP

(57) **CLAIM**

The ornamental design for a lock dial, as shown and described.

DESCRIPTION

FIG. 1 is a top view of a lock dial of the new design;
FIG. 2 is a front view of the lock dial of FIG. 1;

FIG. 3 is a bottom view of the lock dial of FIG. 1;
FIG. 4 is a side view of the lock dial of FIG. 1;
FIG. 5 is a side view of the lock dial of FIG. 1;
FIG. 6 is a back view of the lock dial of FIG. 1;
FIG. 7 is a front perspective view of the lock dial of FIG. 1;
FIG. 8 is a back perspective view of the lock dial of FIG. 1;
FIG. 9 is a top view of a second embodiment of a lock dial of the new design;
FIG. 10 is a front view of the lock dial of FIG. 9;
FIG. 11 is a bottom view of the lock dial of FIG. 9;
FIG. 12 is a side view of the lock dial of FIG. 9;
FIG. 13 is a side view of the lock dial of FIG. 9;
FIG. 14 is a back view of the lock dial of FIG. 9;
FIG. 15 is a front perspective view of the lock dial of FIG. 9;
FIG. 16 is a back perspective view of the lock dial of FIG. 9;
FIG. 17 is a top view of a third embodiment of a lock dial of the new design;
FIG. 18 is a front view of the lock dial of FIG. 17;
FIG. 19 is a bottom view of the lock dial of FIG. 17;
FIG. 20 is a side view of the lock dial of FIG. 17;
FIG. 21 is a side view of the lock dial of FIG. 17;
FIG. 22 is a back view of the lock dial of FIG. 17;
FIG. 23 is a front perspective view of the lock dial of FIG. 17;
FIG. 24 is a back perspective view of the lock dial of FIG. 17;
FIG. 25 is a top view of a fourth embodiment of a lock dial of the new design;
FIG. 26 is a front view of the lock dial of FIG. 25;
FIG. 27 is a bottom view of the lock dial of FIG. 25;
FIG. 28 is a side view of the lock dial of FIG. 25;
FIG. 29 is a side view of the lock dial of FIG. 25;
FIG. 30 is a back view of the lock dial of FIG. 25;
FIG. 31 is a front perspective view of the lock dial of FIG. 25; and,
FIG. 32 is a back perspective view of the lock dial of FIG. 25.

1 Claim, 12 Drawing Sheets

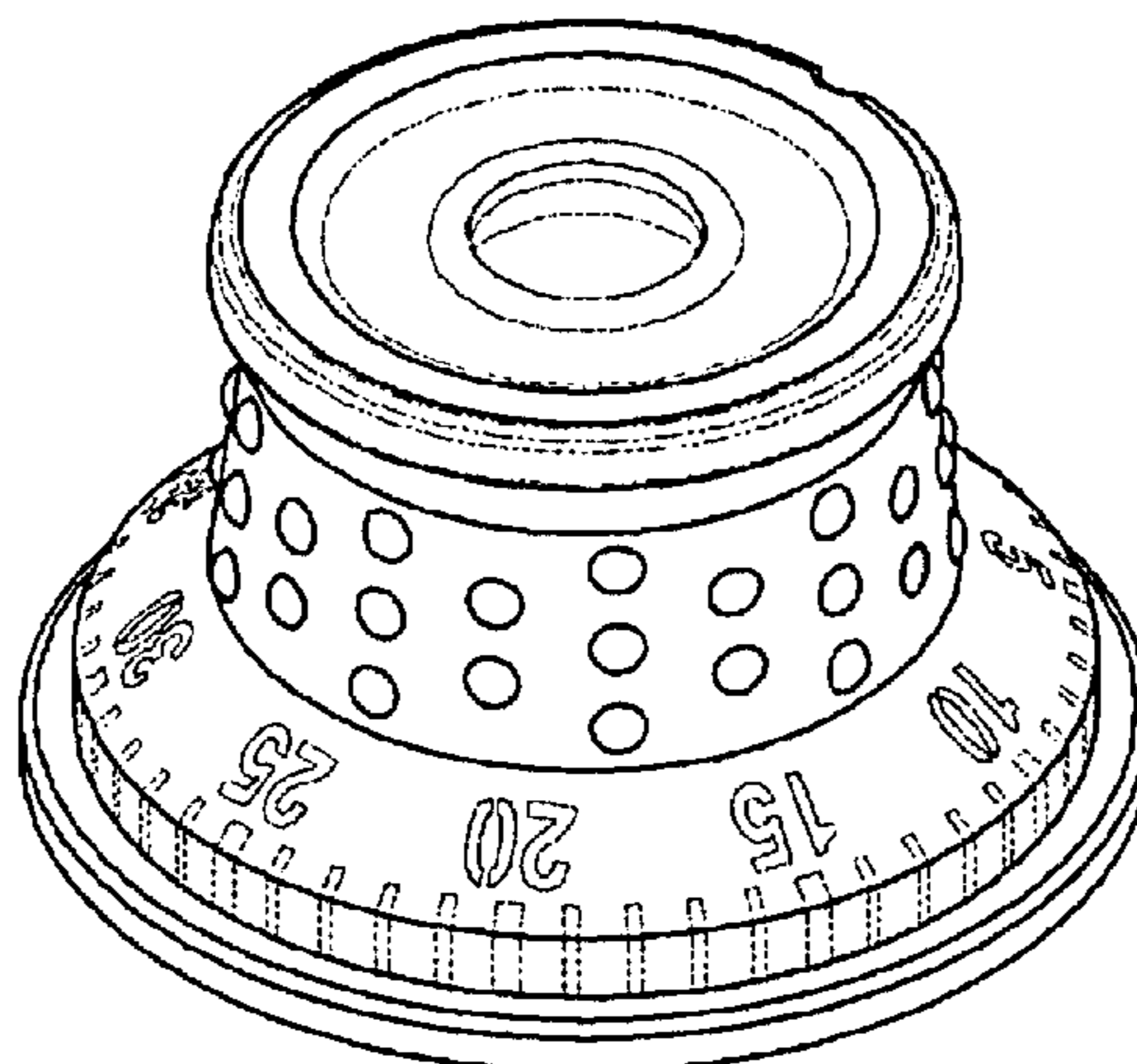

US D500,949 S

Page 2

U.S. PATENT DOCUMENTS

3,536,017	A	*	10/1970	Lucas	109/1	R	D391,834	S	*	3/1998	Phillips	D8/343
D251,965	S		5/1979	Uyeda				D396,798	S	*	8/1998	Adelmeyer et al.	D8/343
4,197,726	A	*	4/1980	Uyeda	70/332		D418,392	S		1/2000	Kelley		
4,404,823	A	*	9/1983	Miller et al.	70/333	A	D459,971	S		7/2002	Quan et al.		
4,462,231	A		7/1984	Zabel				6,494,067	B1	*	12/2002	Jasper	70/278.1
D276,408	S		11/1984	Zabel				D473,446	S		4/2003	Quan et al.		

* cited by examiner

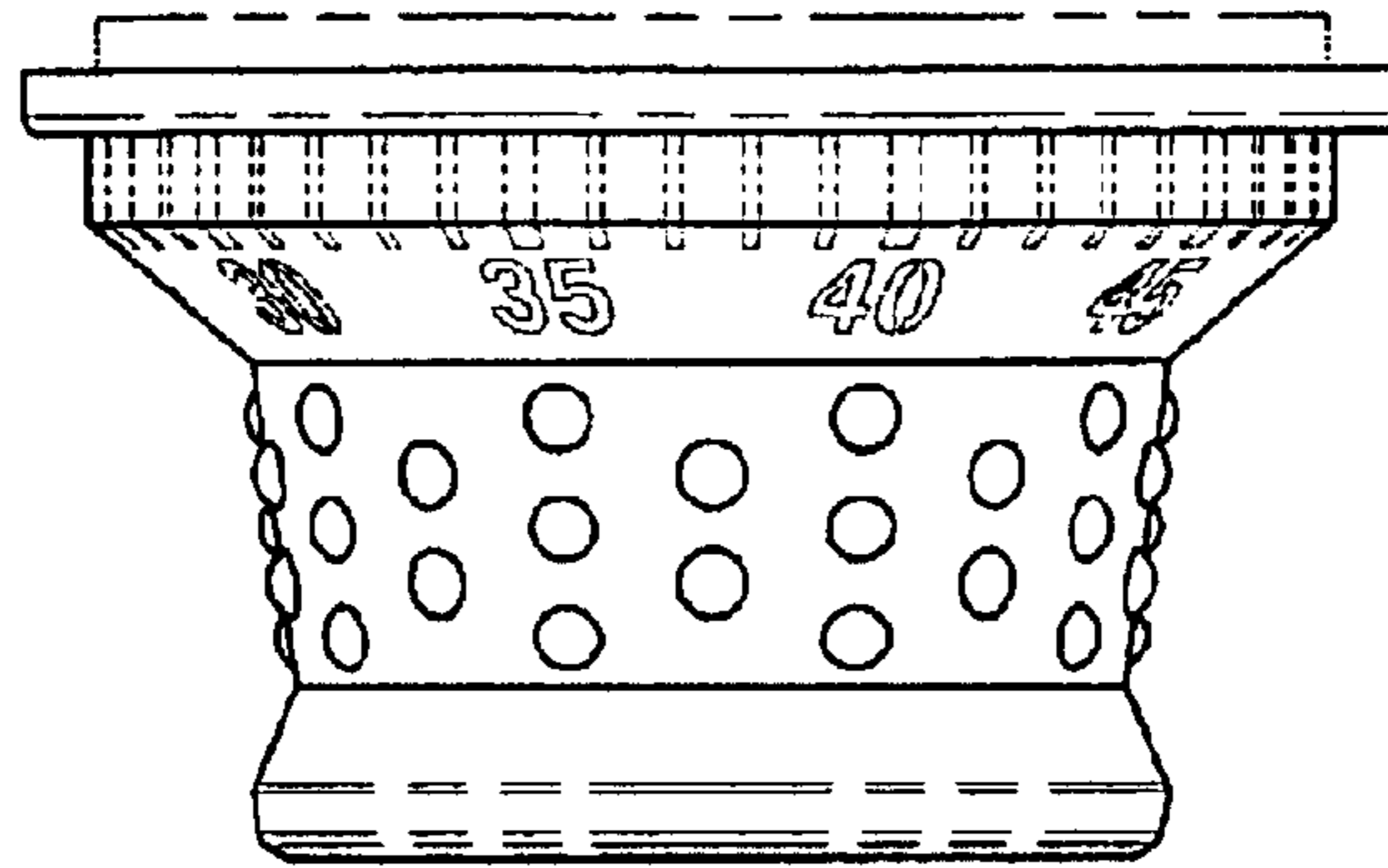

FIG. 1

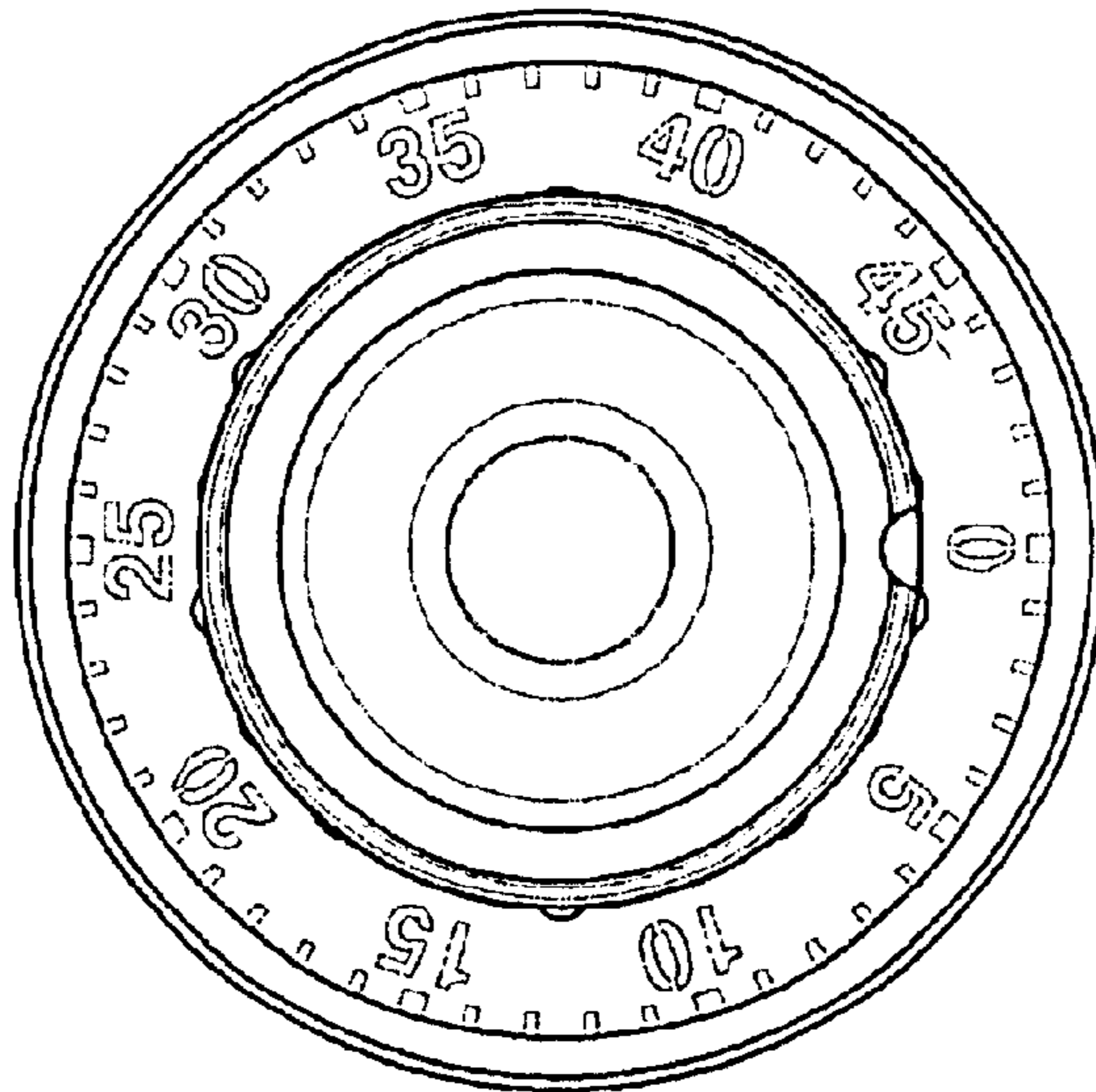

FIG. 2

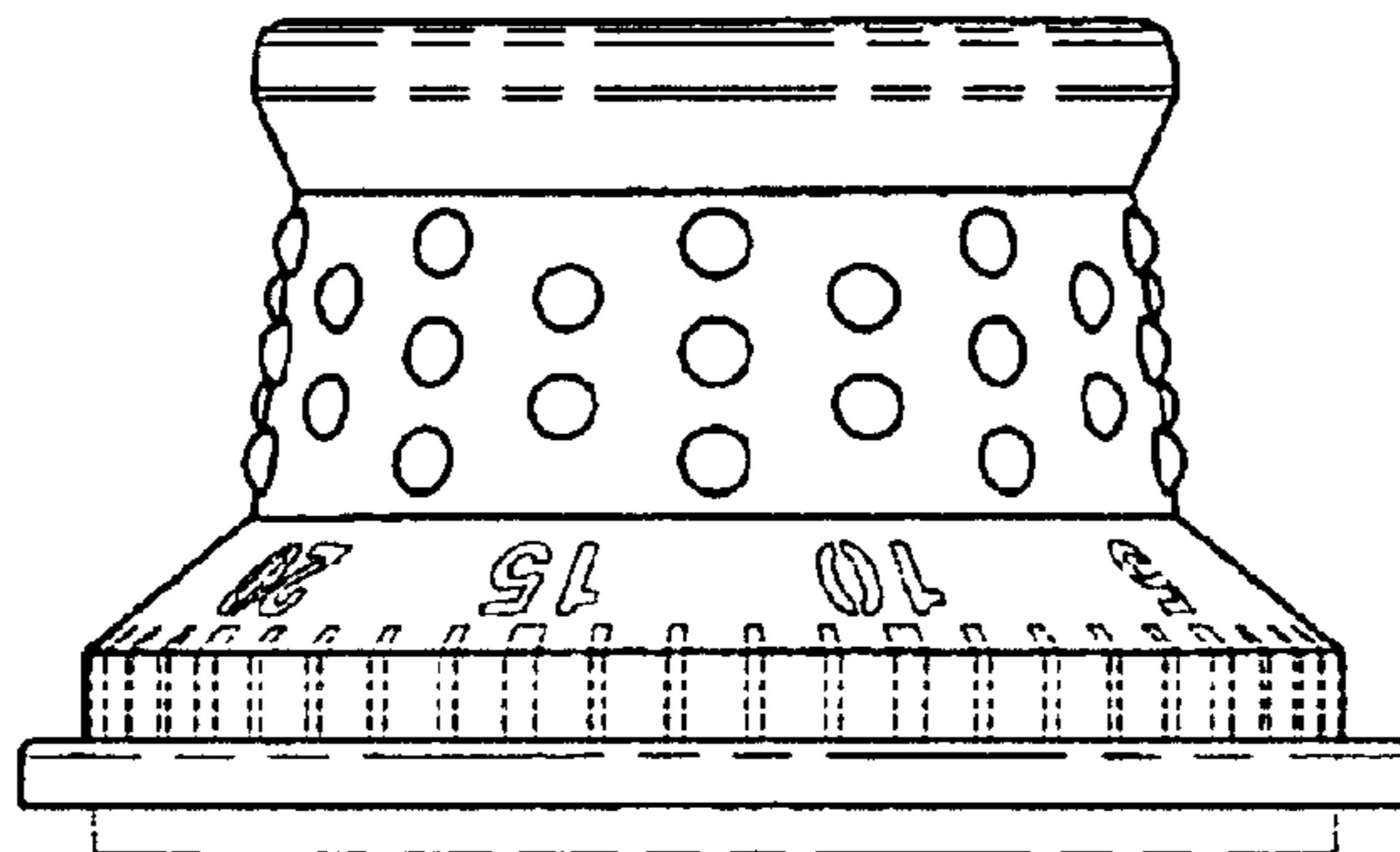

FIG. 3

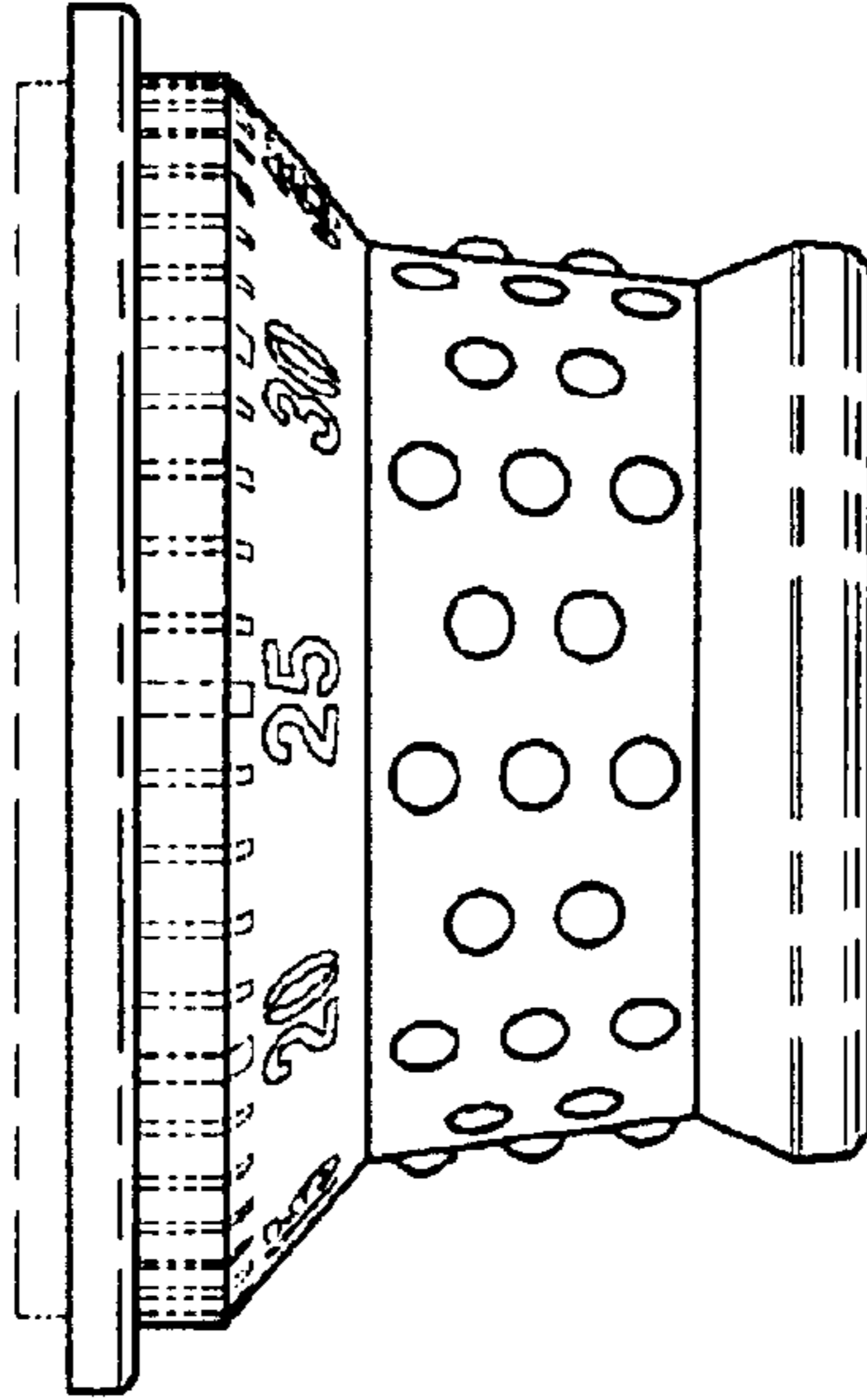

FIG. 4

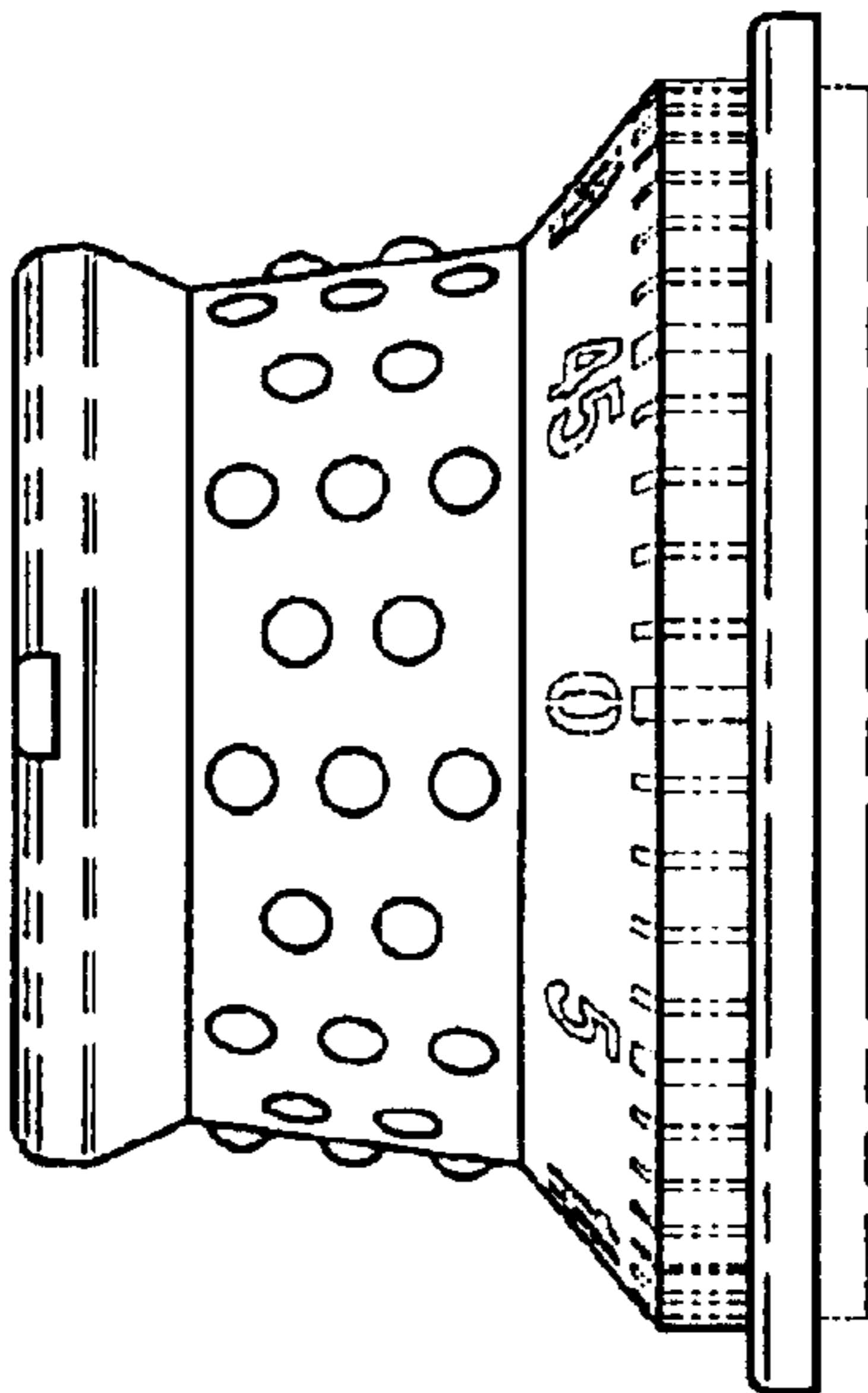

FIG. 5

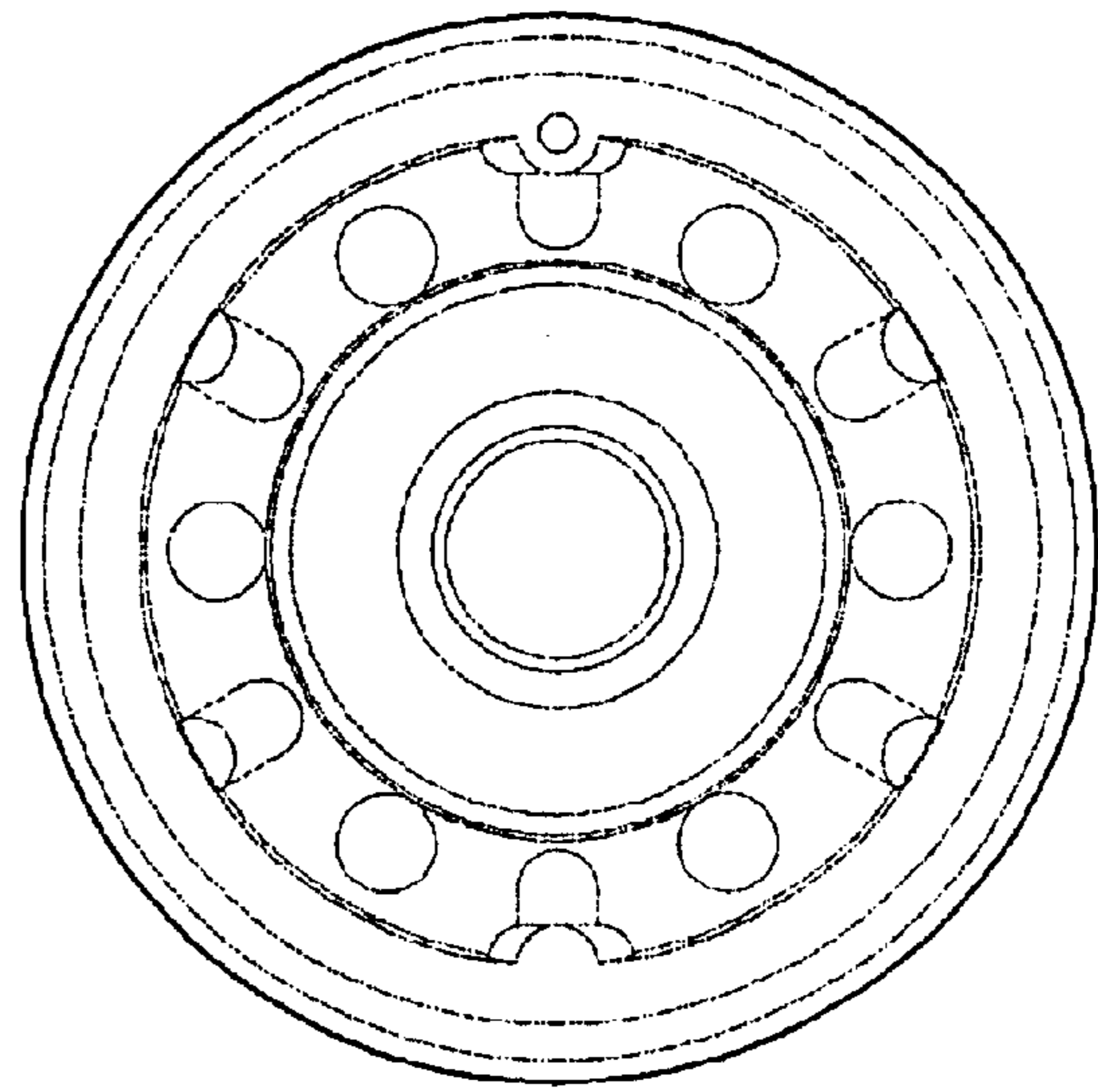

FIG. 6

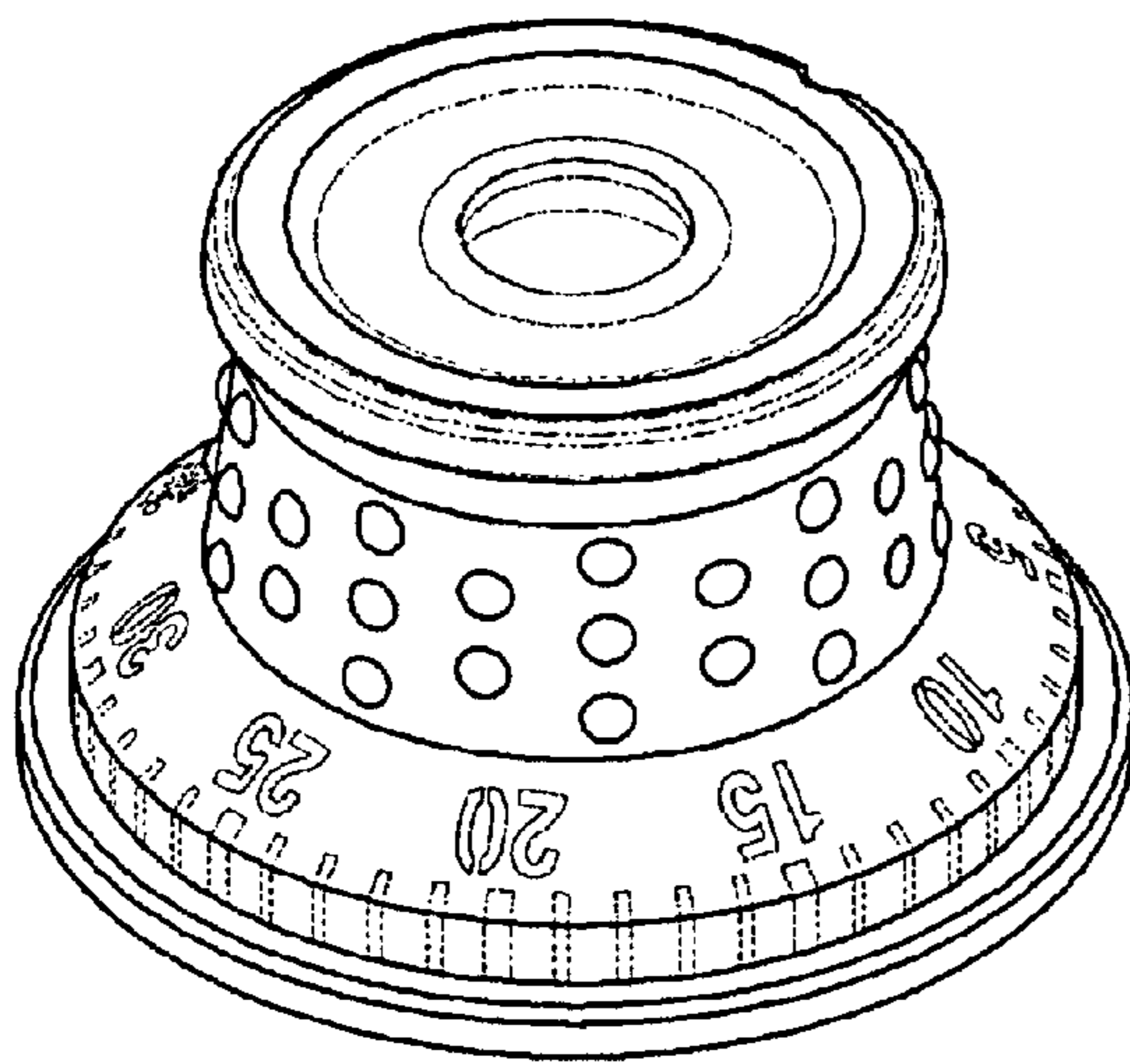

FIG. 7

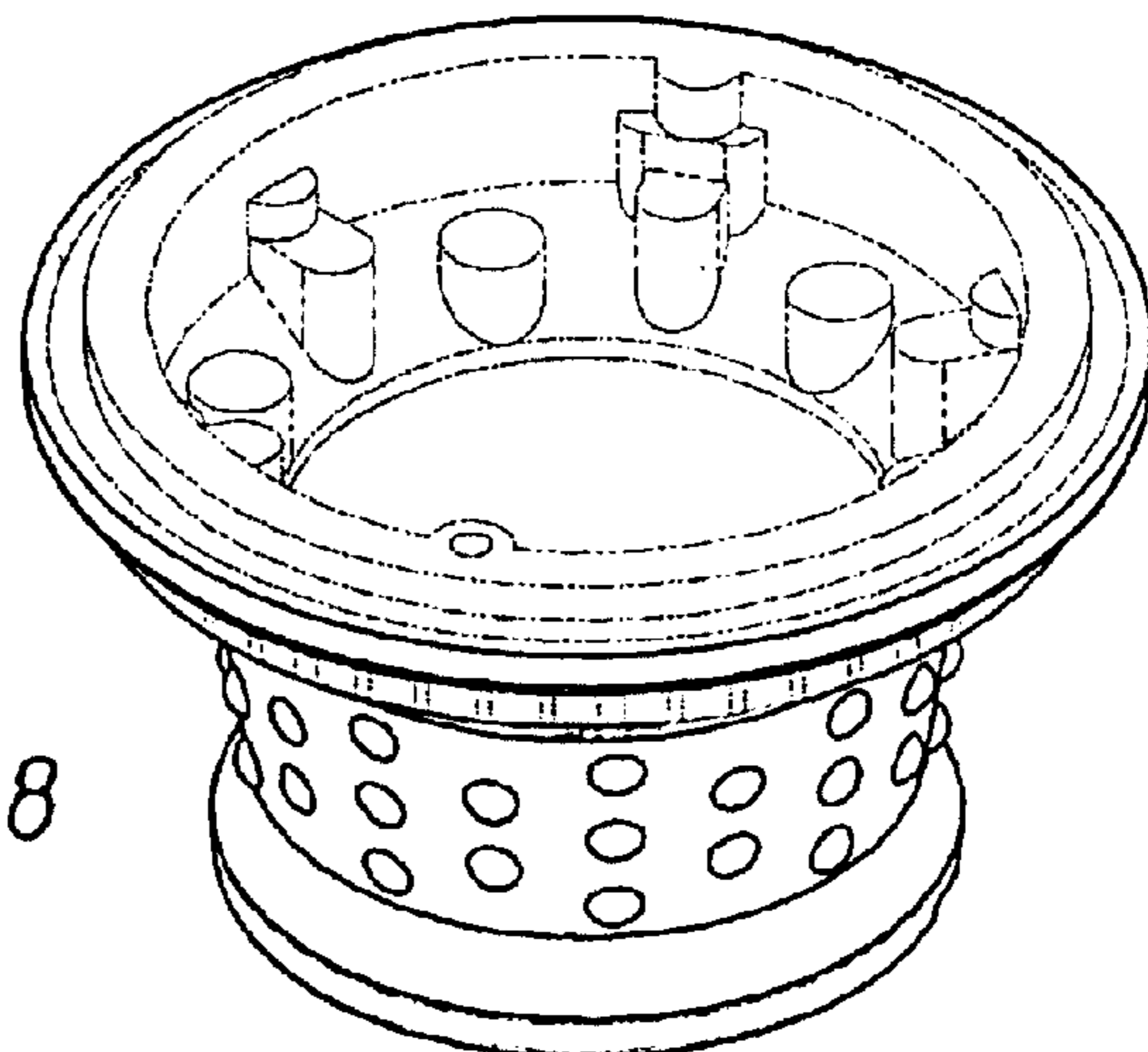

FIG. 8

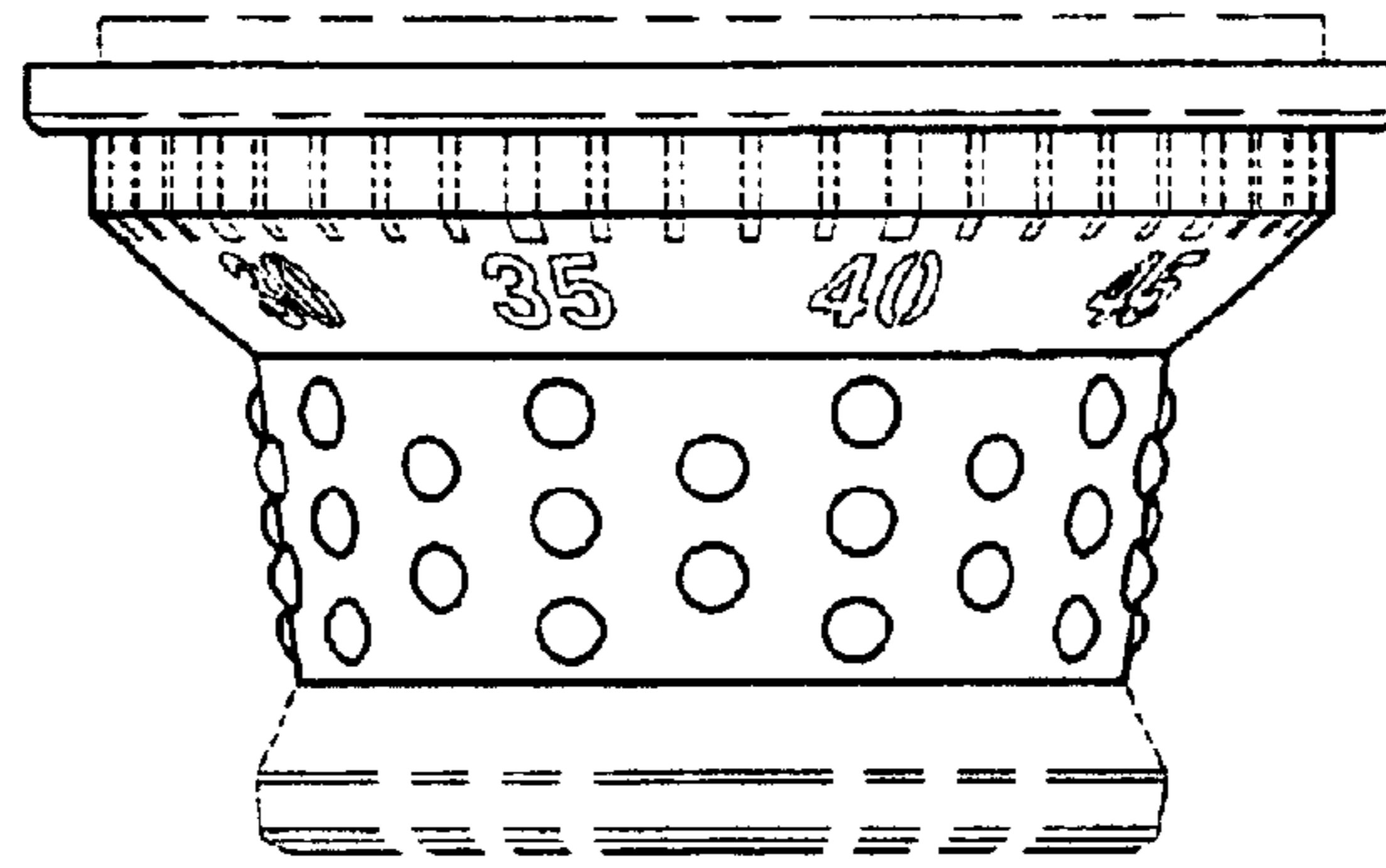

FIG. 9

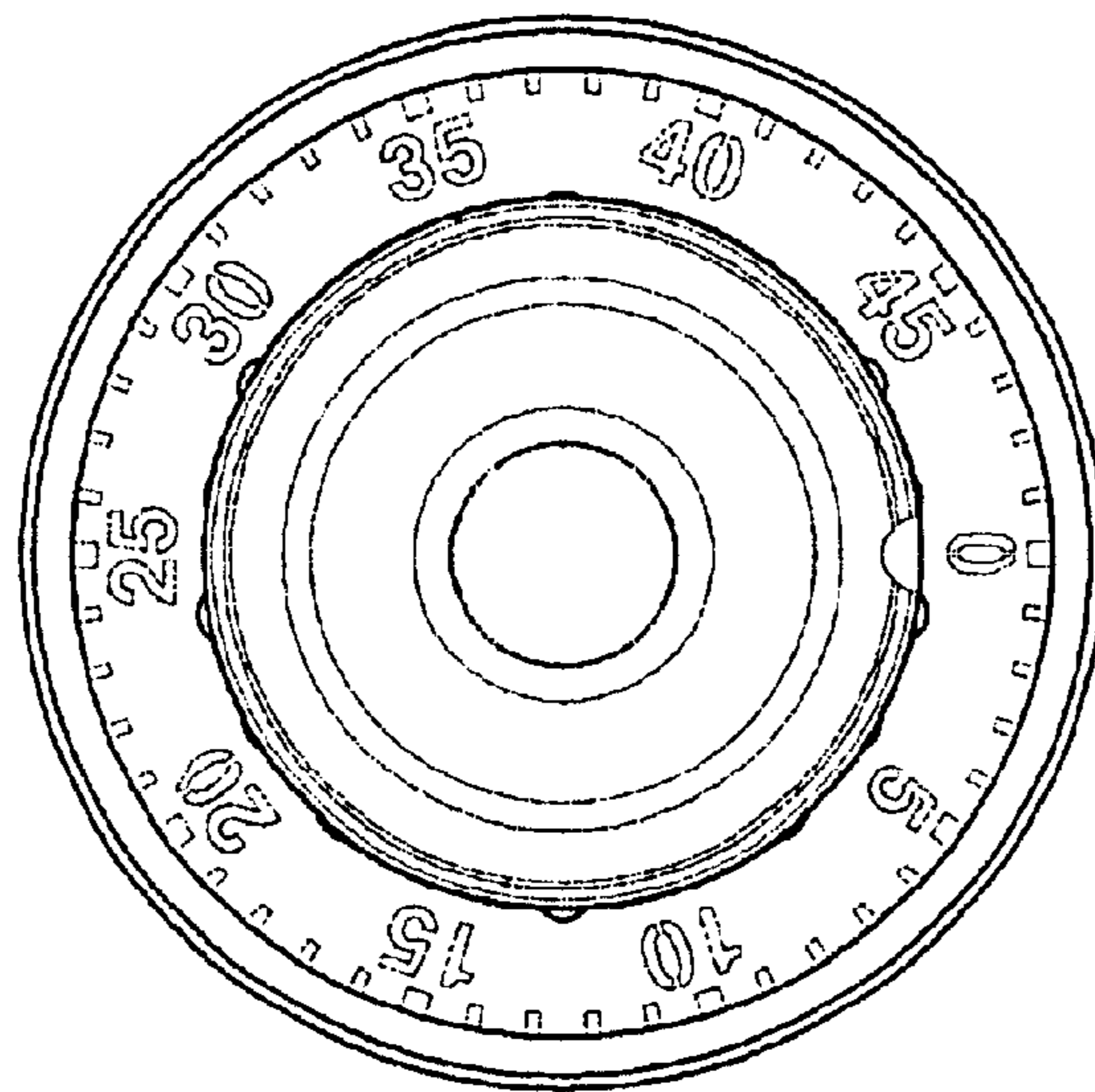

FIG. 10

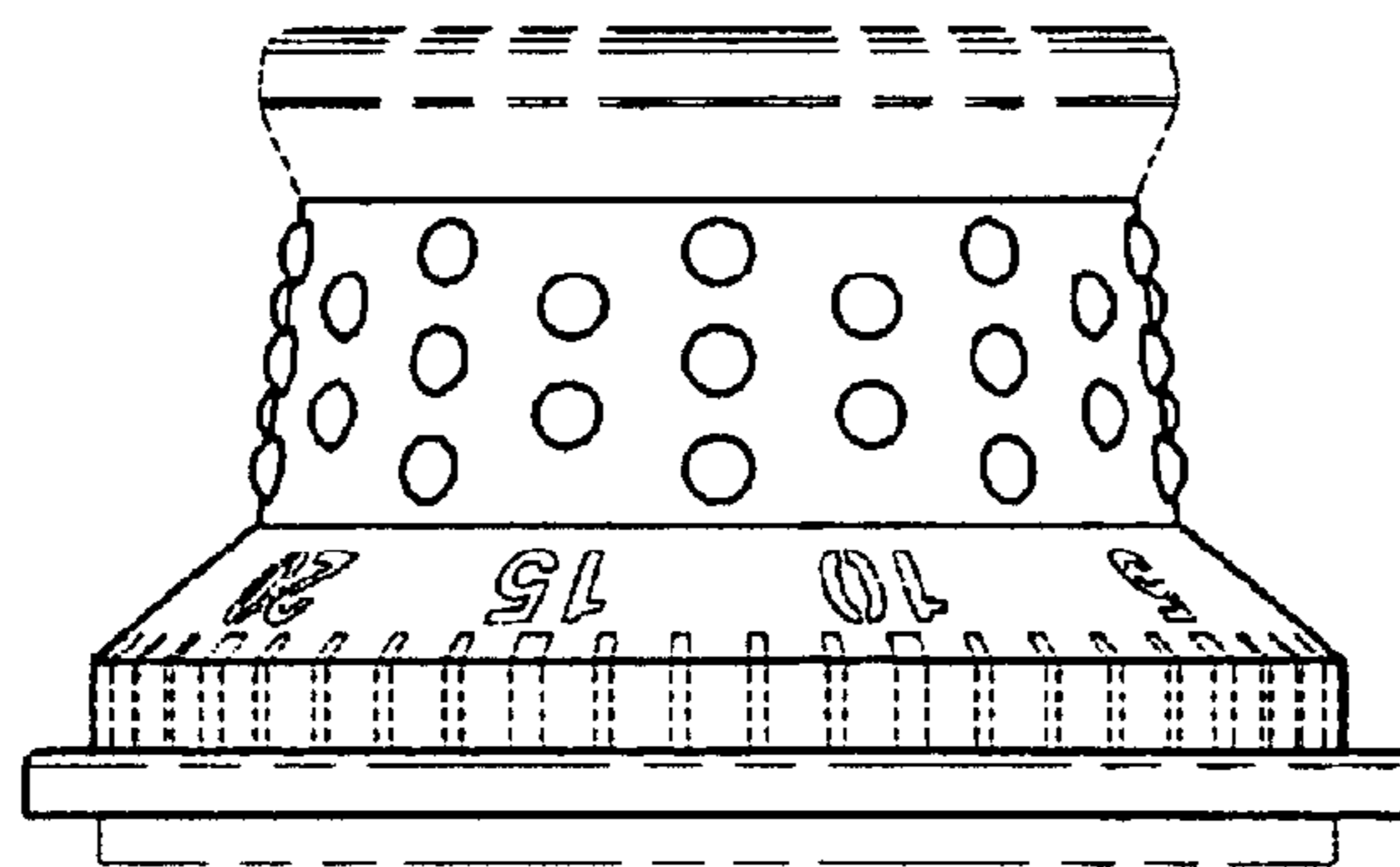

FIG. 11

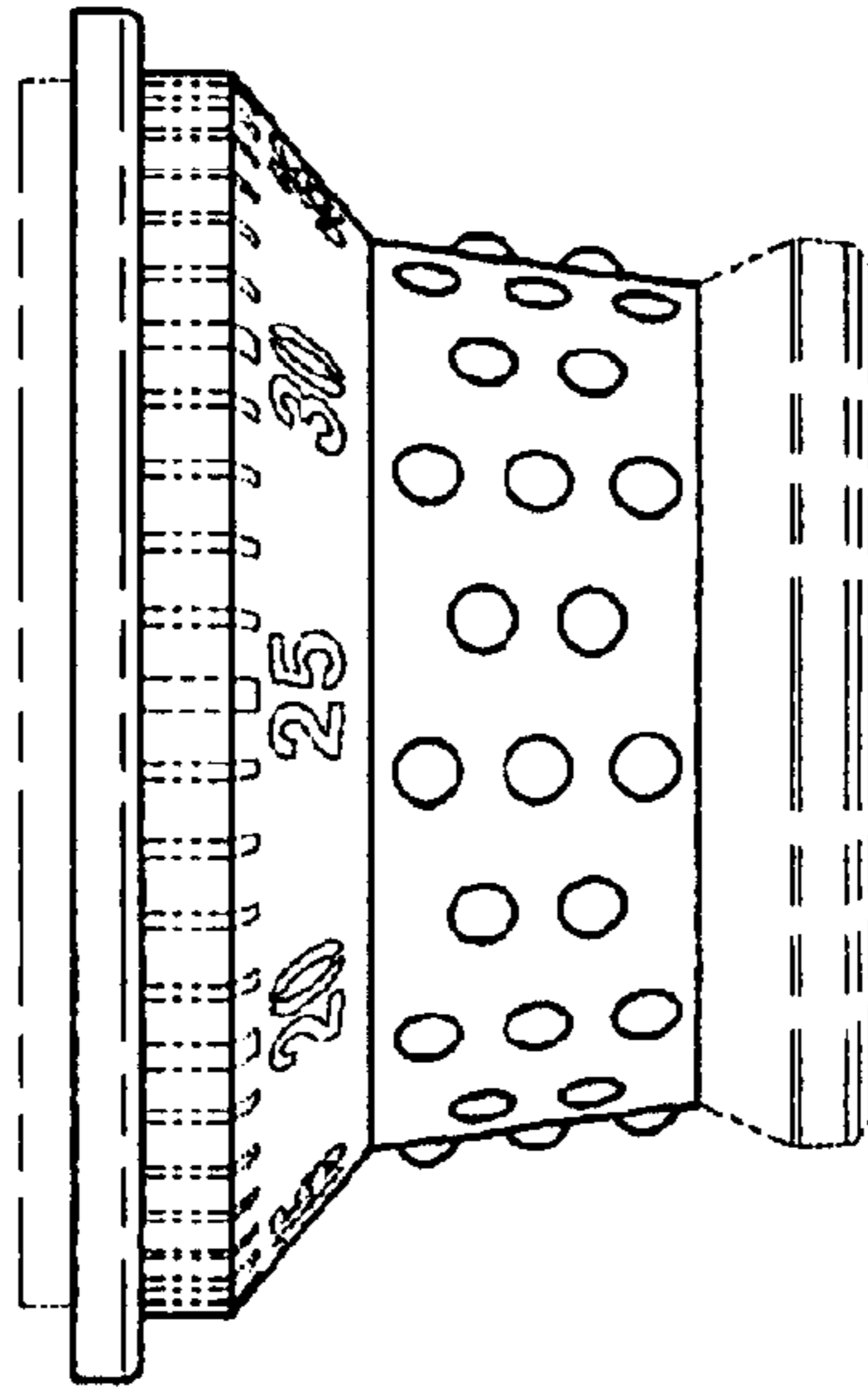

FIG. 12

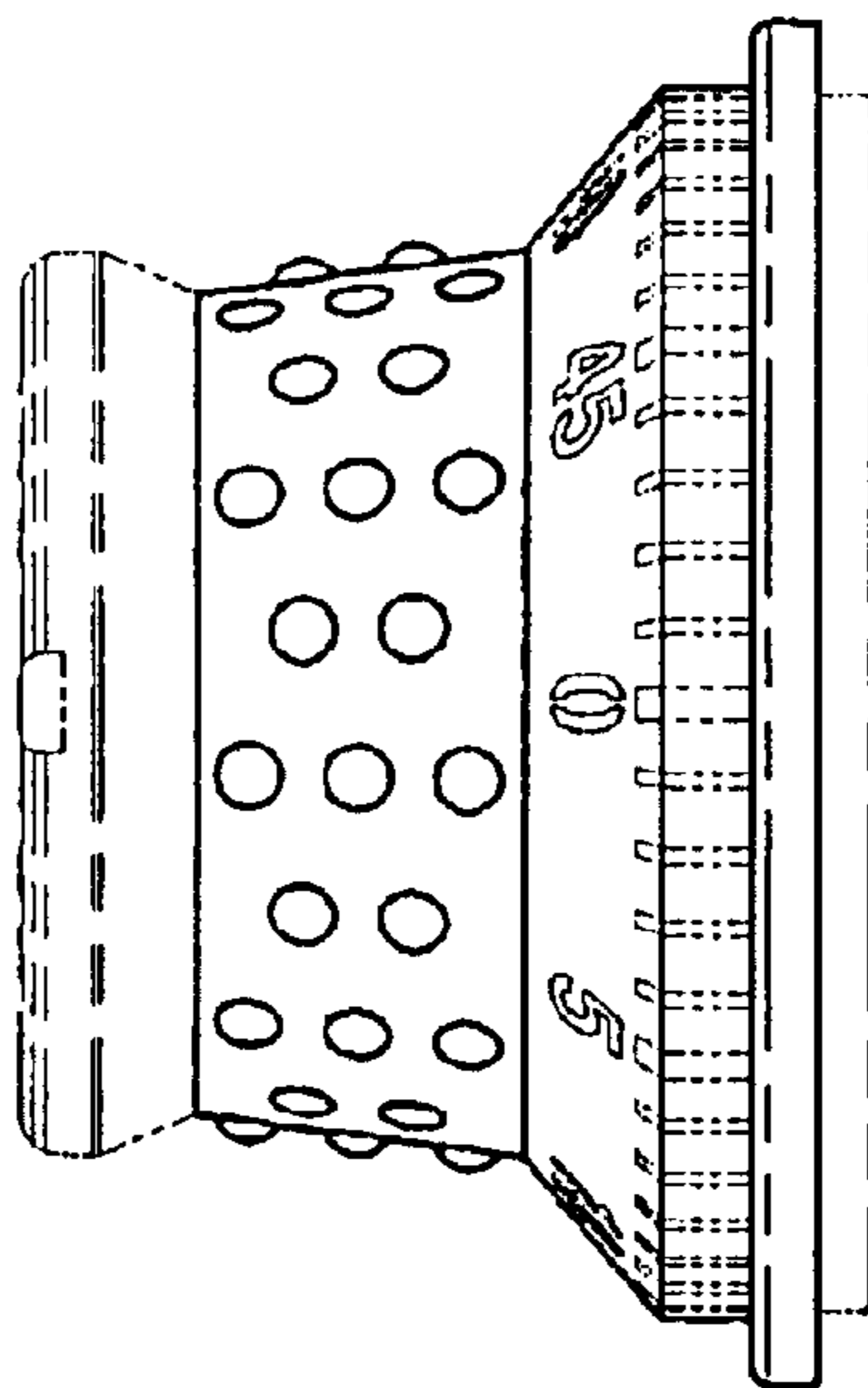

FIG. 13

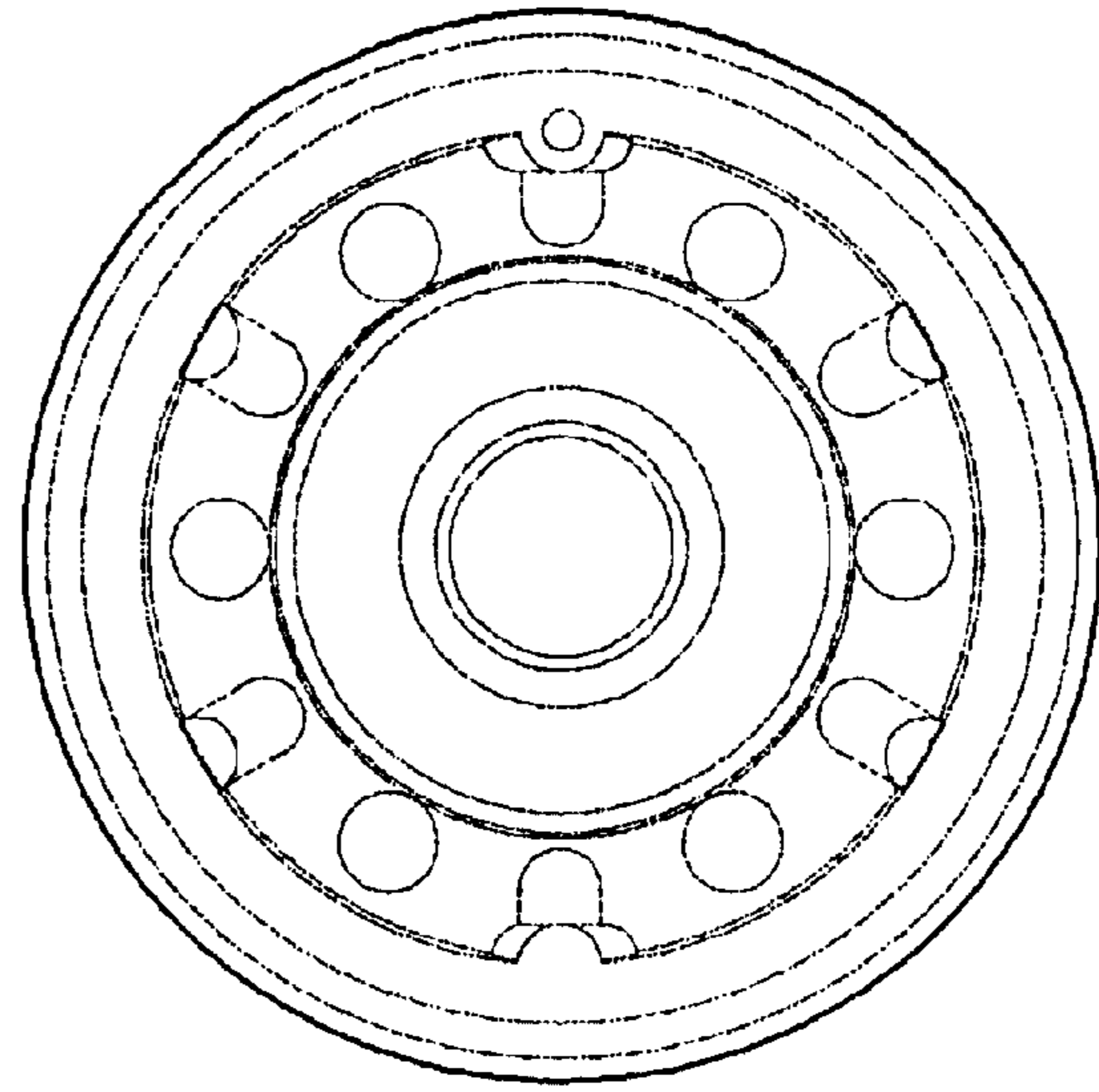

FIG. 14

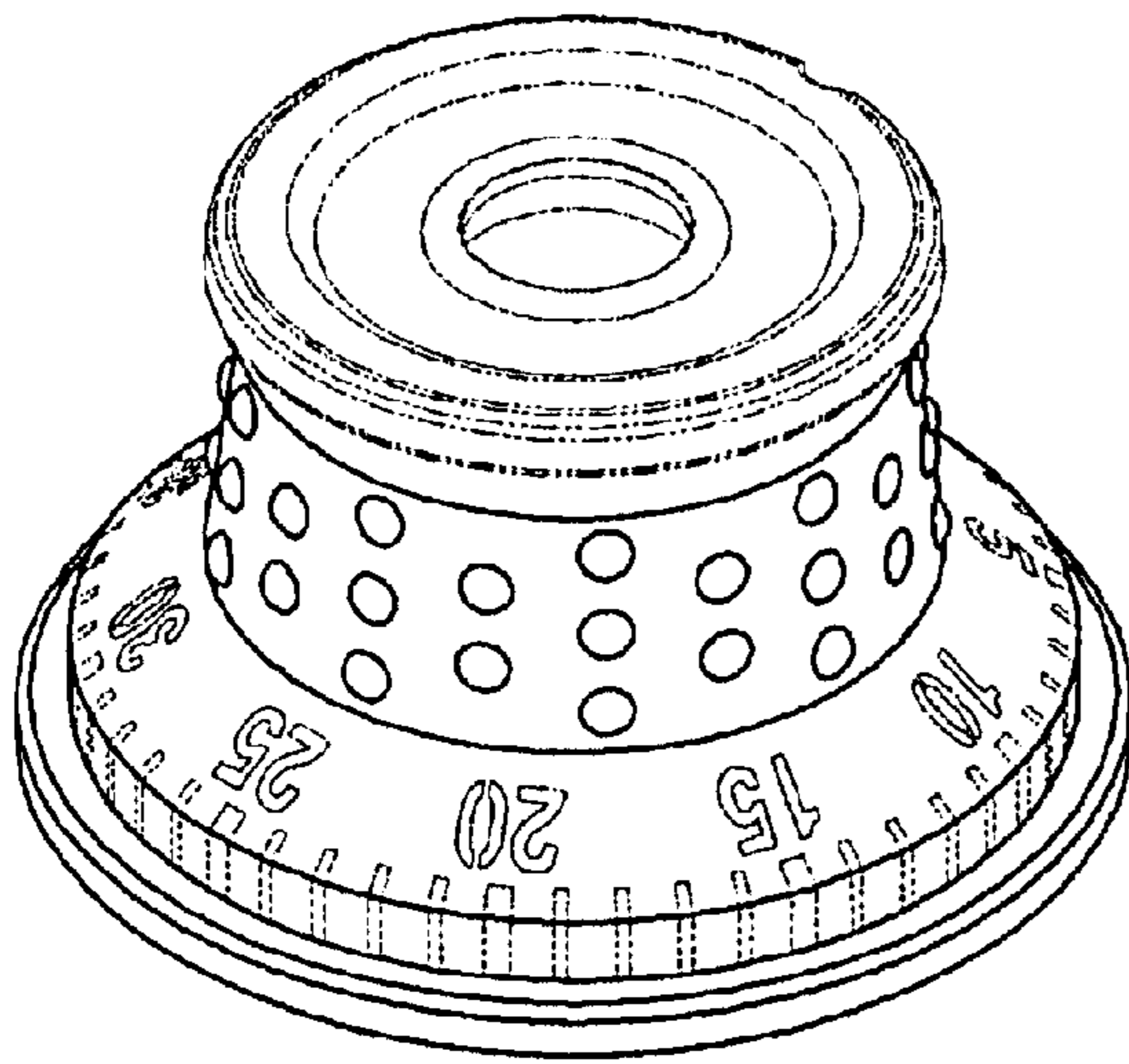

FIG. 15

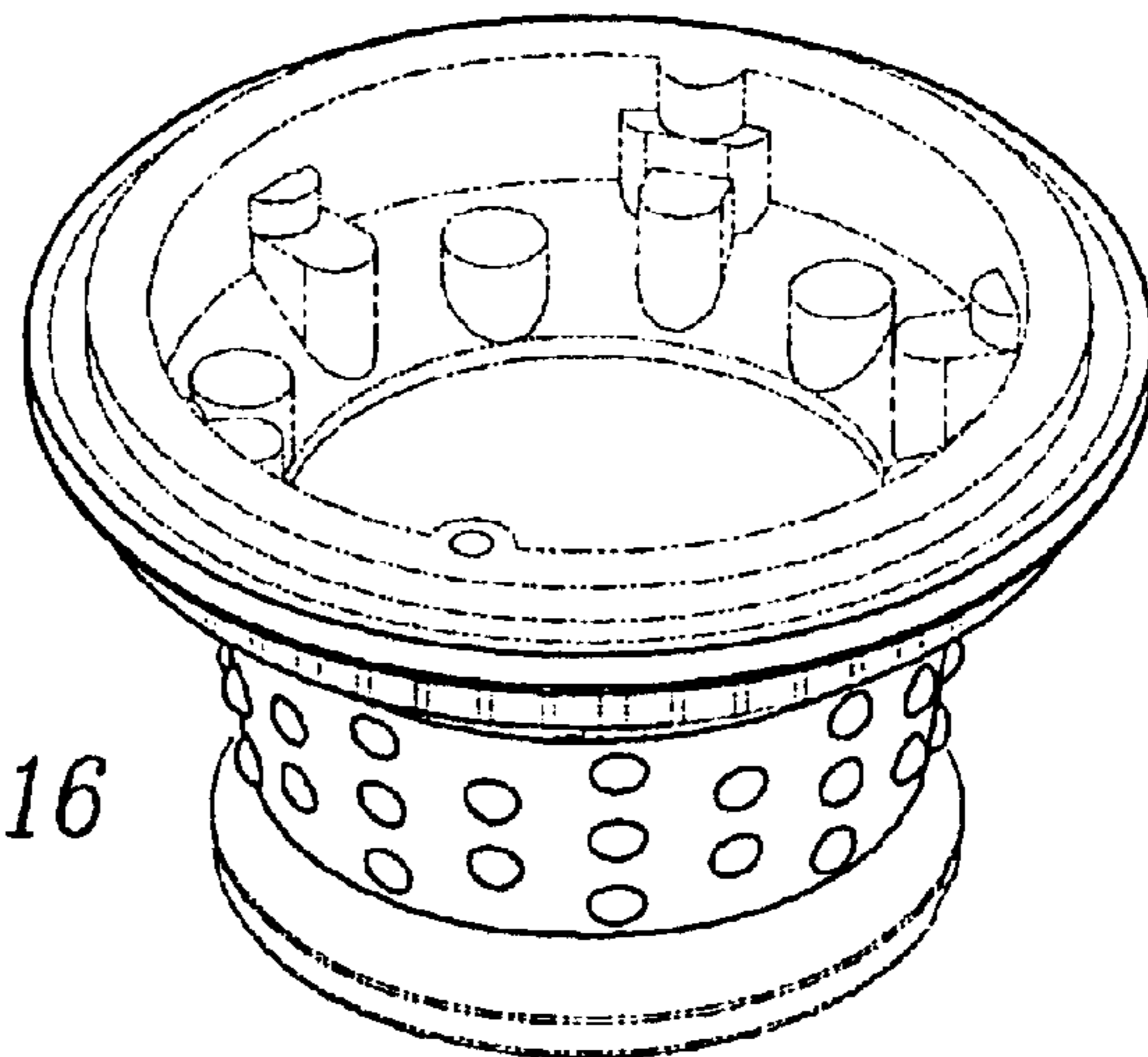

FIG. 16

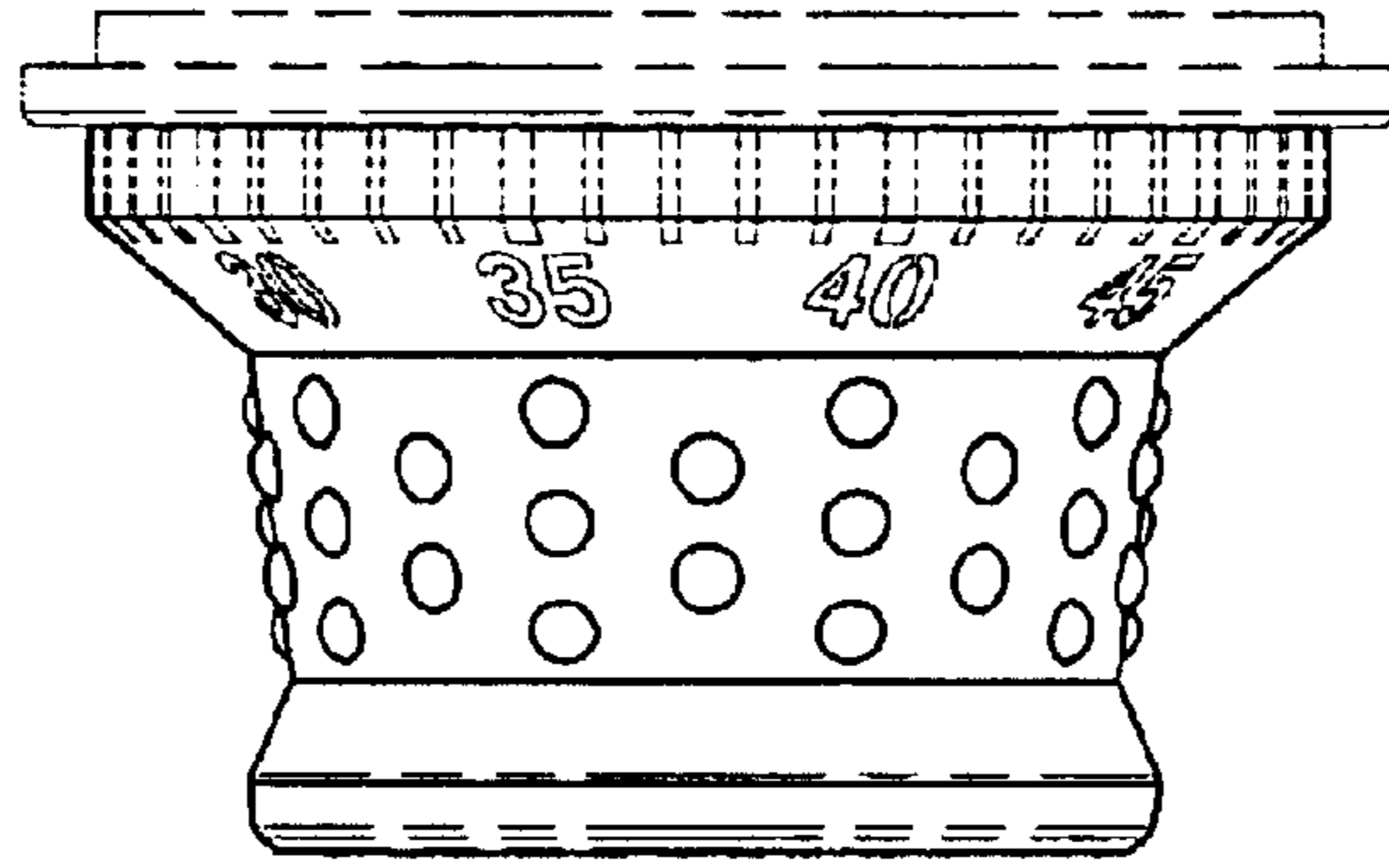

FIG. 17

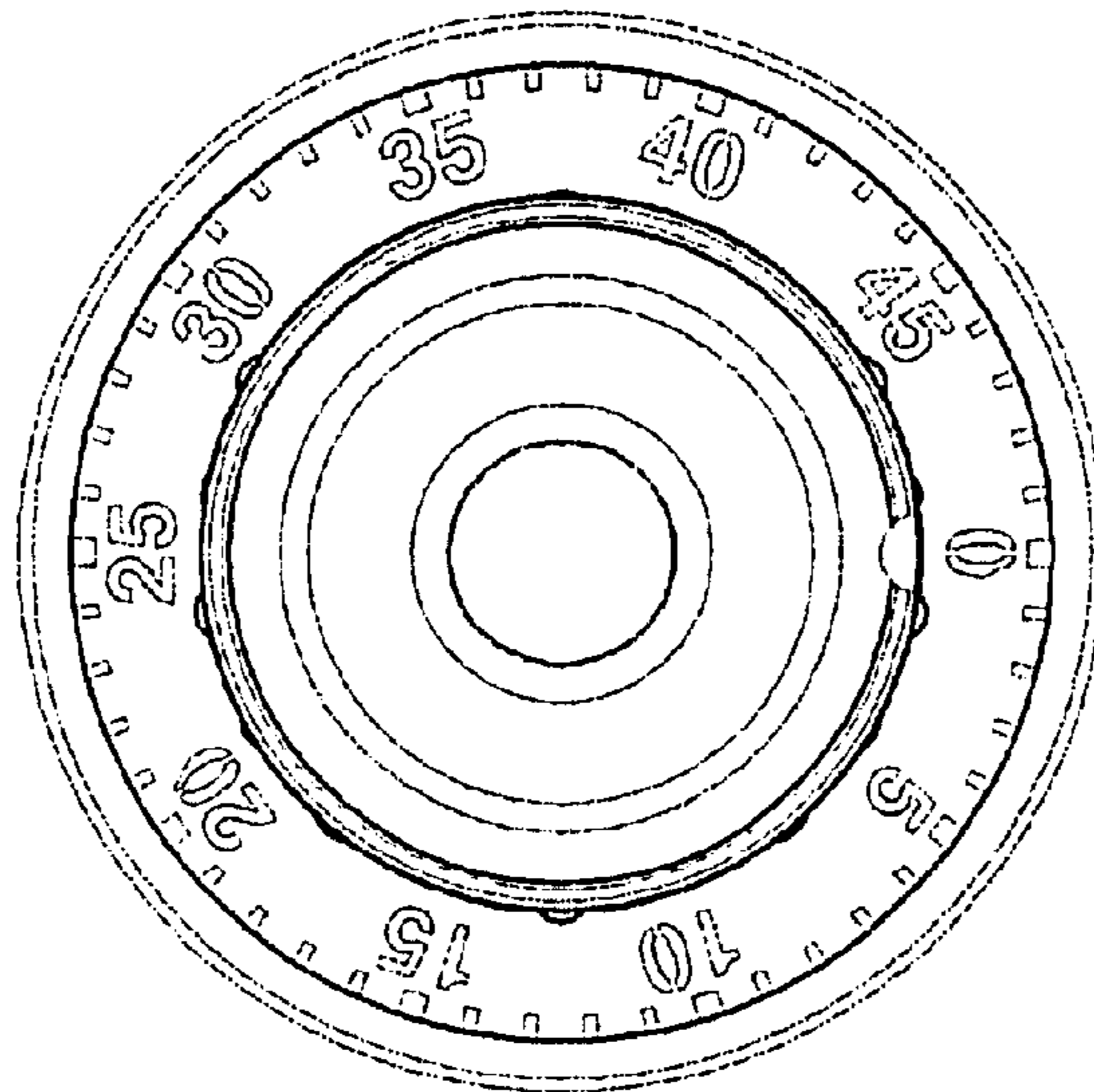

FIG. 18

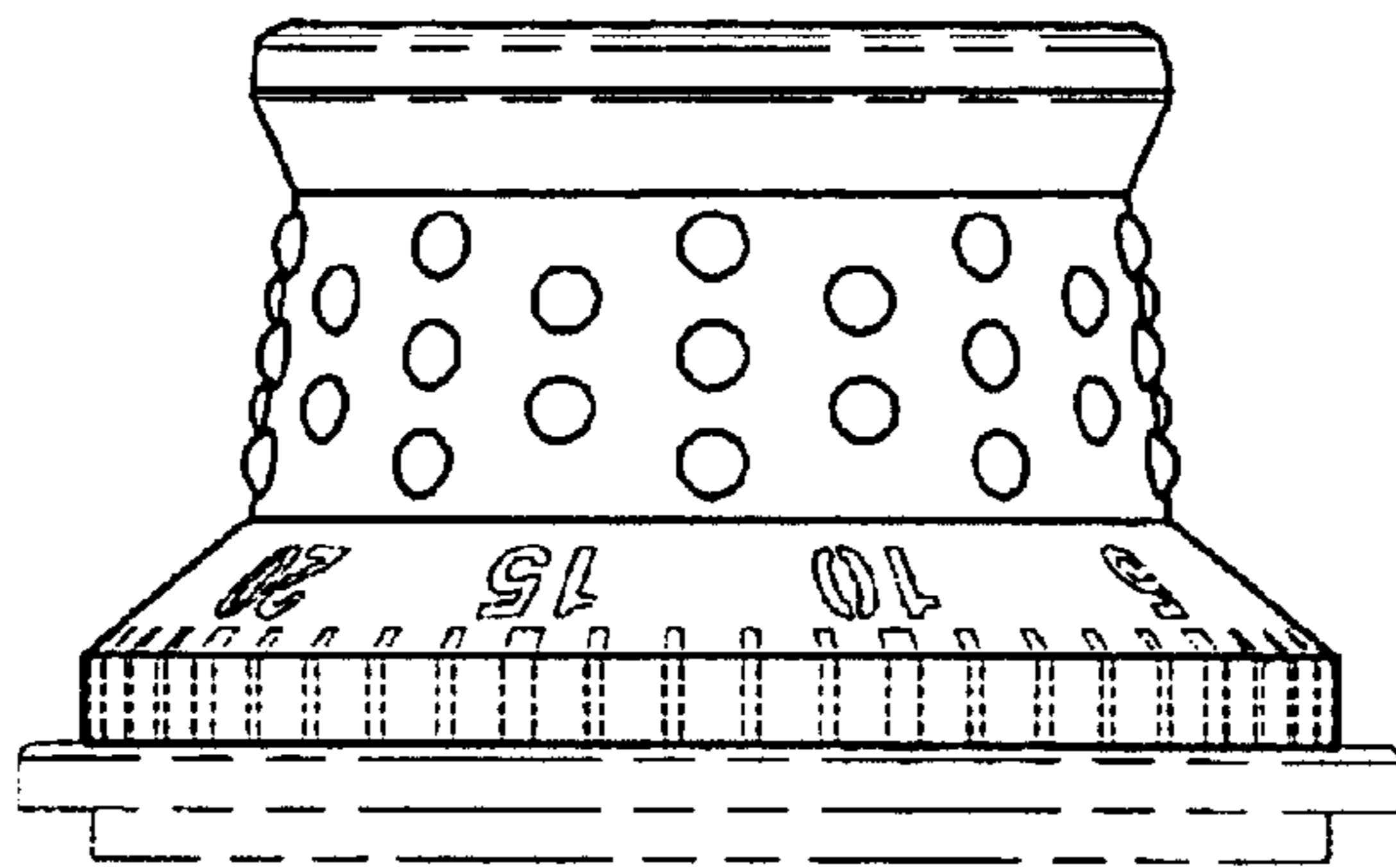

FIG. 19

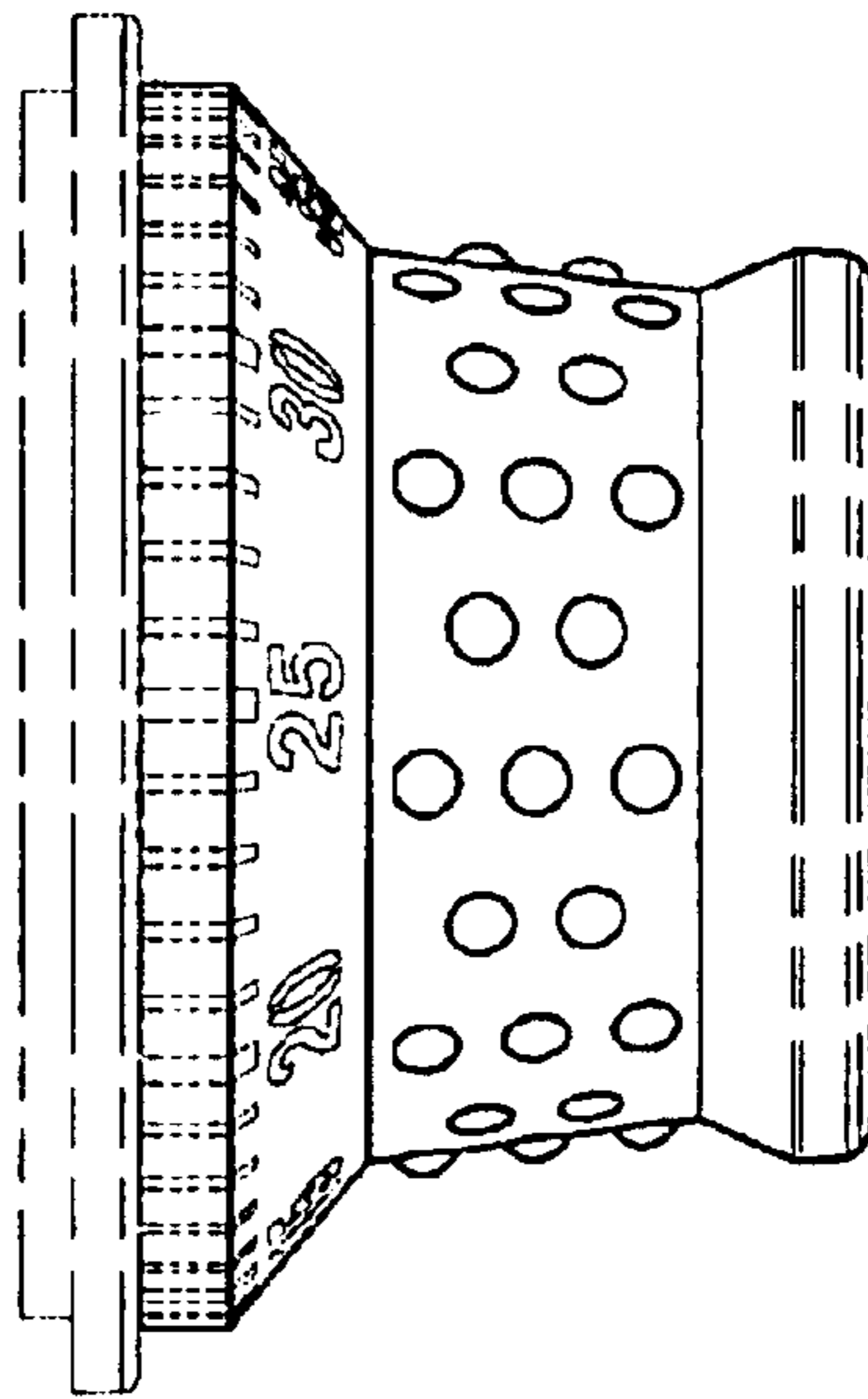

FIG. 20

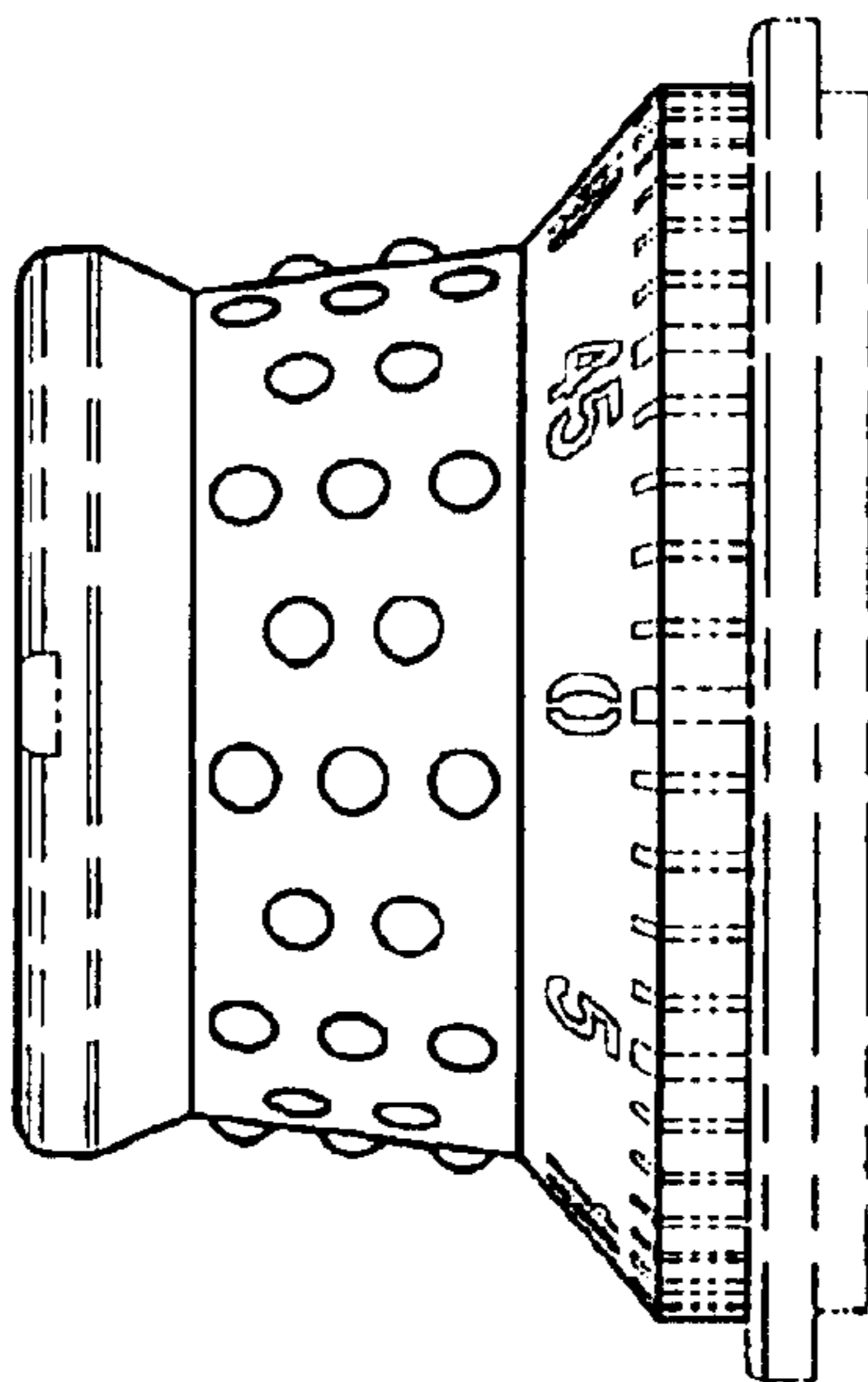

FIG. 21

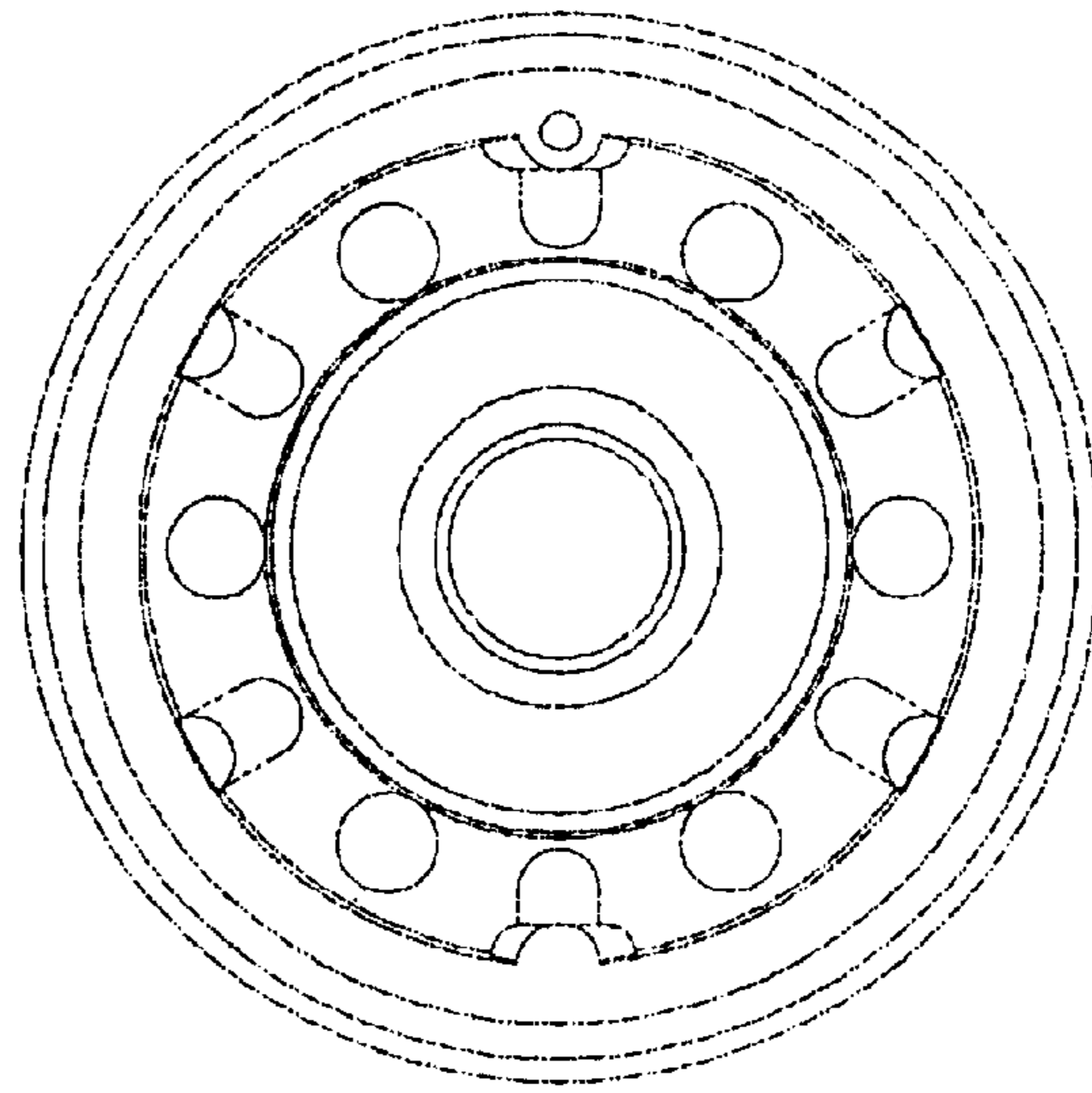

FIG. 22

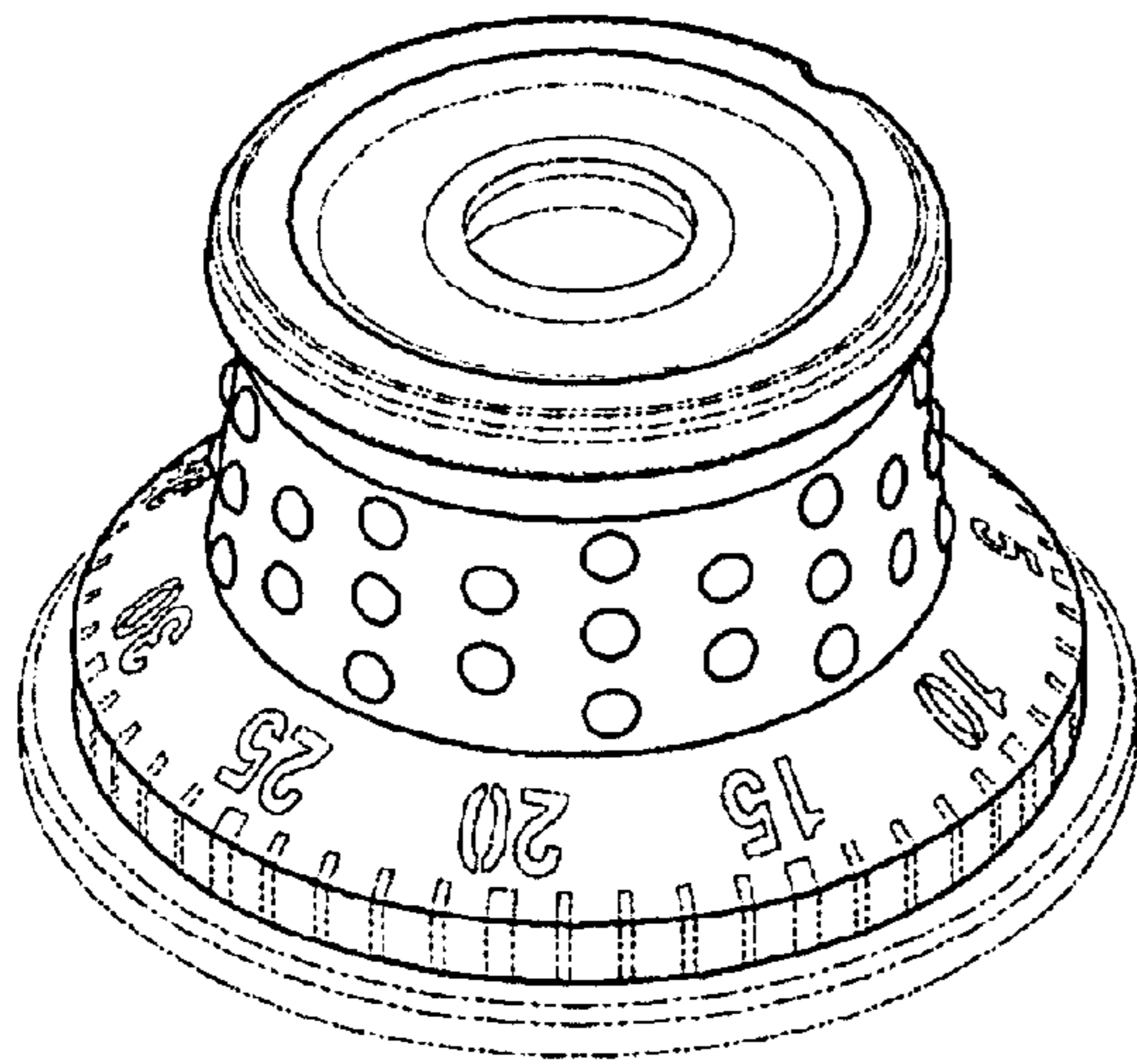

FIG. 23

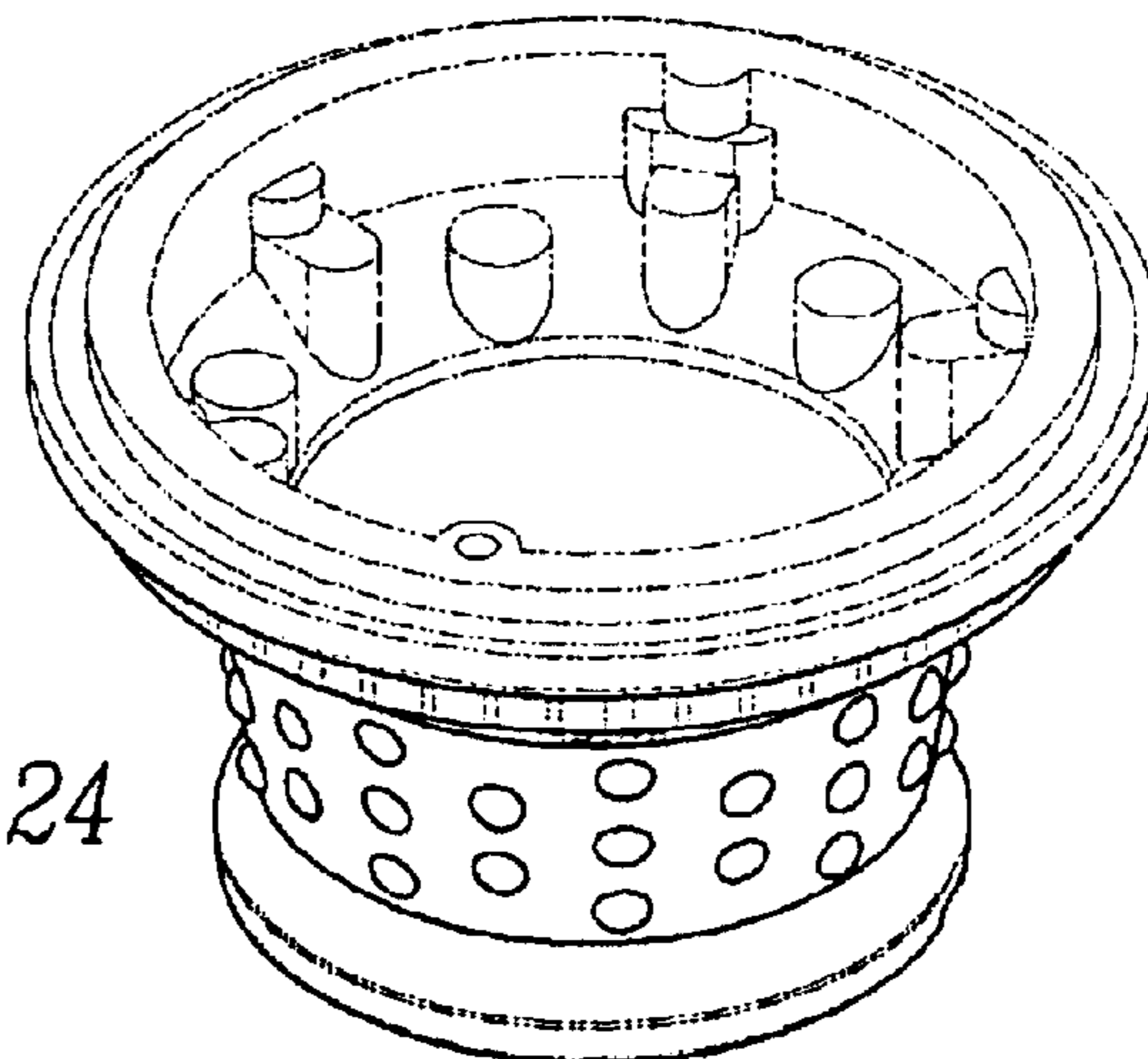

FIG. 24

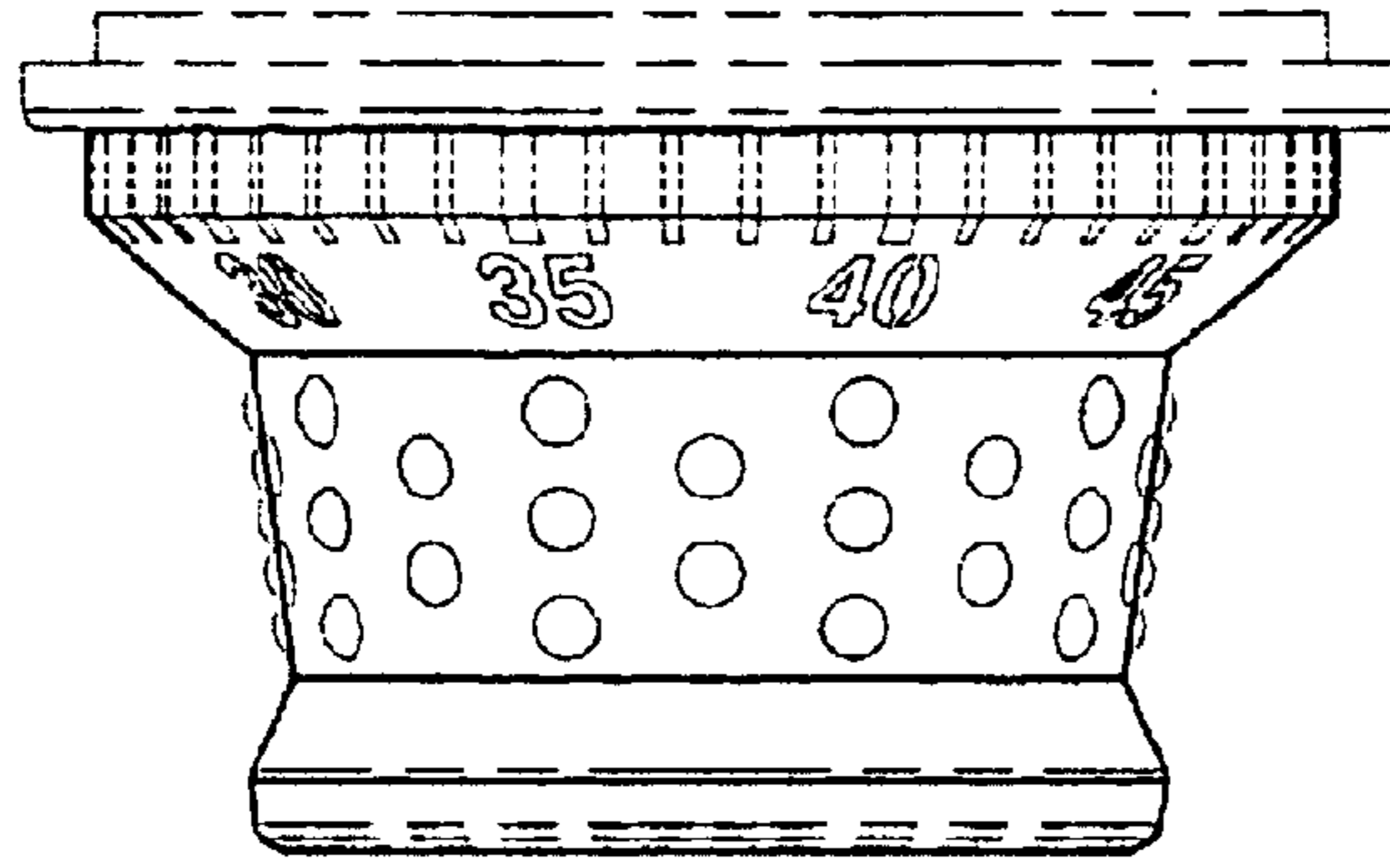

FIG. 25

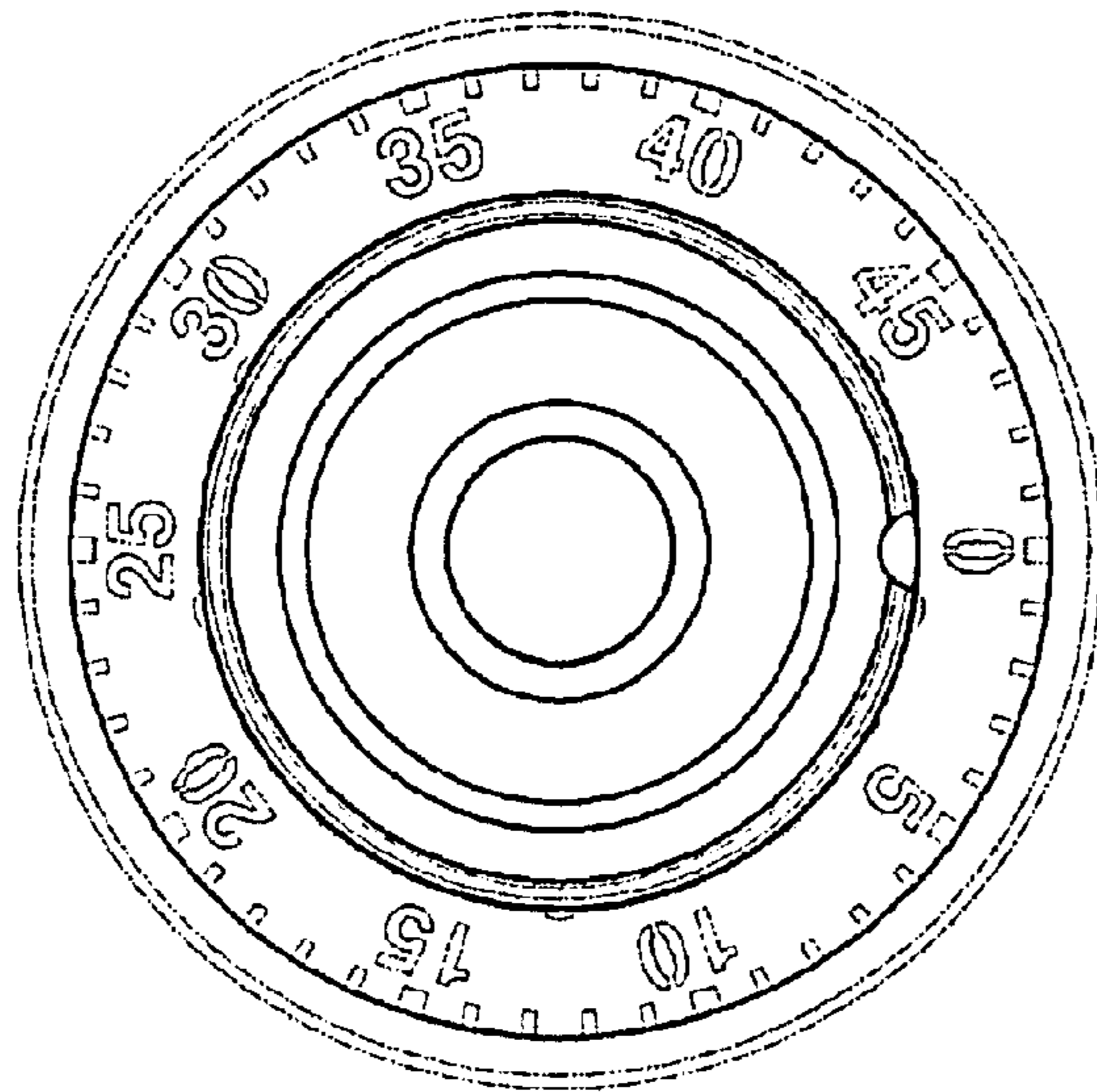

FIG. 26

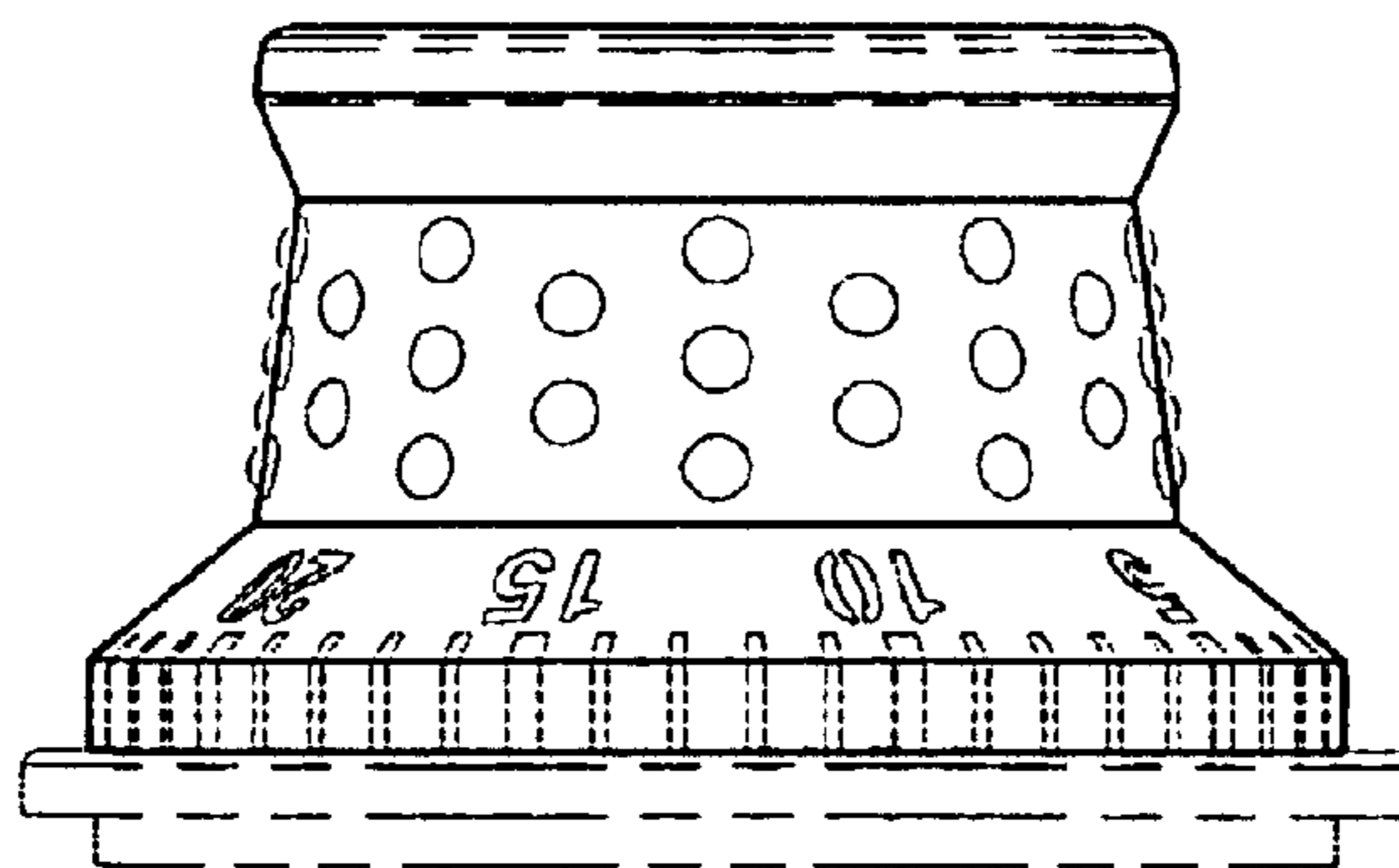

FIG. 27

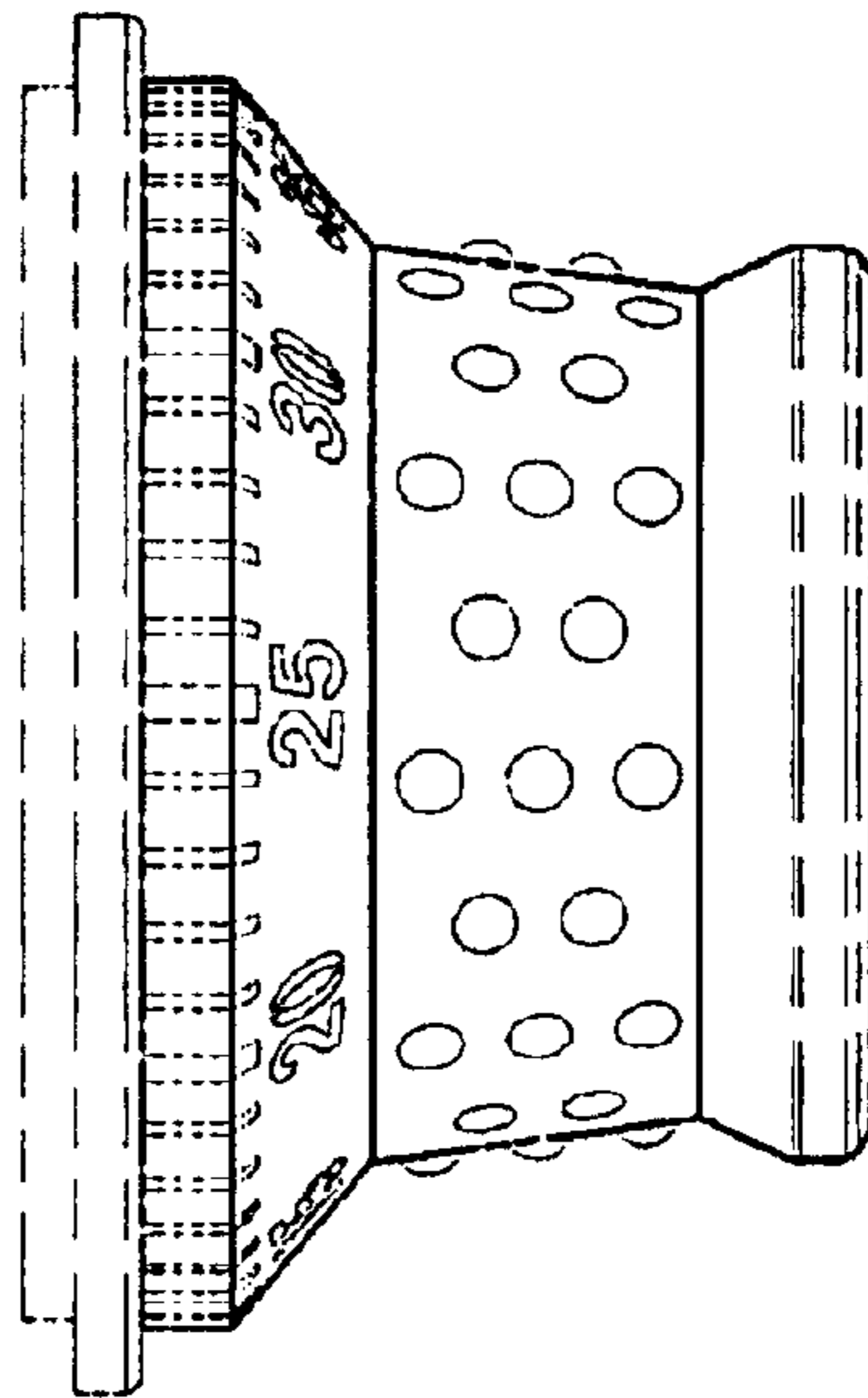

FIG. 28

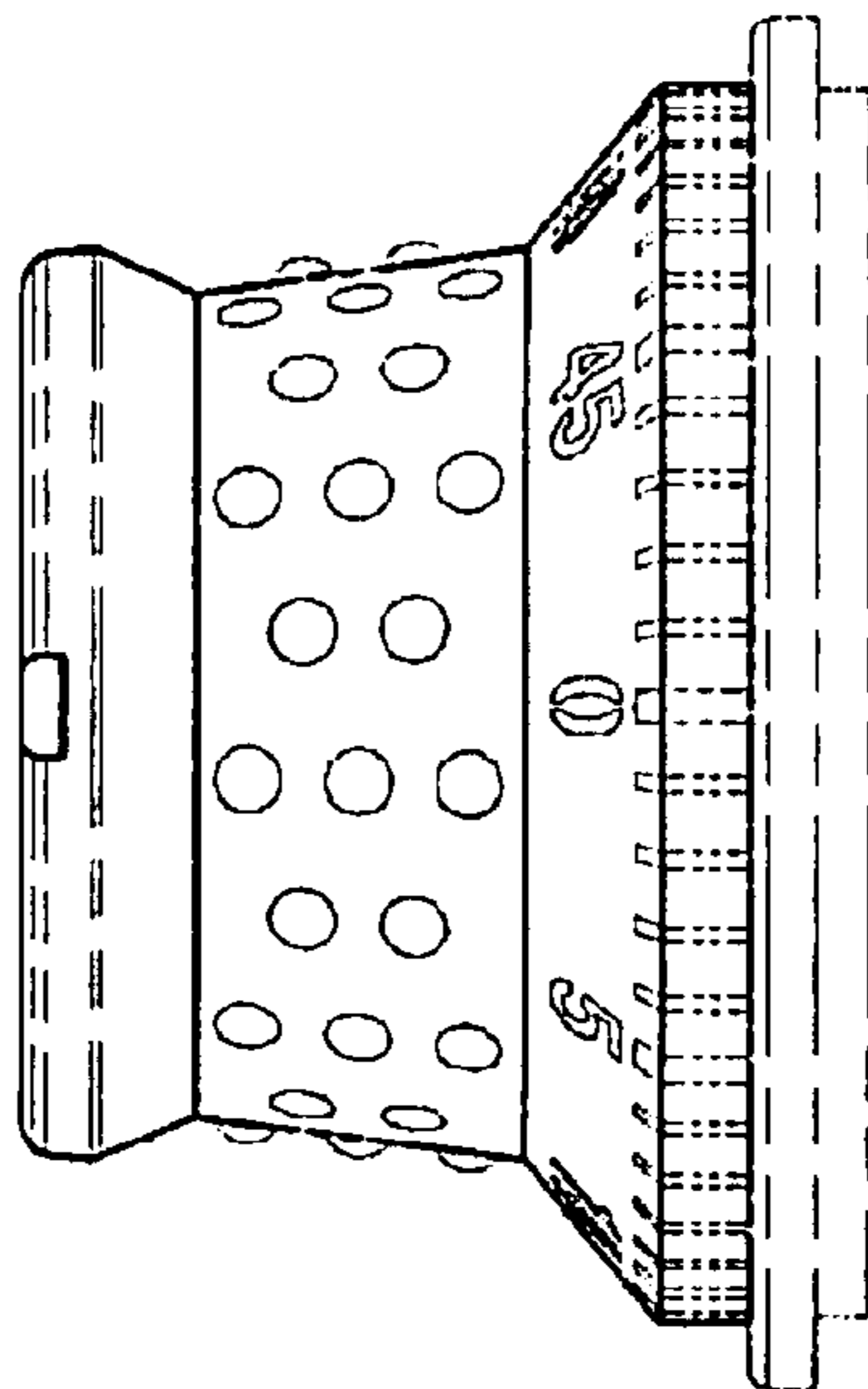

FIG. 29

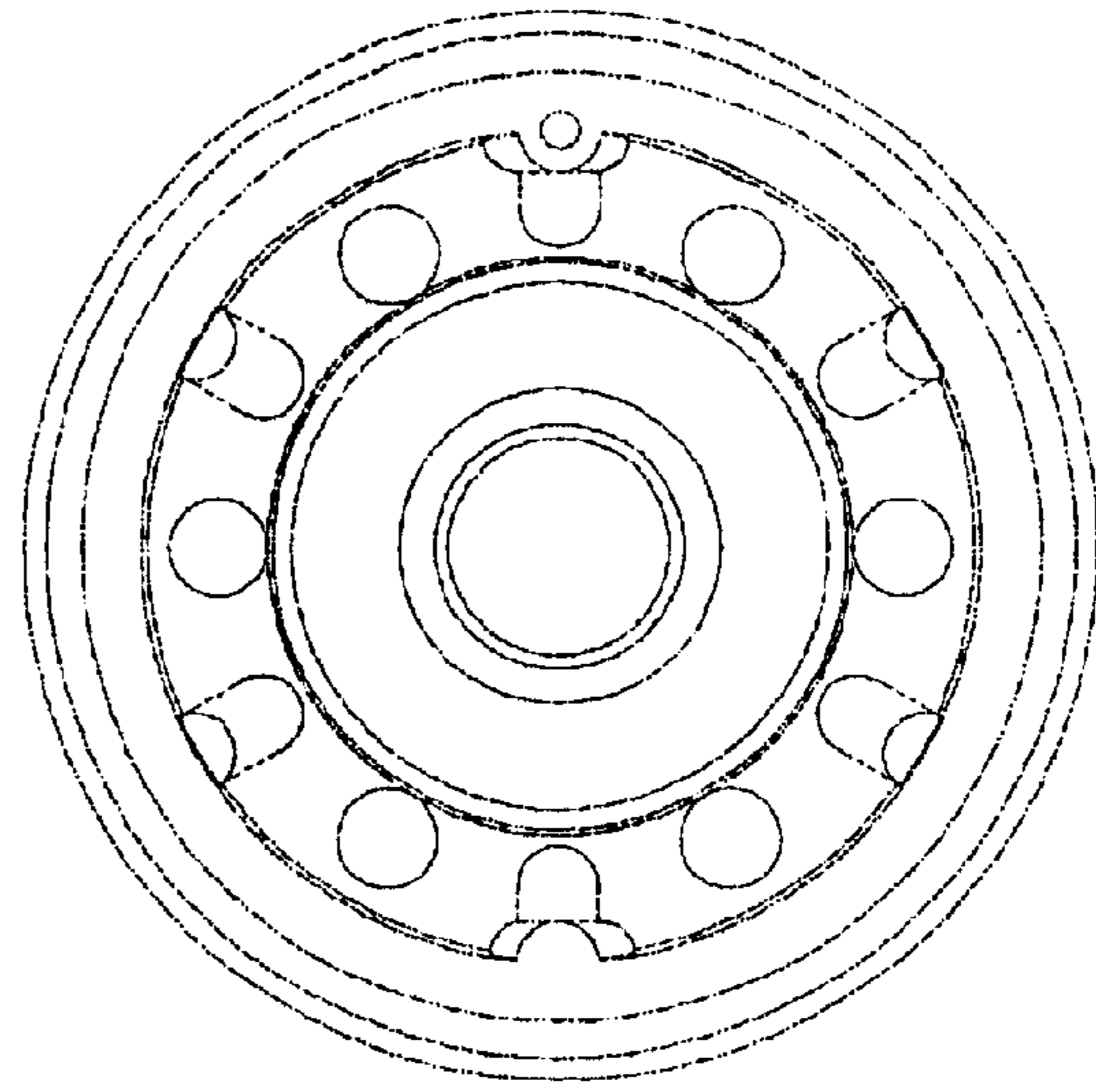

FIG. 30

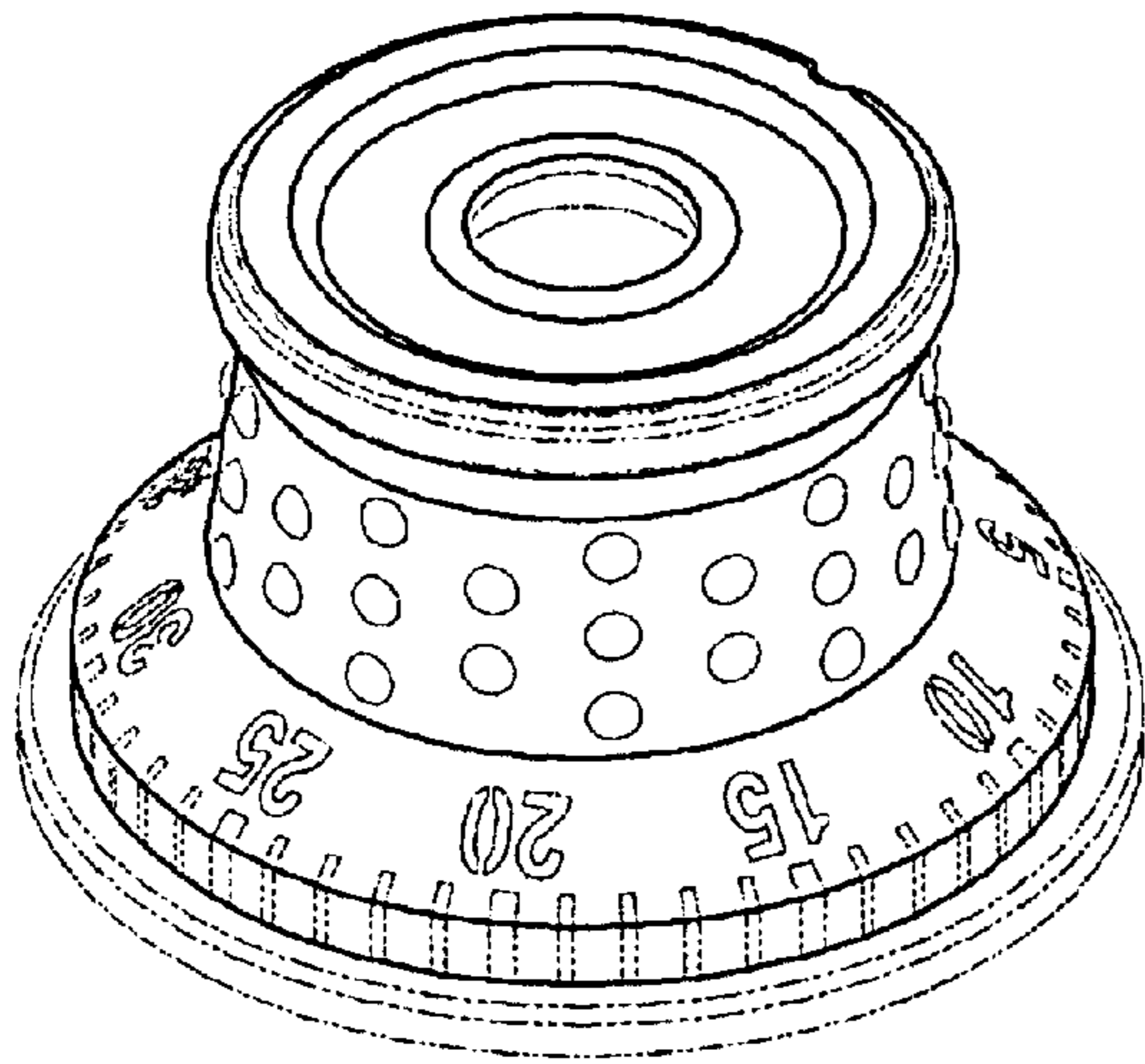

FIG. 31

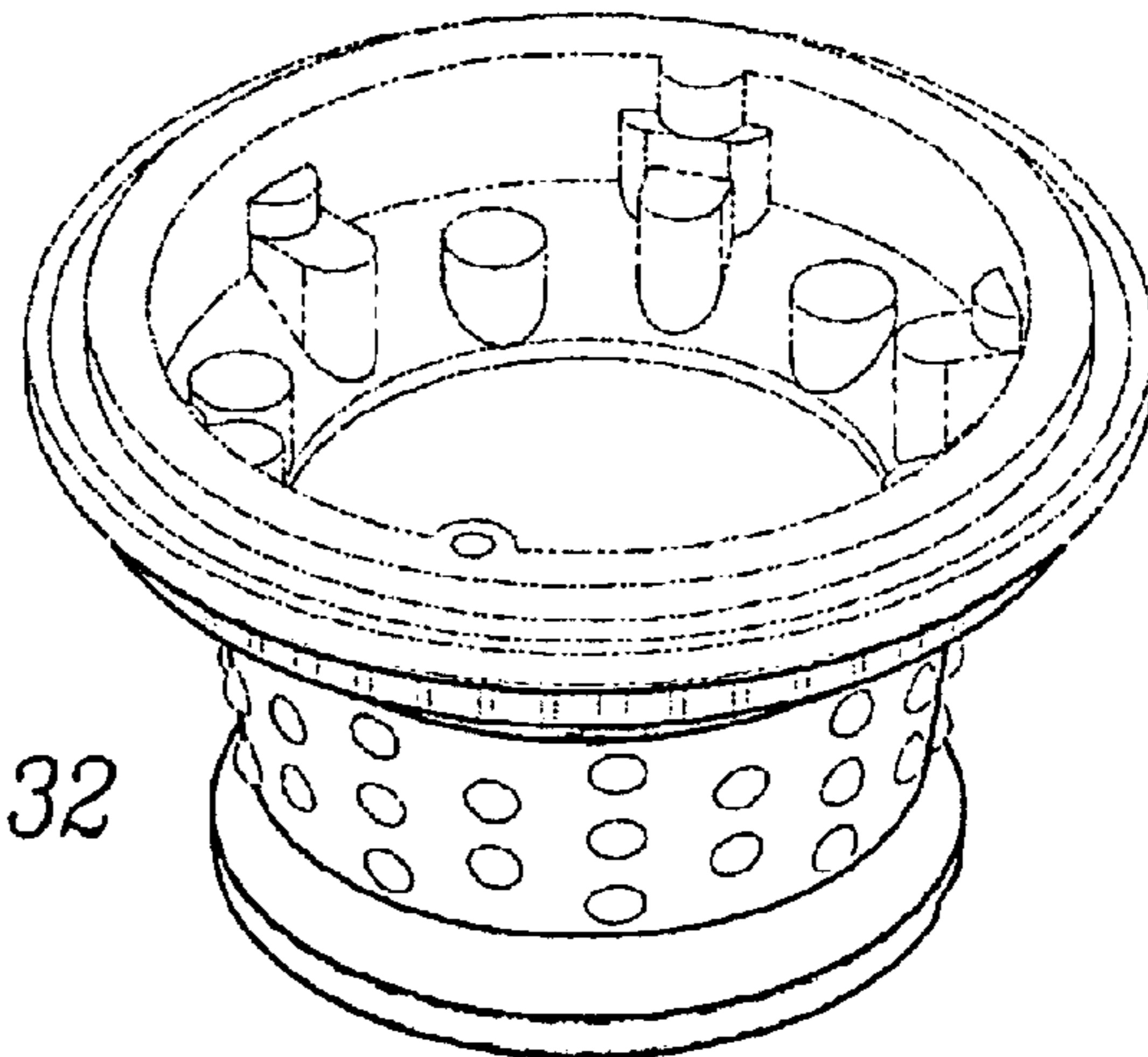

FIG. 32