

US00D500890S

(12) **United States Design Patent**
Muramatsu

(10) **Patent No.: US D500,890 S**
(45) **Date of Patent: ** Jan. 11, 2005**

(54) **ELECTRICAL HAIR CLIPPER**

(75) Inventor: **Etsushi Muramatsu, Yokohama (JP)**

(73) Assignee: **Matsushita Electric Works, Ltd.,
Osaka (JP)**

(**) Term: **14 Years**

(21) Appl. No.: **29/207,874**

(22) Filed: **Jun. 17, 2004**

(30) **Foreign Application Priority Data**

Dec. 25, 2003 (JP) 2003-038372

(51) **LOC (7) Cl. 28-03**

(52) **U.S. Cl. D28/53**

(58) **Field of Search** D28/44, 44.1,
D28/49-54; 30/32, 34.05, 34.1, 41, 41.5-41.6,
43-43.92, 195, 201, 208, 210, 526

(56) **References Cited**

U.S. PATENT DOCUMENTS

D456,947 S * 5/2002 Hoffman et al. D28/53
D458,411 S * 6/2002 Abraham et al. D28/53
D479,363 S * 9/2003 Micinilio D28/53

2003/0029042 A1 * 2/2003 Wilcox 30/34.1

* cited by examiner

Primary Examiner—Jennifer Rivard

(74) *Attorney, Agent, or Firm*—J.C. Patents

(57) **CLAIM**

The ornamental design for an electrical hair clipper, as shown and described.

DESCRIPTION

FIG. 1 is a top, front and right side perspective view of an electrical hair clipper showing the new design.

FIG. 2 is a front elevational view thereof.

FIG. 3 is a rear elevational view thereof.

FIG. 4 is a left side elevational view thereof.

FIG. 5 is a right side elevational view thereof.

FIG. 6 is a top plan view thereof.

FIG. 7 is a bottom plan view thereof.

FIG. 8 is a right side sectional view thereof, taken along line 8—8 of FIG. 2 and omitting the interior construction.

FIG. 9 is a top sectional view thereof, taken along line 9—9 of FIG. 2 and omitting the interior construction; and,

FIG. 10 is a top sectional view thereof, taken along line 10—10 of FIG. 2 and omitting the interior construction.

1 Claim, 8 Drawing Sheets

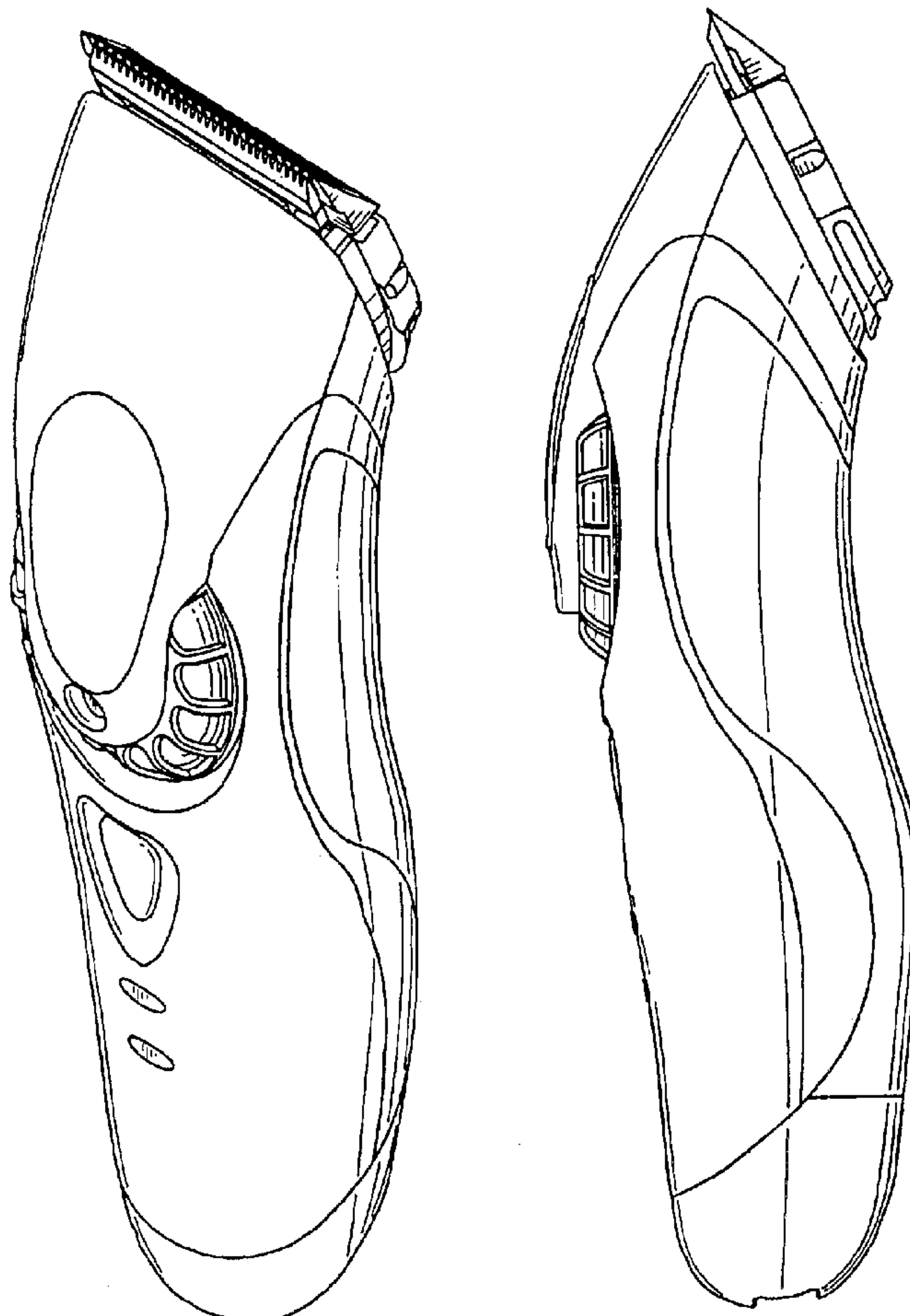

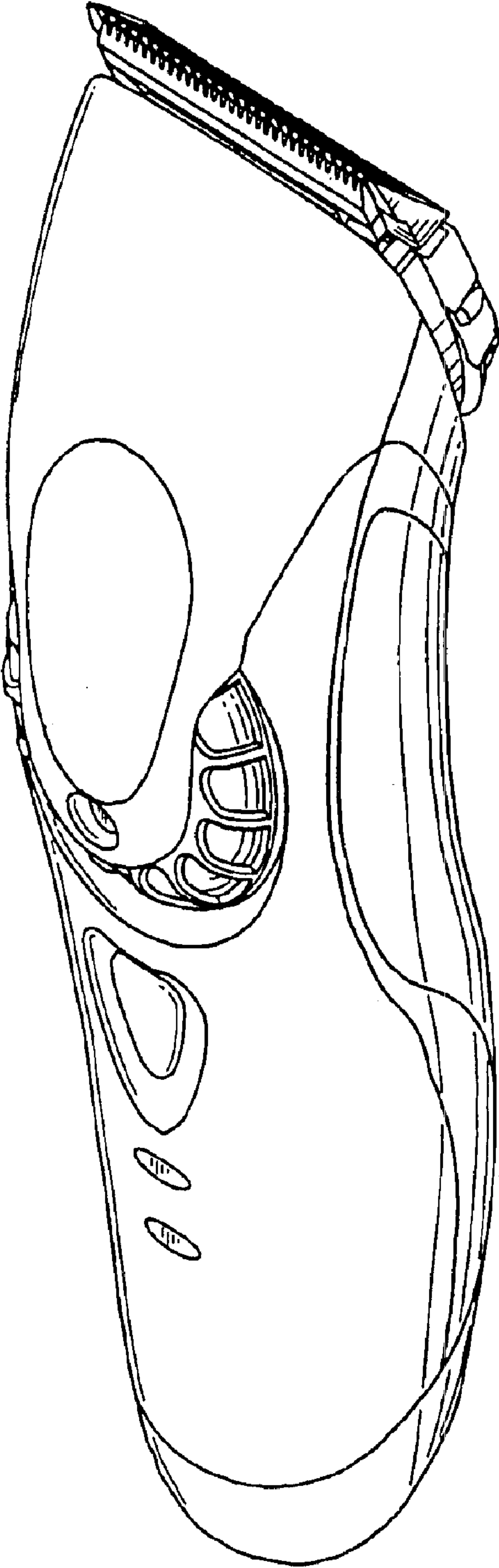

FIG. 1

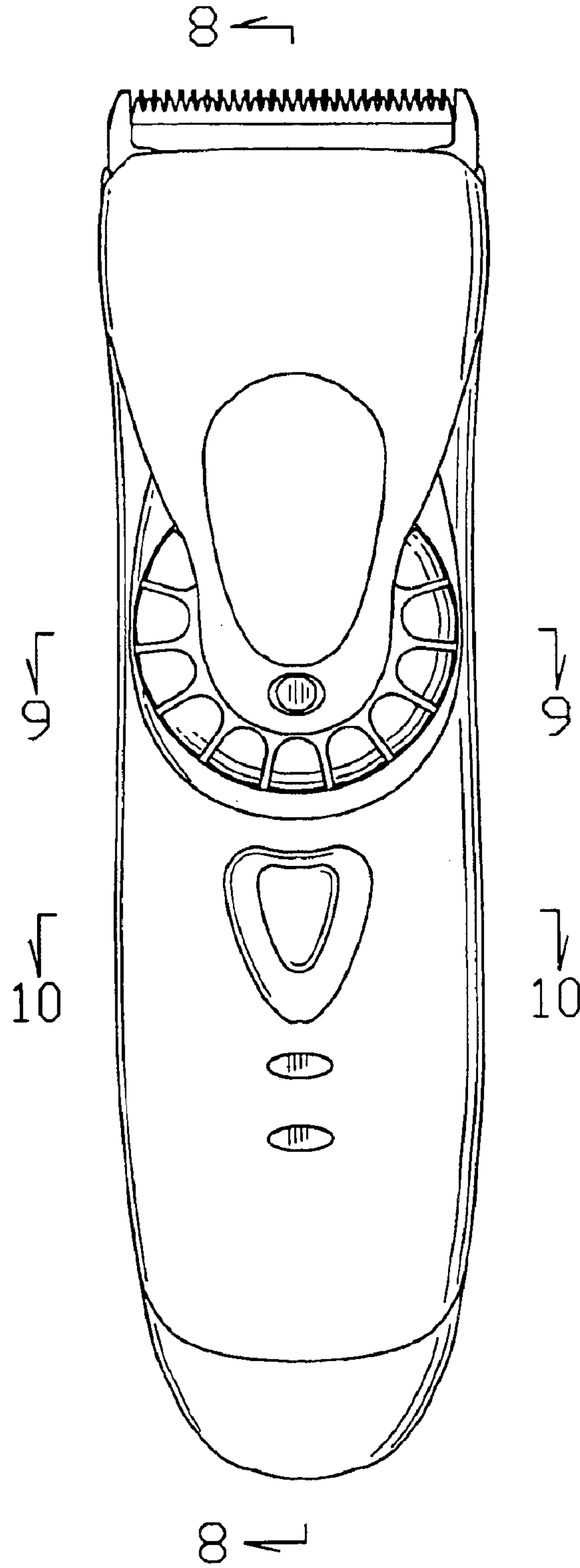

FIG. 2

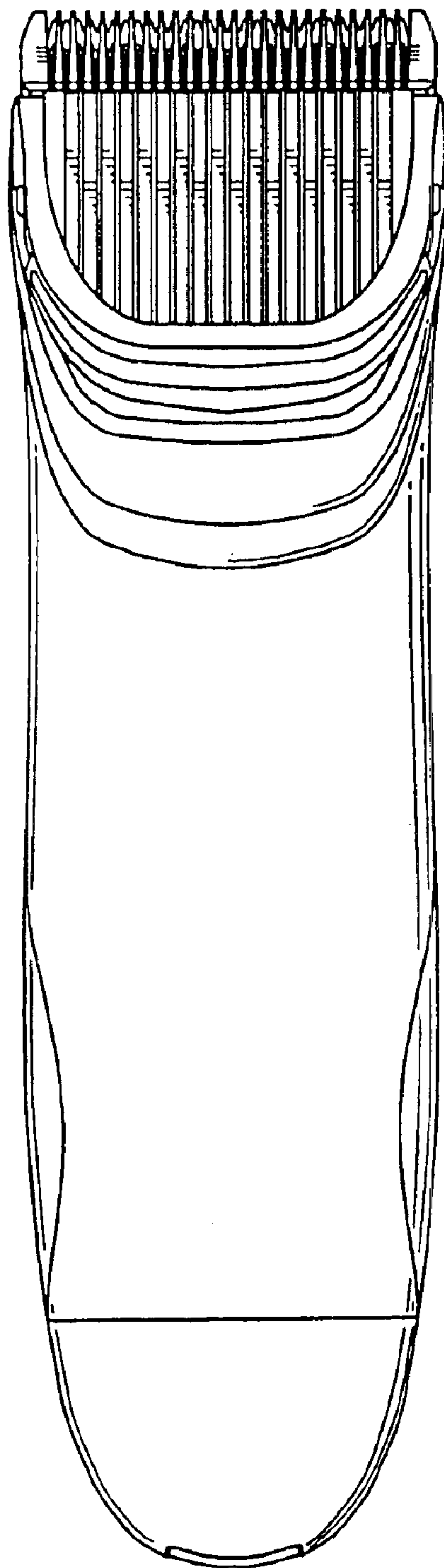

FIG. 3

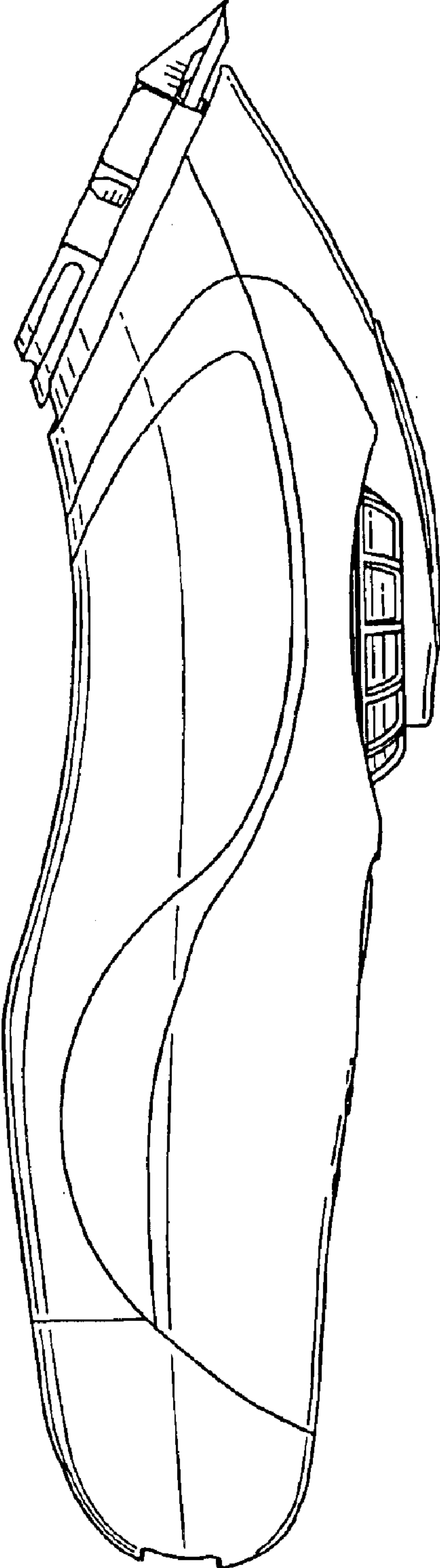

FIG. 4

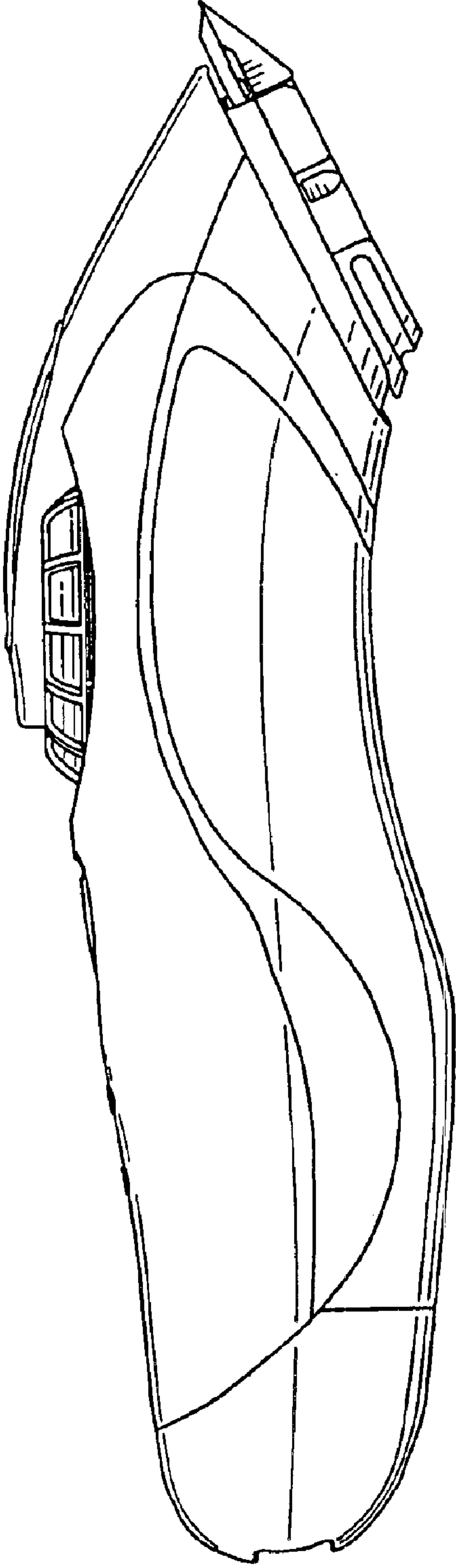

FIG. 5

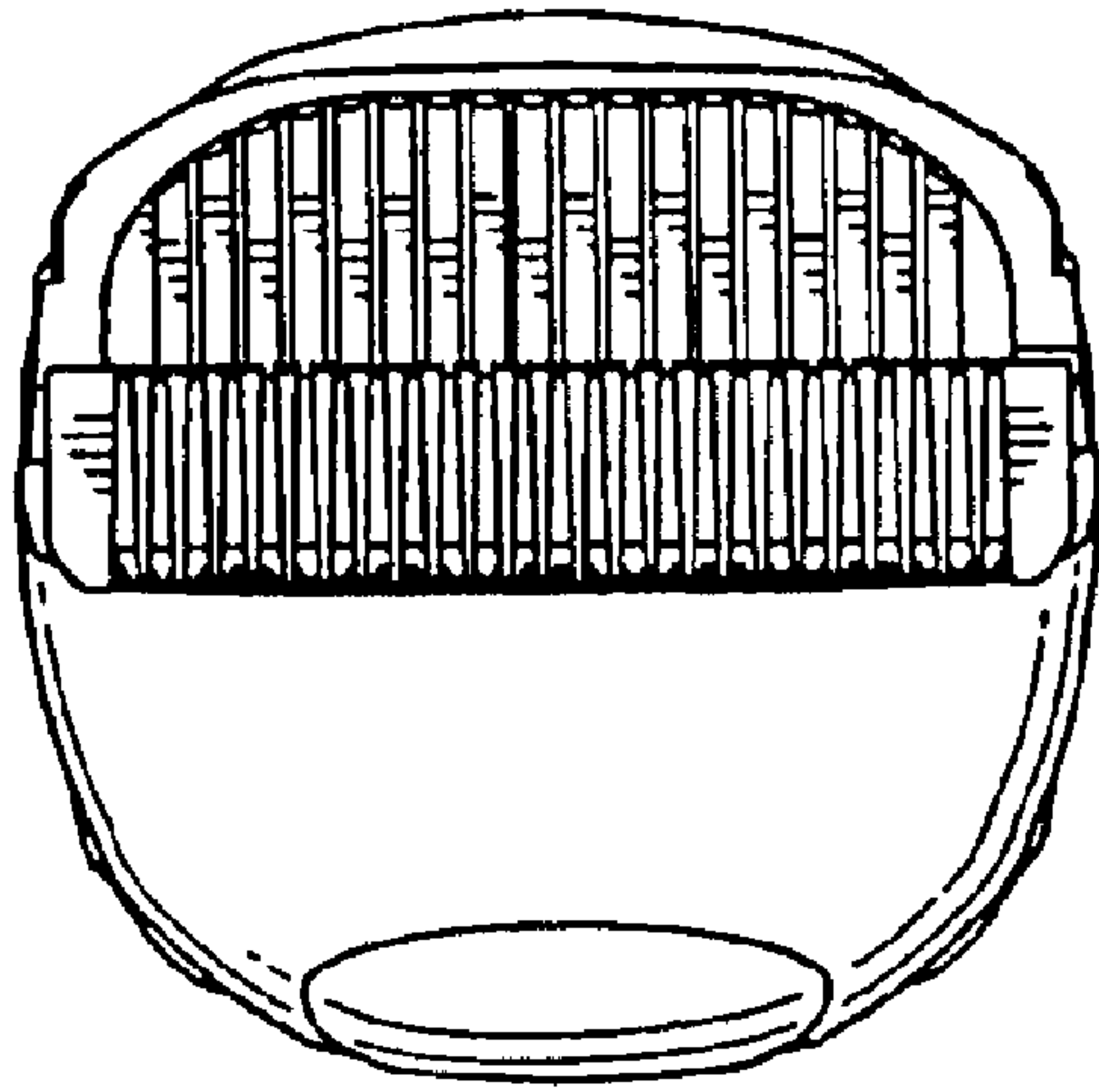

FIG. 6

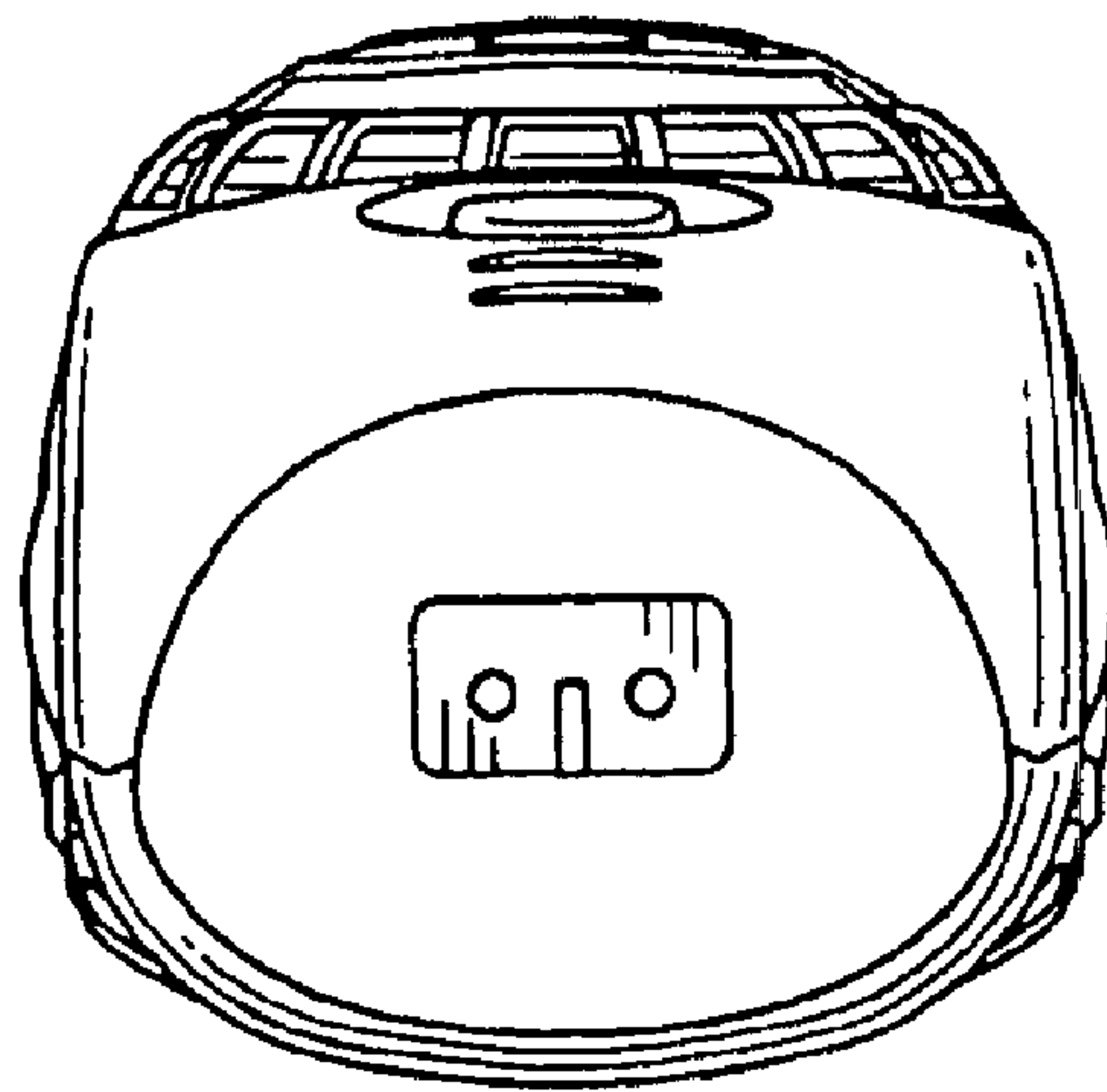

FIG. 7

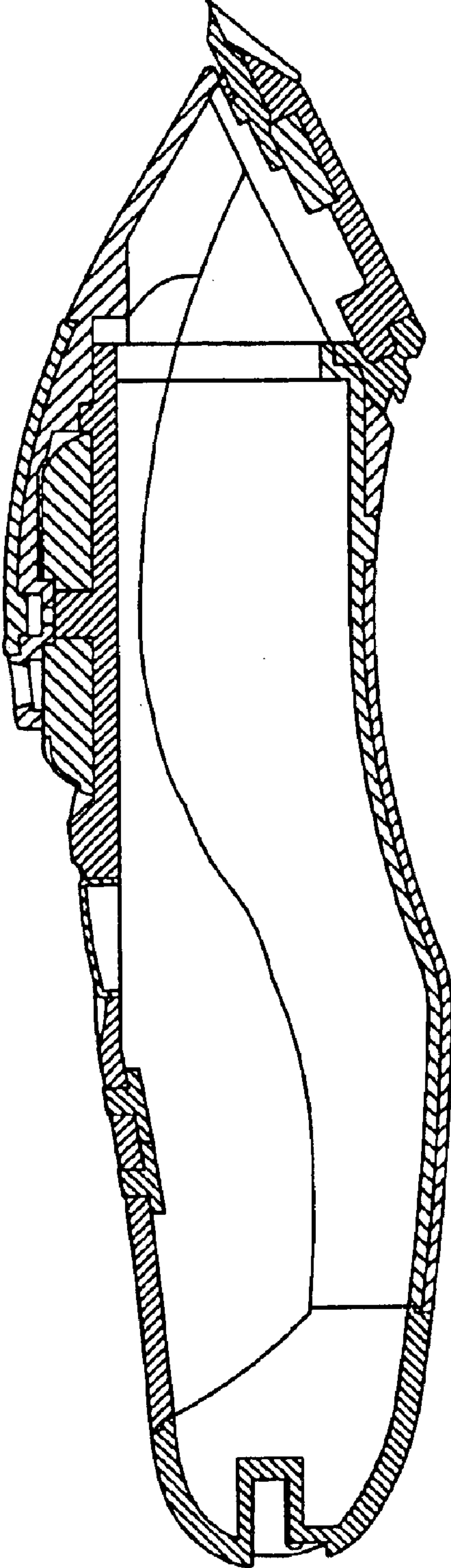

FIG. 8

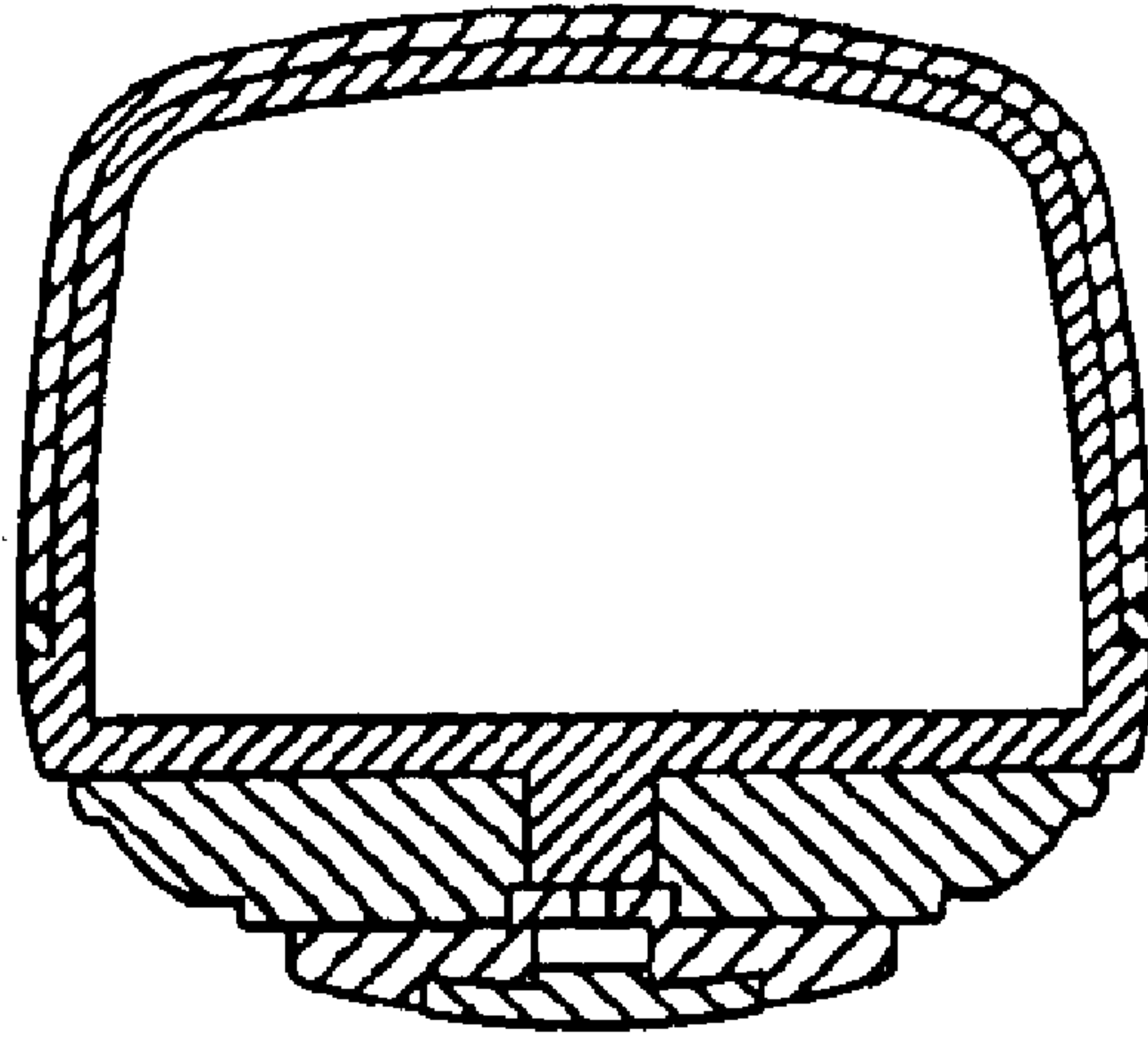

FIG. 9

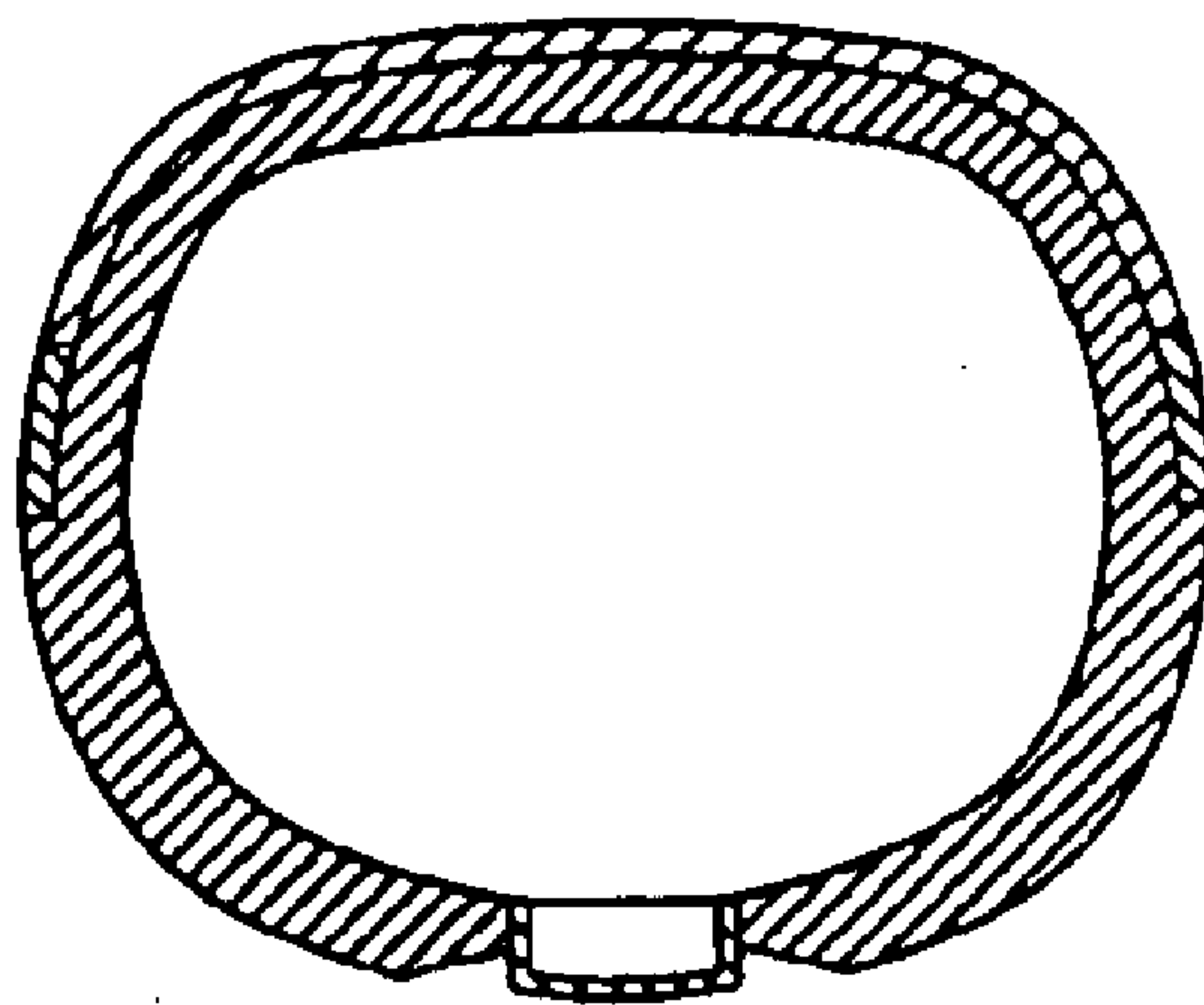

FIG. 10