

US00D500704S

(12) **United States Design Patent**  
**Kruse et al.**

(10) **Patent No.:** **US D500,704 S**  
(45) **Date of Patent:** **\*\* Jan. 11, 2005**

(54) **PLANTER**

D395,411 S \* 6/1998 Grebert ..... D11/153  
5,870,856 A 2/1999 Friend  
5,878,945 A 3/1999 Weder

(76) Inventors: **Gordon H. Kruse**, 1430 110th St.  
North, Canby, MN (US) 56220; **Susan**  
**A. Kruse**, 1430 110th St. North, Canby,  
MN (US) 56220

\* cited by examiner

*Primary Examiner*—Mimosa De  
(74) *Attorney, Agent, or Firm*—Richard C. Litman

(\*\*) **Term:** **14 Years**

(57) **CLAIM**

(21) Appl. No.: **29/205,413**

The ornamental design for a planter, as shown and described.

(22) Filed: **May 14, 2004**

(51) **LOC (7) Cl.** ..... **11-02**

**DESCRIPTION**

(52) **U.S. Cl.** ..... **D11/148; D11/143**

(58) **Field of Search** ..... D11/143, 144,  
D11/148, 149, 151-154; 47/39, 40, 41.01,  
65.5, 65.7, 66.6, 67, 68; 248/27.8; 206/423;  
217/122, 125

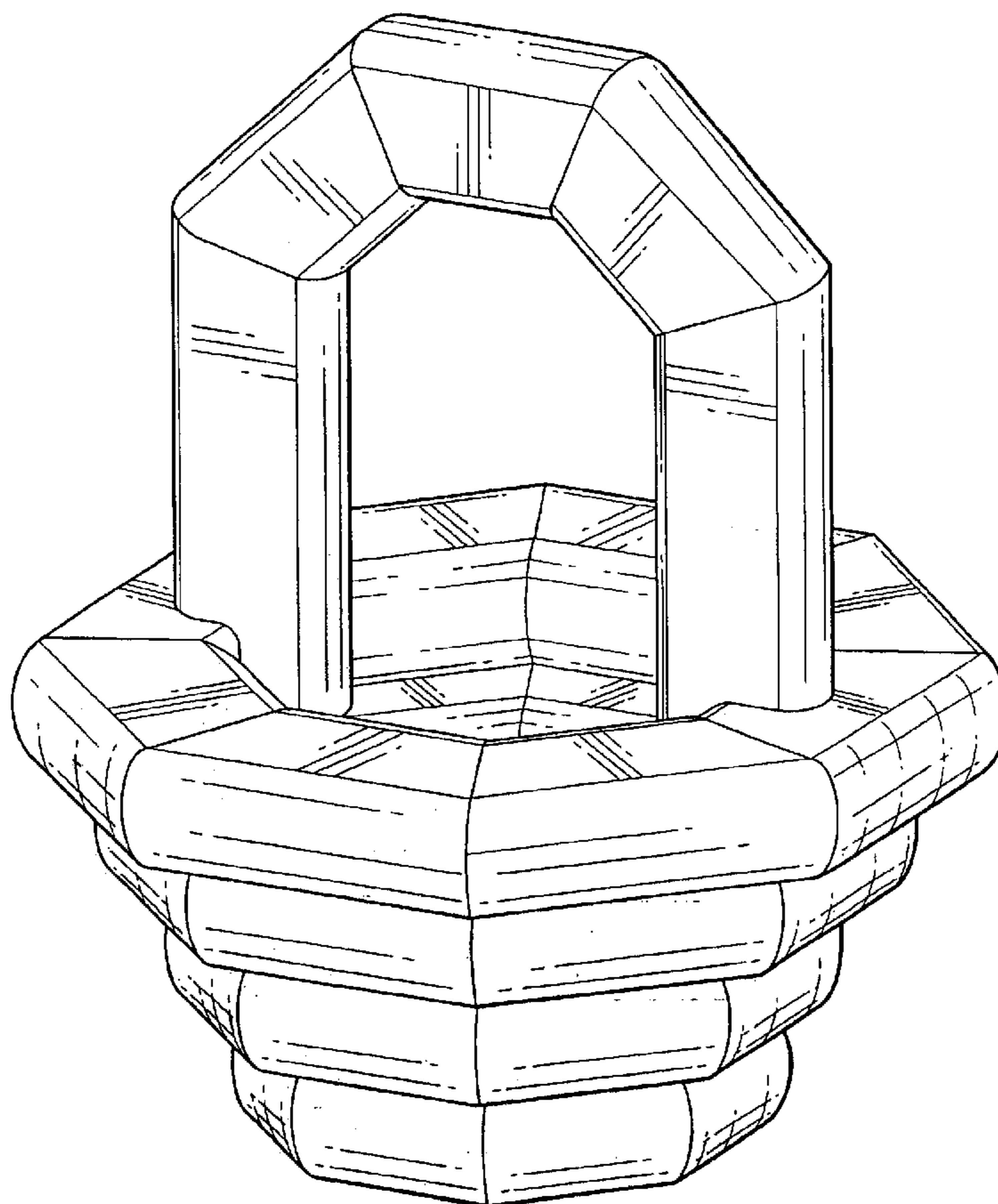
FIG. 1 is a perspective view of a planter showing my new design;  
FIG. 2 is a front elevational view, with the rear view being a mirror image, thereof;  
FIG. 3 is a right side elevational view with the left side being a mirror image thereof;  
FIG. 4 is a bottom plan view thereof;  
FIG. 5 is a top plan view image thereof; and,  
FIG. 6 is an environmental perspective view thereof.  
The broken line showing of the plant in FIG. 6 is for illustrative purposes only and forms no part of the claimed design.

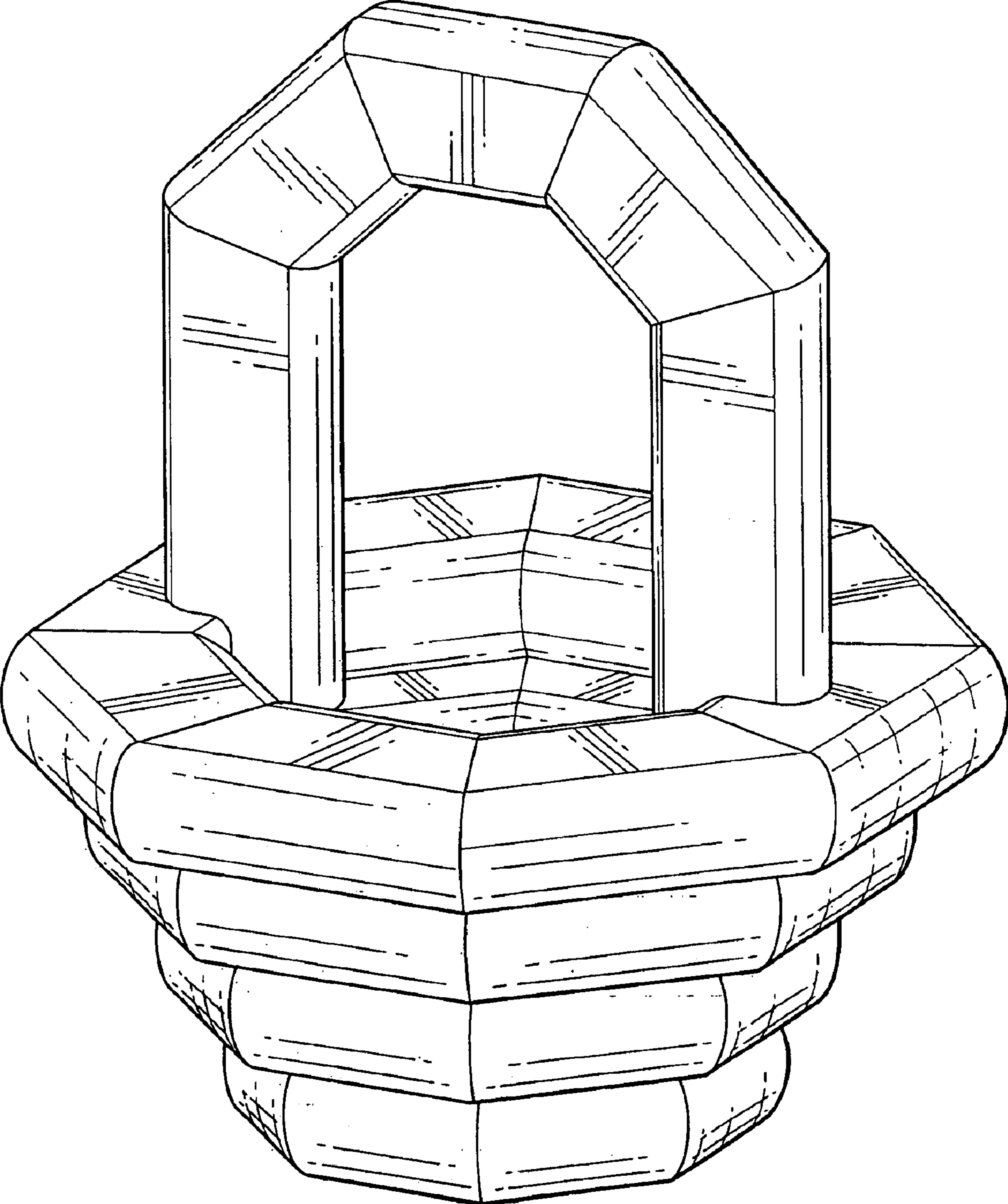
(56) **References Cited**

**U.S. PATENT DOCUMENTS**

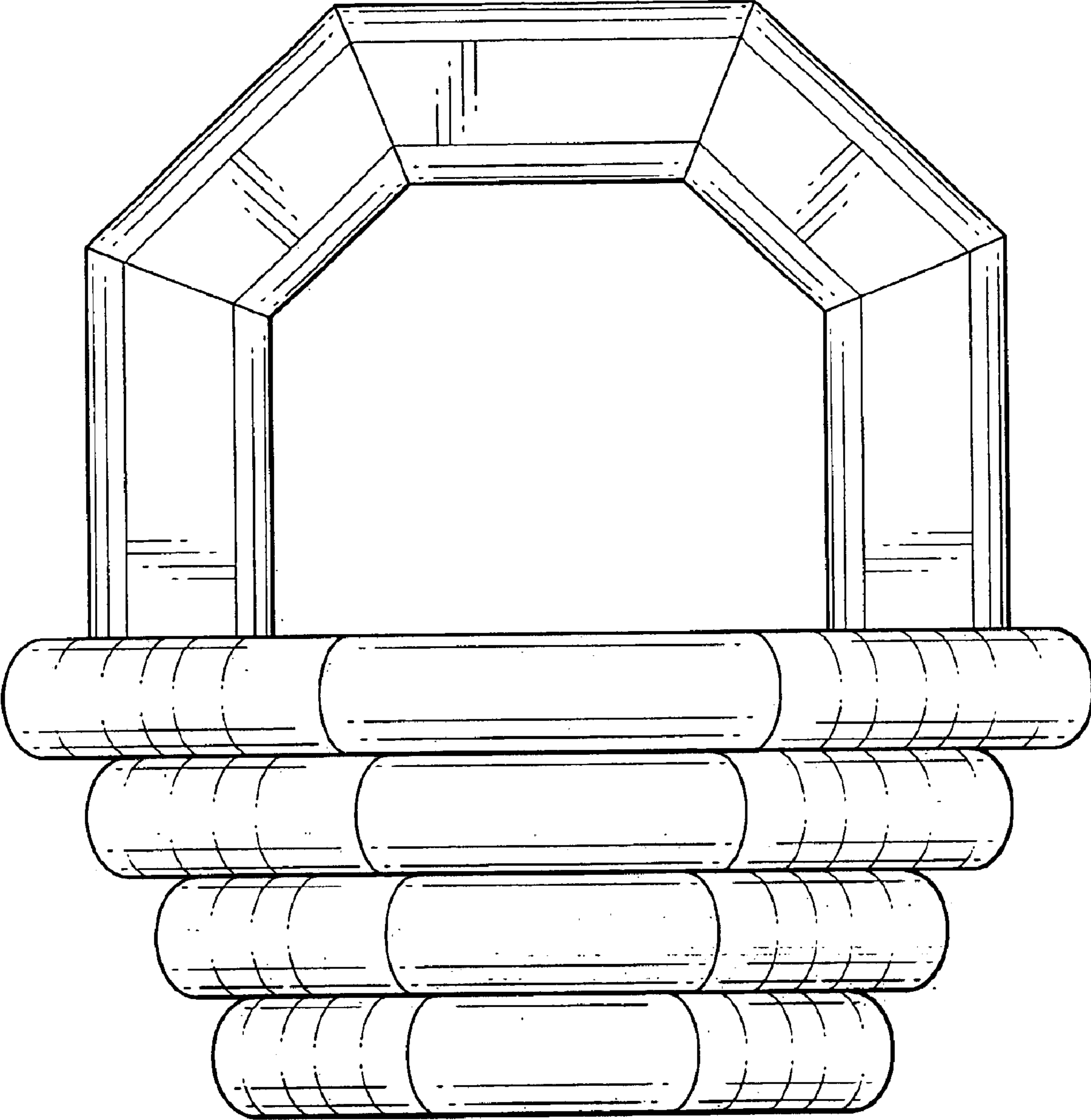
D47,739 S \* 8/1915 Sanford ..... D11/148  
D104,524 S \* 5/1937 Bottome ..... D11/153  
D208,645 S \* 9/1967 Kiggins ..... D11/143  
4,091,928 A 5/1978 Bernardo  
D310,643 S \* 9/1990 Morando ..... D11/149  
D319,199 S \* 8/1991 Lomeli ..... D11/153

**1 Claim, 6 Drawing Sheets**

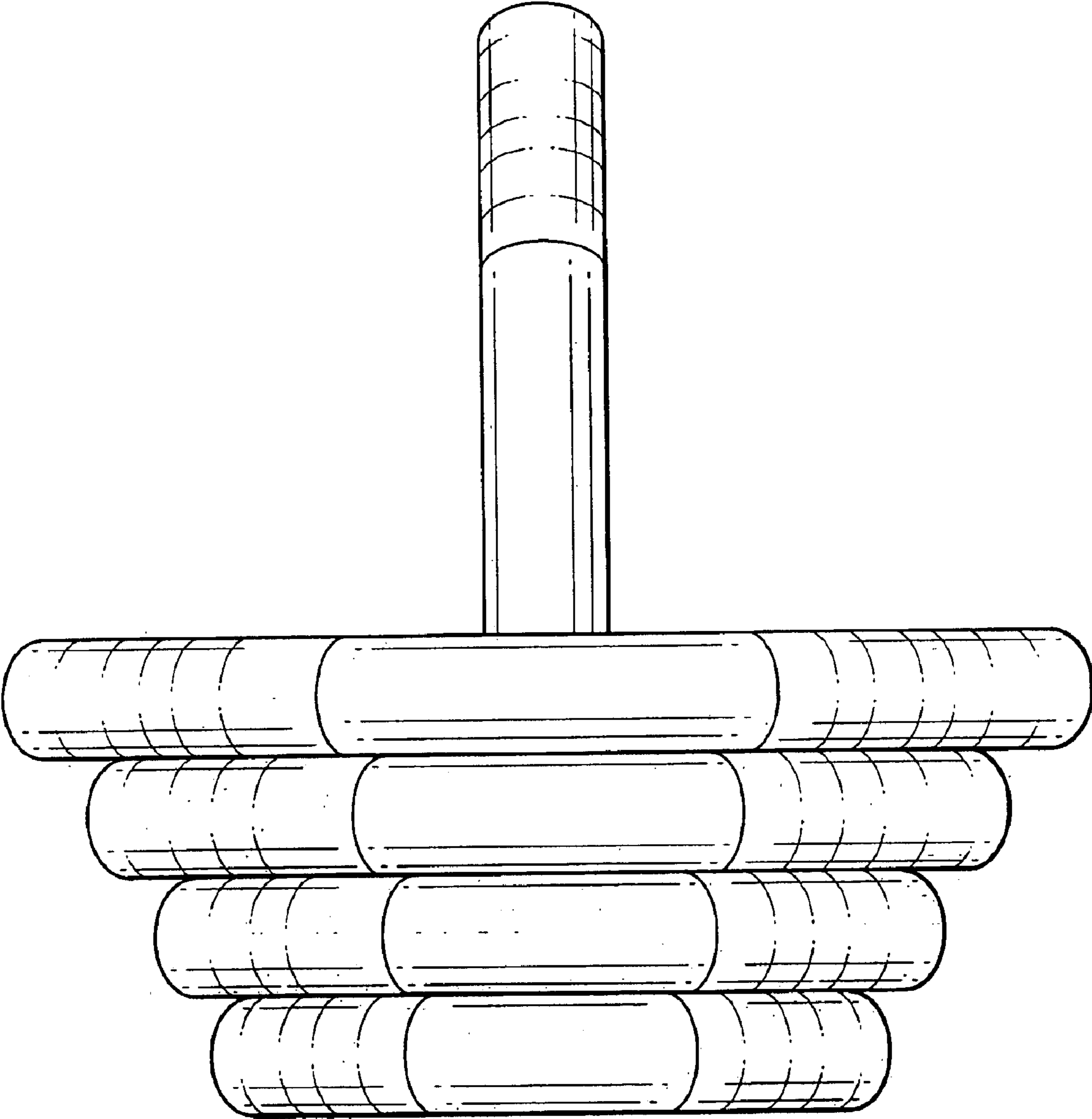




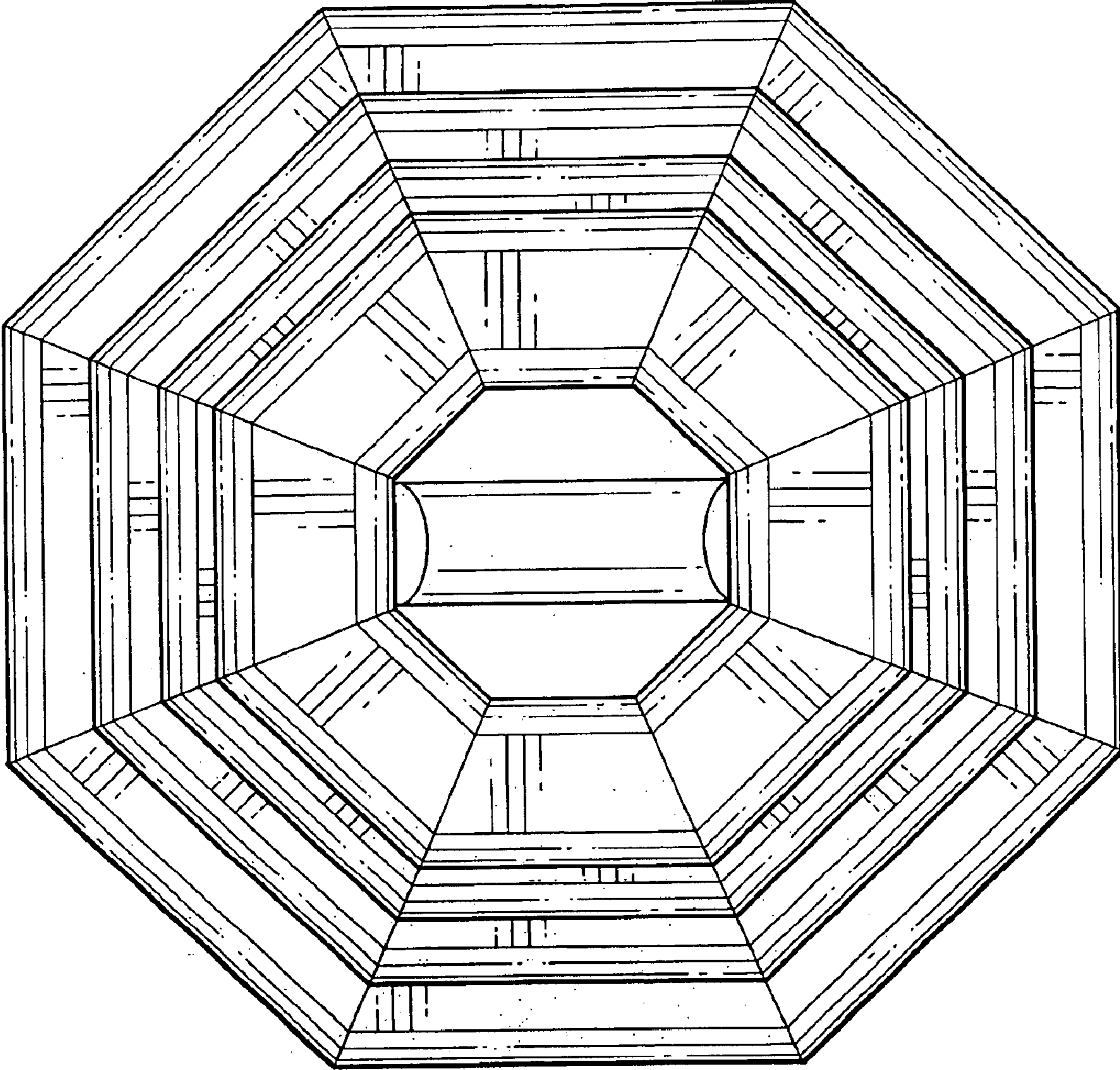
**FIG. 1**



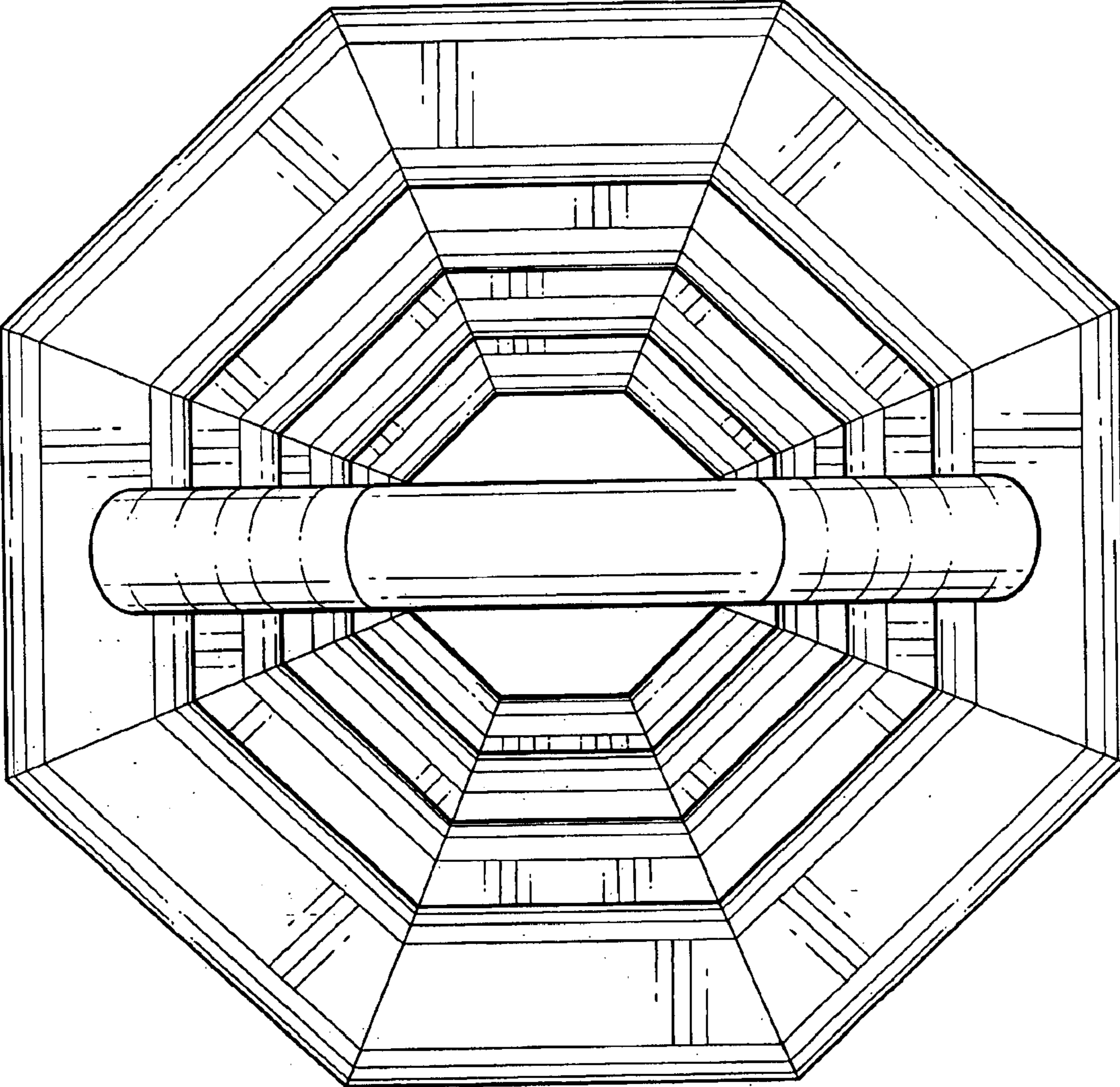
**FIG. 2**



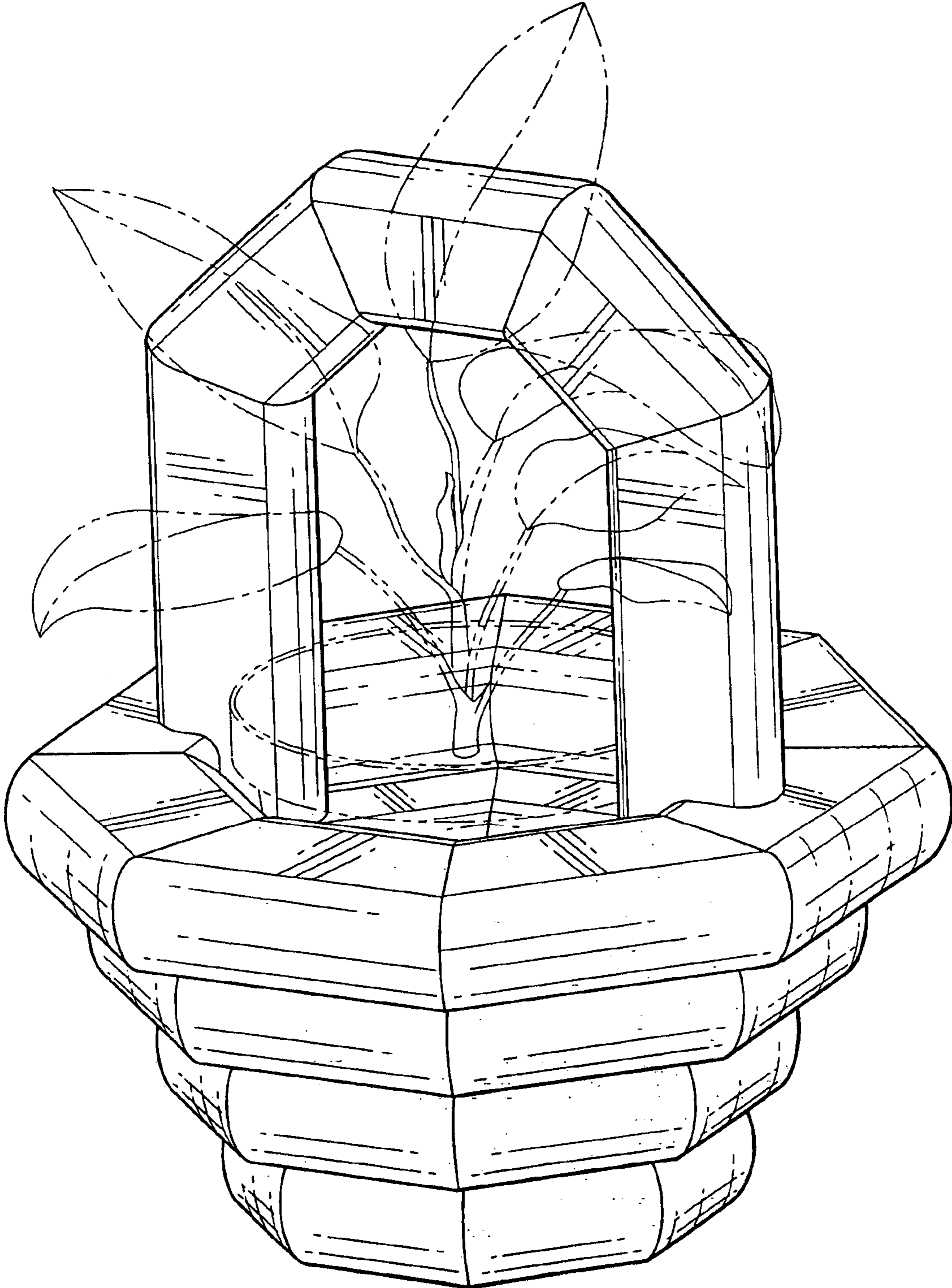
**FIG. 3**



**FIG. 4**



**FIG. 5**



**FIG. 6**