

US00D500647S

(12) **United States Design Patent**
So

(10) **Patent No.:** **US D500,647 S**

(45) **Date of Patent:** **** Jan. 11, 2005**

(54) **FOUR-IN-ONE OPENER**

(76) **Inventor:** **Shun So**, 2nd Floor, Chuan Yuan
Factory Building, 342-344 Kwun Tong
Road, Kwun Tong, Kowloon (HK)

(**) **Term:** **14 Years**

(21) **Appl. No.:** **29/192,918**

(22) **Filed:** **Nov. 3, 2003**

(30) **Foreign Application Priority Data**

Feb. 5, 2003 (EP) 000018155

(51) **LOC (7) Cl.** **07-99**

(52) **U.S. Cl.** **D8/34; D8/40**

(58) **Field of Search** D8/16-20, 33-35,
D8/38-43, 88, 89, 105; 7/138, 151-166;
30/1.5, 169, 400-450; 81/3.05-3.49; 294/15

(56) **References Cited**

U.S. PATENT DOCUMENTS

D47,263 S * 4/1915 Ladd D8/89

OTHER PUBLICATIONS

Bull's Pocket Guide to Corkscrews by Donald A. Bull;
©1999, Schiffer Publishing; ISBN:0-7643-0793-2; p. 79
opener bottom of page second from the right.*

Just For Openers A Guide to Beer, Soda, & Other Openers
by Donald A. Bull & John R. Stanley; ©1999; Schiffer
Publishing; ISBN:0-7643-0846-7; p. 127 top left, Q-40
twist off cap remover.*

Soda Advertising Openers by Donald A. Bull & John R.
Stanley; ©2000, Schiffer Publishing; □□ISBN:
0-7643-1056-9; p. 116, middle of page, Vess tab-popper.*

* cited by examiner

Primary Examiner—Caron D. Veynar

(74) *Attorney, Agent, or Firm*—Leydig, Voit & Mayer, Ltd.

(57) **CLAIM**

The ornamental design for a four-in-one opener, as shown.

DESCRIPTION

FIG. 1 is a top perspective view of a four-in-one opener
showing my new design;

FIG. 2 is a bottom perspective view thereof;

FIG. 3 is a top plan view thereof;

FIG. 4 is a bottom plan view thereof;

FIG. 5 is a left side elevational view thereof;

FIG. 6 is a right side elevational view thereof;

FIG. 7 is a rear elevational view thereof; and,

FIG. 8 is a front elevational view thereof.

1 Claim, 5 Drawing Sheets

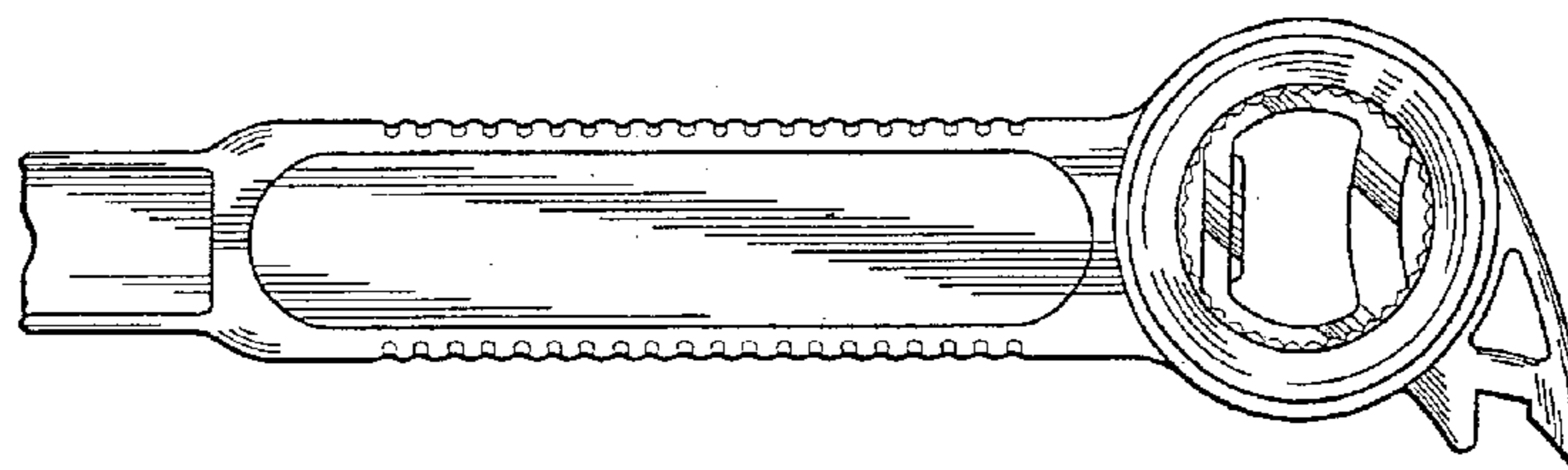
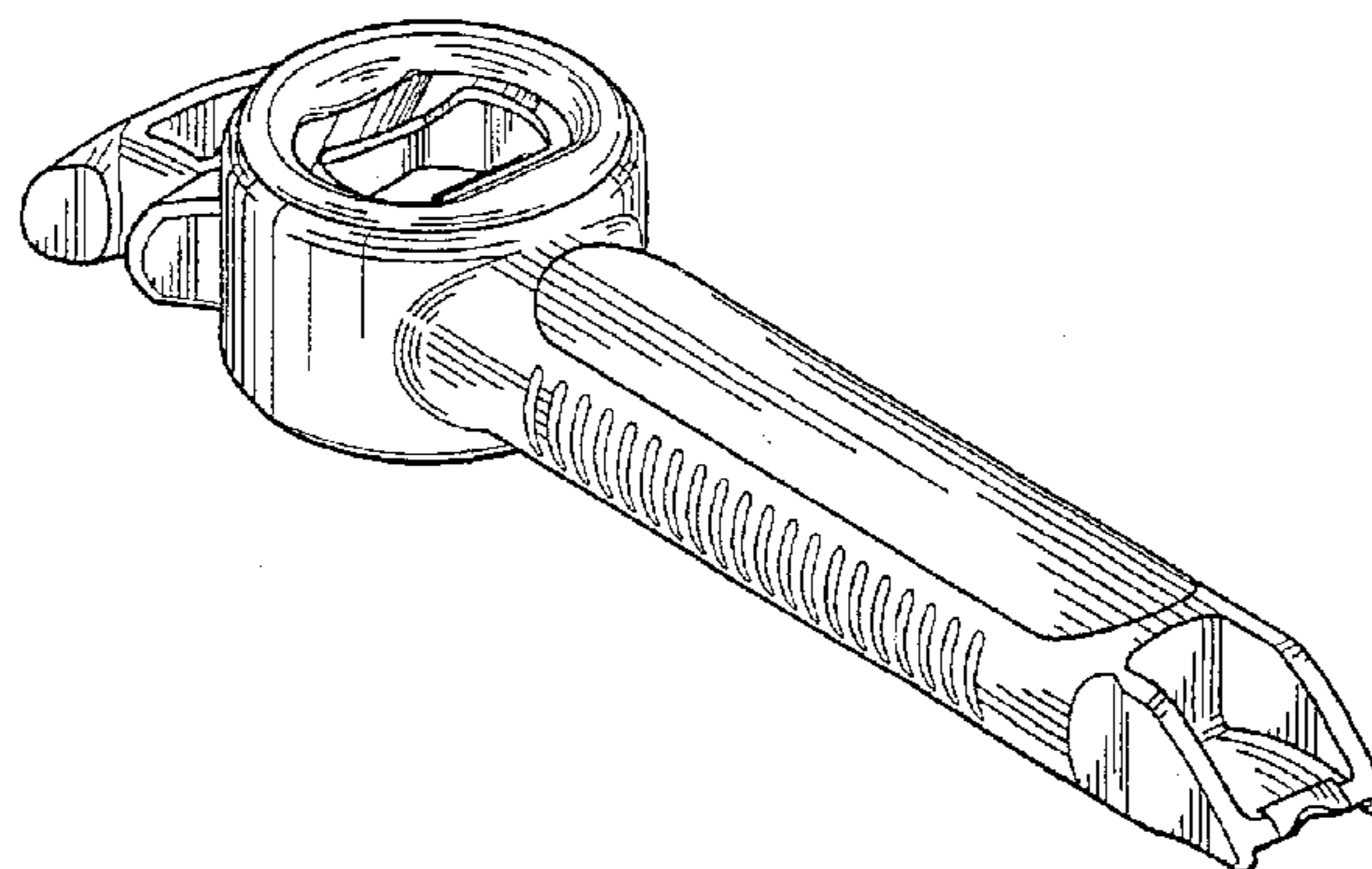

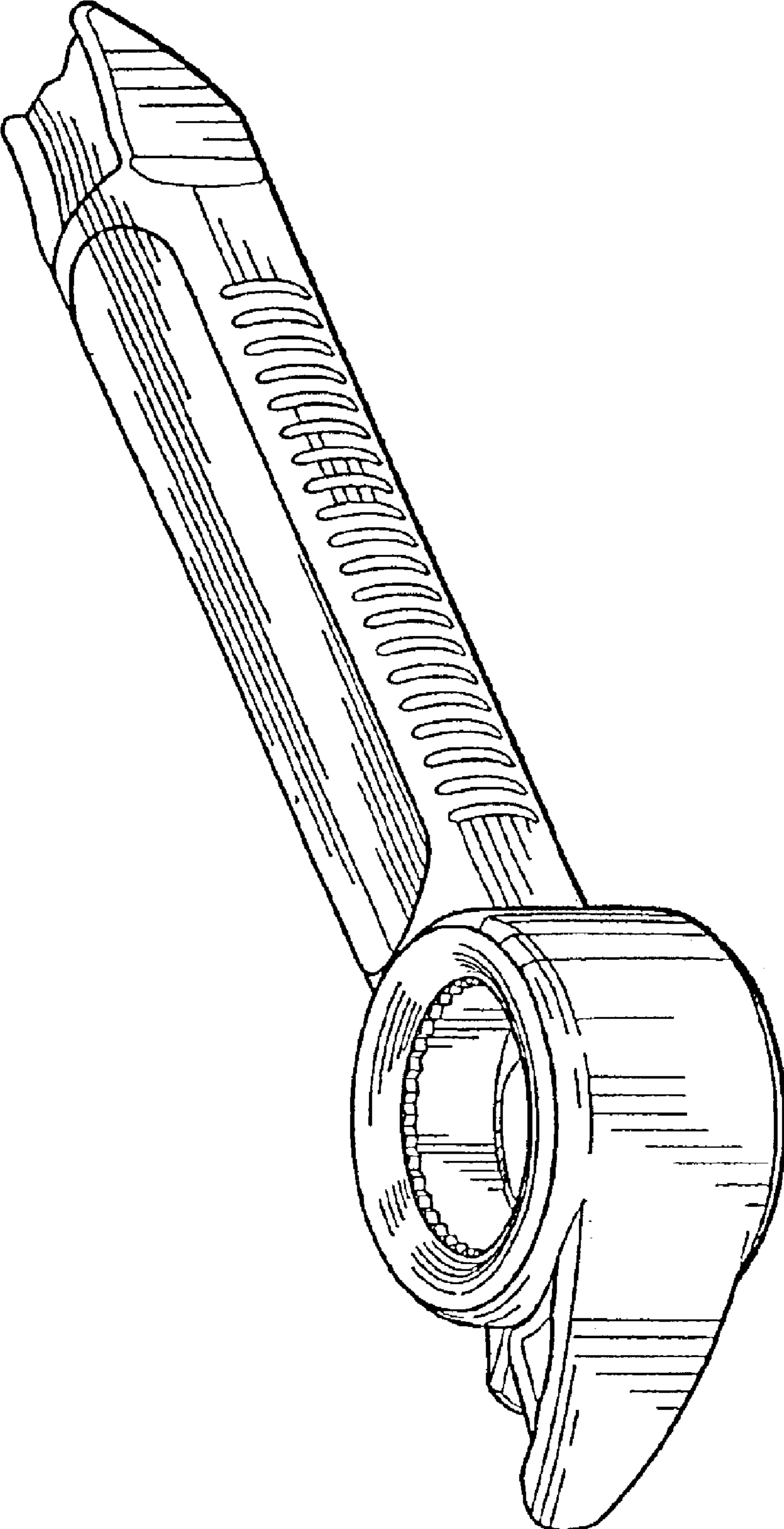

FIG. 1

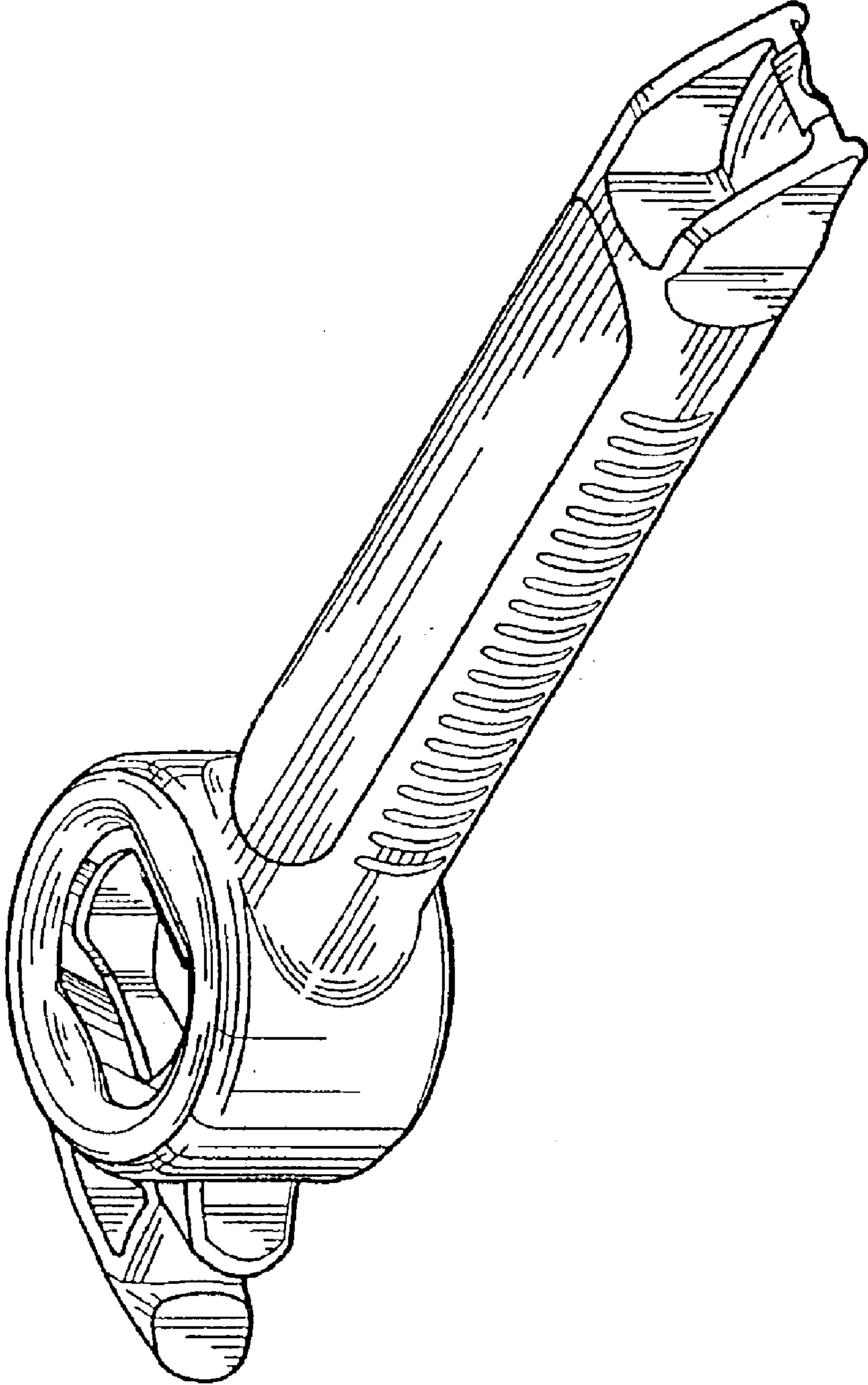

FIG. 2

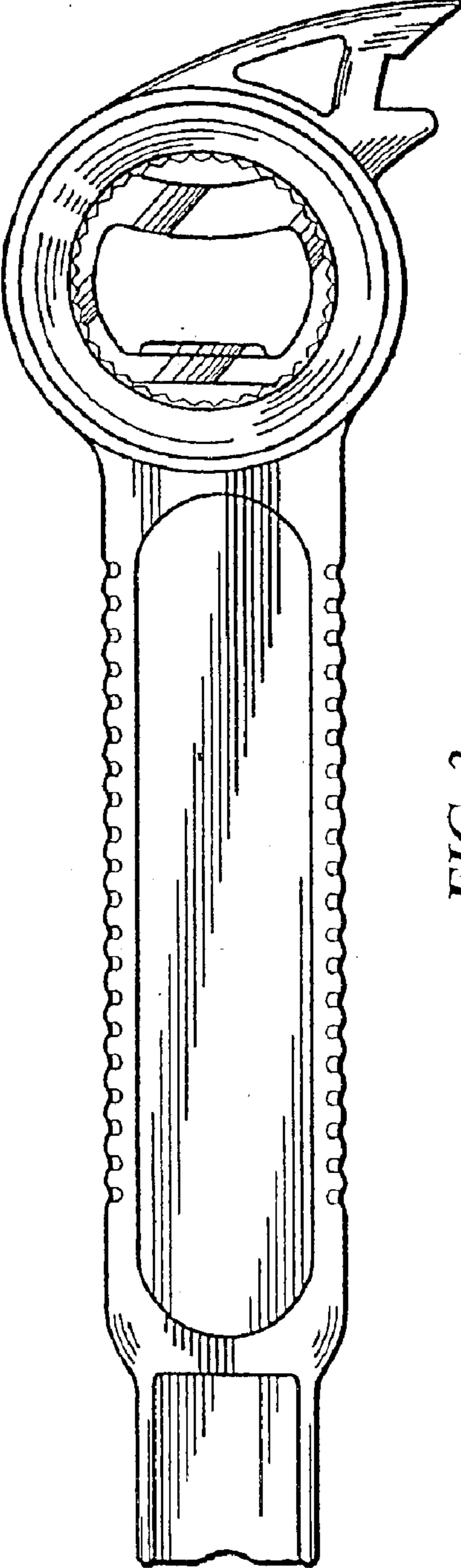

FIG. 3

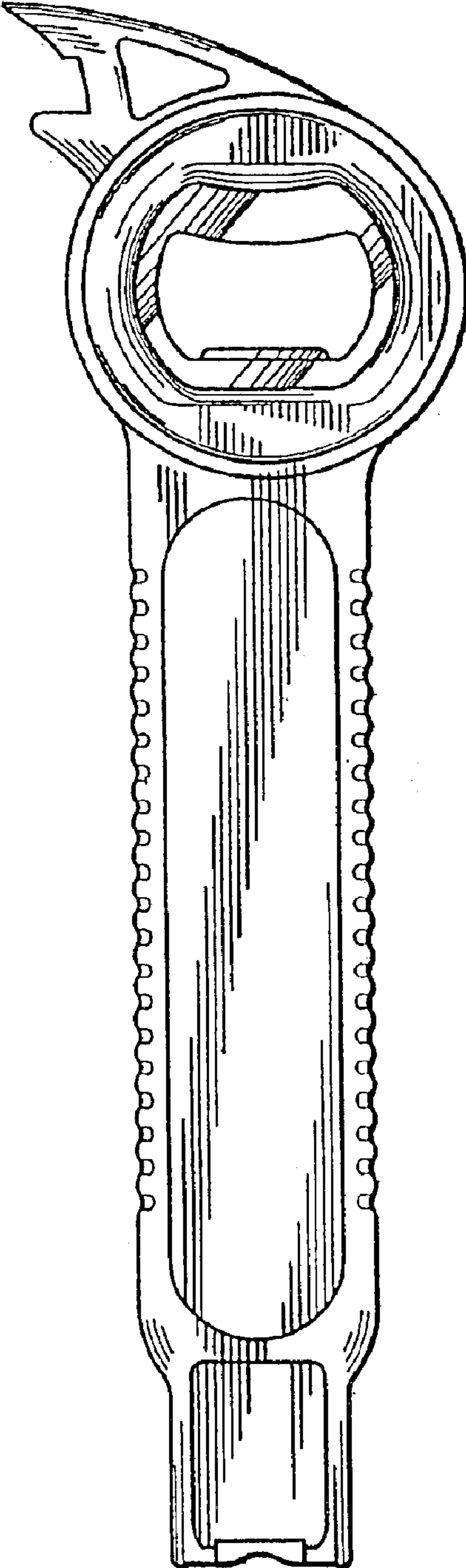

FIG. 4

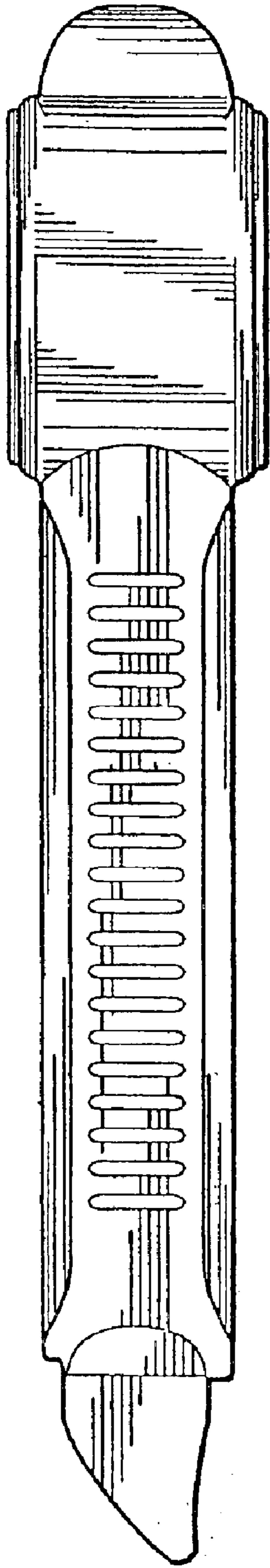

FIG. 5

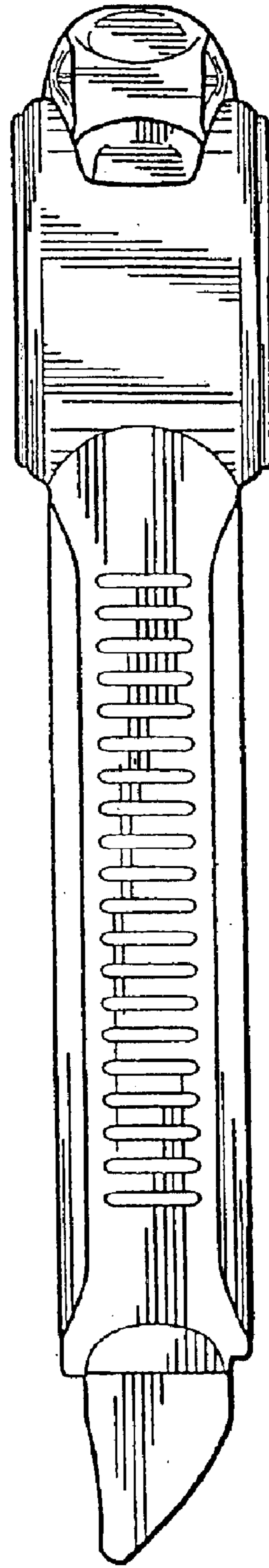

FIG. 6

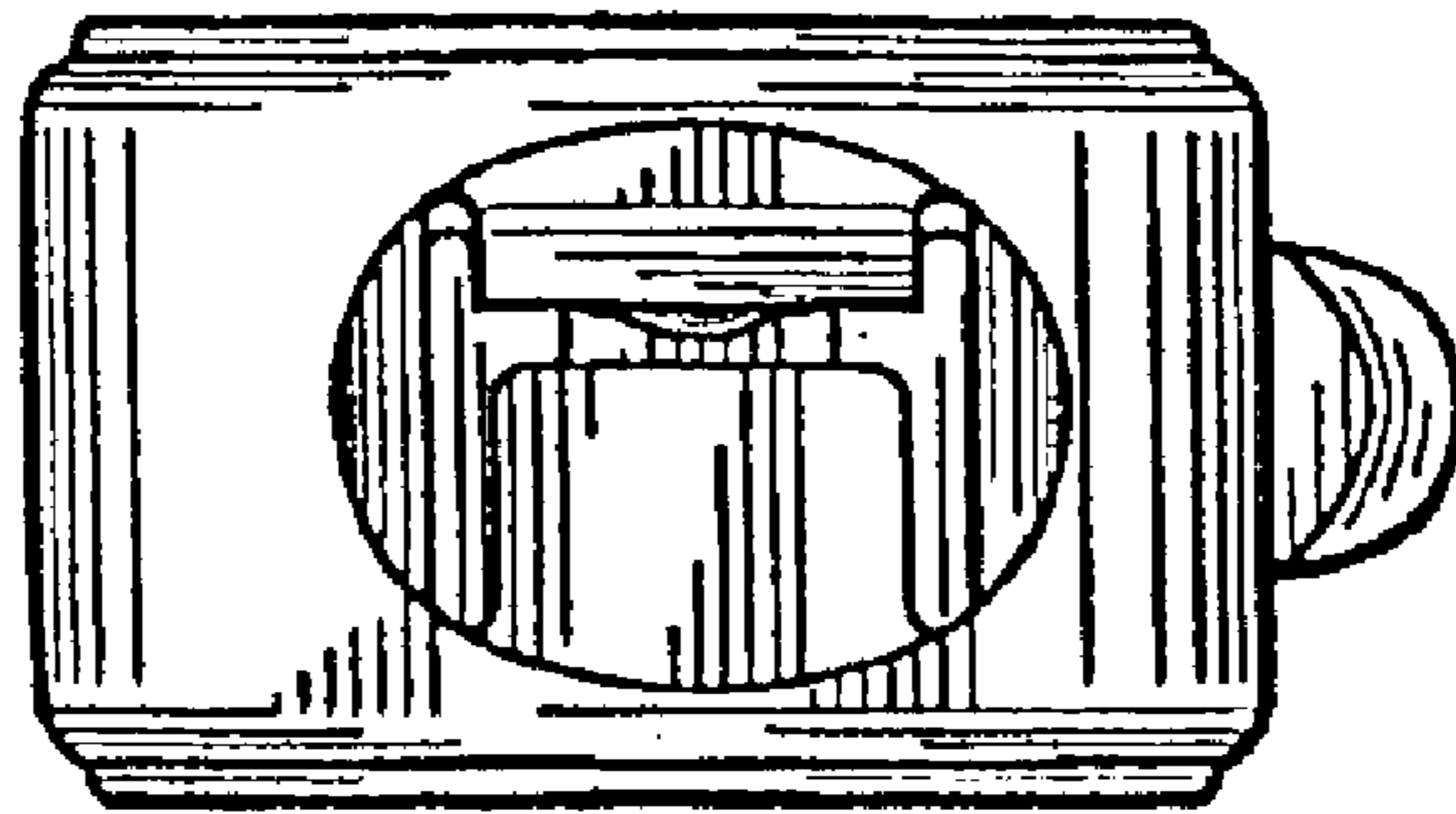

FIG. 7

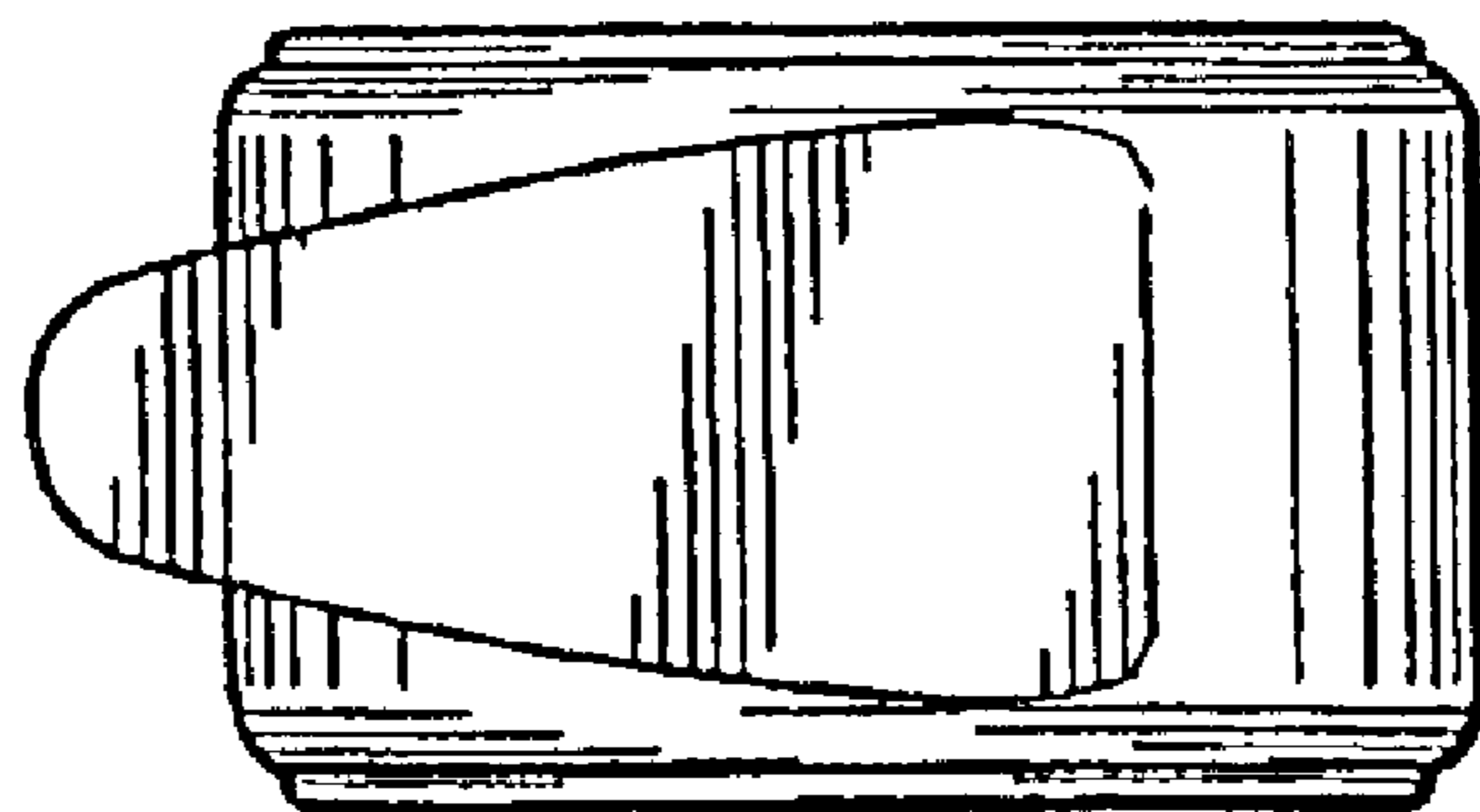

FIG. 8

UNITED STATES PATENT AND TRADEMARK OFFICE
CERTIFICATE OF CORRECTION

PATENT NO. : Des. 500,647 S
APPLICATION NO. : 29/192918
DATED : January 11, 2005
INVENTOR(S) : Shun So

Page 1 of 1

It is certified that error appears in the above-identified patent and that said Letters Patent is hereby corrected as shown below:

On the title page: item

(30) Foreign Application Priority Data should read

--May 2, 2003-- (EP).....000018155--

Signed and Sealed this

Twenty-fourth Day of April, 2007

A handwritten signature in black ink on a dotted background. The signature reads "Jon W. Dudas" in a cursive style.

JON W. DUDAS

Director of the United States Patent and Trademark Office