



US00D500550S

(12) **United States Design Patent** (10) **Patent No.:** **US D500,550 S**  
**Bariou et al.** (45) **Date of Patent:** **\*\* Jan. 4, 2005**

(54) **LAVATORY CLEANING DEVICE**

(75) Inventors: **Mathieu Bariou**, Wayne, NJ (US); **Ann Bongiorno**, Wayne, NJ (US); **Robert Clauson**, Edgewater, NJ (US); **Leonard Spitzer**, Montvale, NJ (US)

(73) Assignee: **Reckitt Benckiser Inc.**, Wayne, NJ (US)

(\*\*) Term: **14 Years**

(21) Appl. No.: **29/176,096**

(22) Filed: **Feb. 18, 2003**

(30) **Foreign Application Priority Data**

Aug. 24, 2002 (GB) ..... 3006476

(51) **LOC (7) Cl.** ..... **23-04**

(52) **U.S. Cl.** ..... **D23/368**

(58) **Field of Search** ..... D23/366-369;  
239/34, 57-59, 60

(56) **References Cited**

**U.S. PATENT DOCUMENTS**

D393,901 S \* 4/1998 Kuhn ..... D23/368

\* cited by examiner

*Primary Examiner*—Lisa Lichtenstein

(74) *Attorney, Agent, or Firm*—Norris McLaughlin & Marcus PA

(57) **CLAIM**

The ornamental design for a lavatory cleaning device, as shown and described.

**DESCRIPTION**

FIG. 1 is a perspective view of the lavatory cleaning device. FIG. 2 is a plan view from one side of the lavatory cleaning device.

FIG. 3 is plan view of another side of the lavatory cleaning device.

FIG. 4 is a plan view from one side of the lavatory cleaning device.

FIG. 5 is a plan view from one side of the lavatory cleaning device.

FIG. 6 is a plan view from the top of the lavatory cleaning device; and,

FIG. 7 is a plan view from the bottom of the lavatory cleaning device.

Portions of the lavatory cleaning device depicted by dotted lines form no part of the design of the lavatory cleaning device.

**1 Claim, 2 Drawing Sheets**

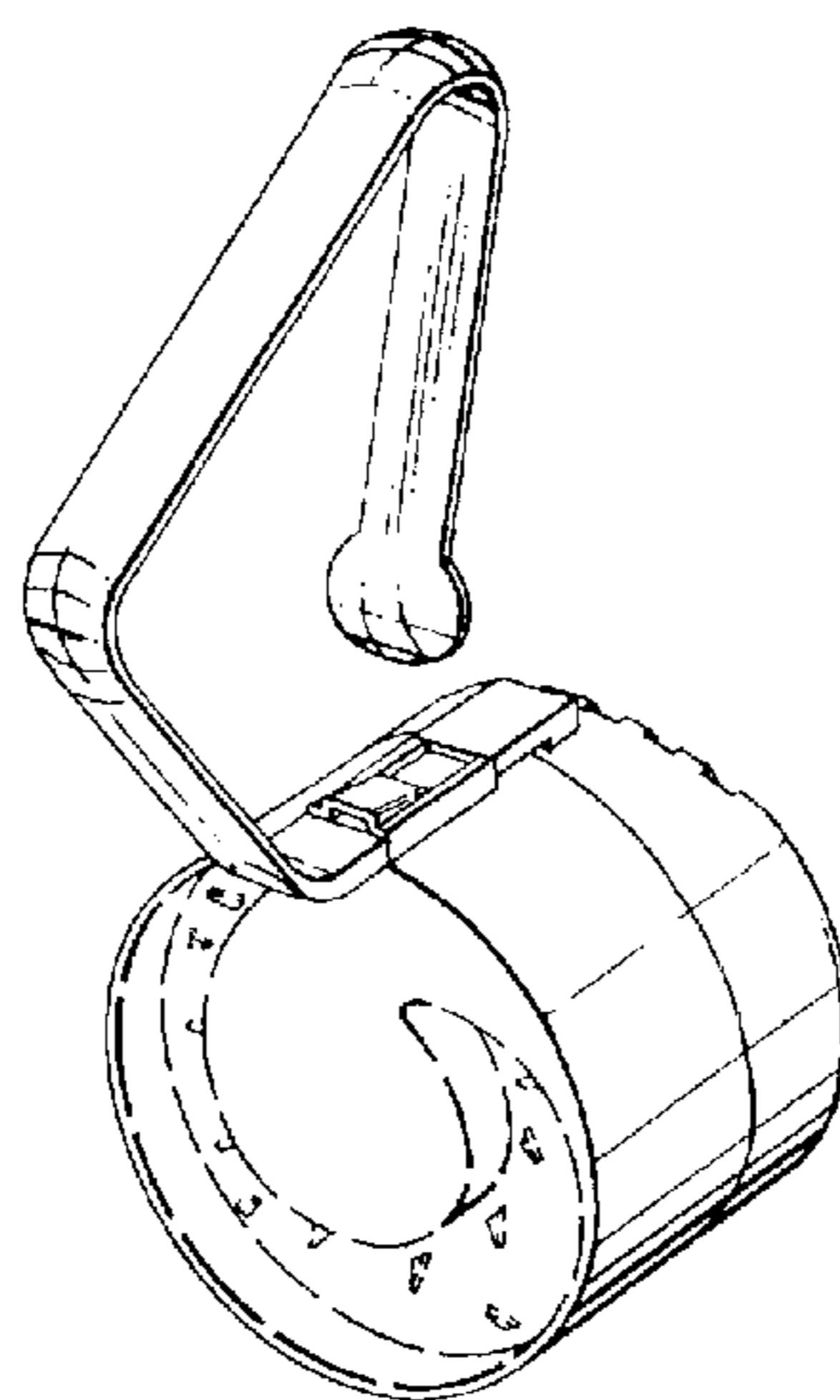

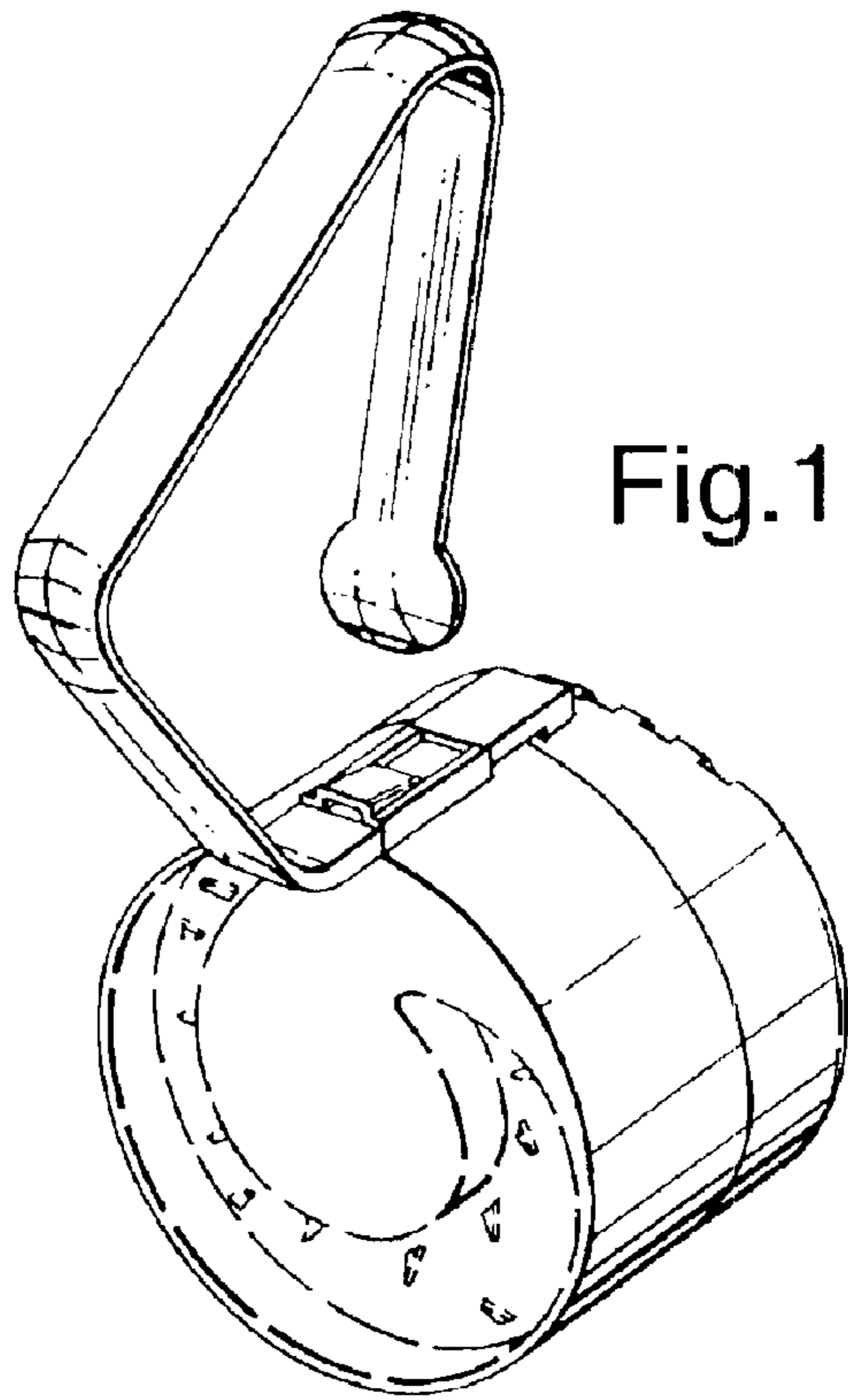

Fig.1.

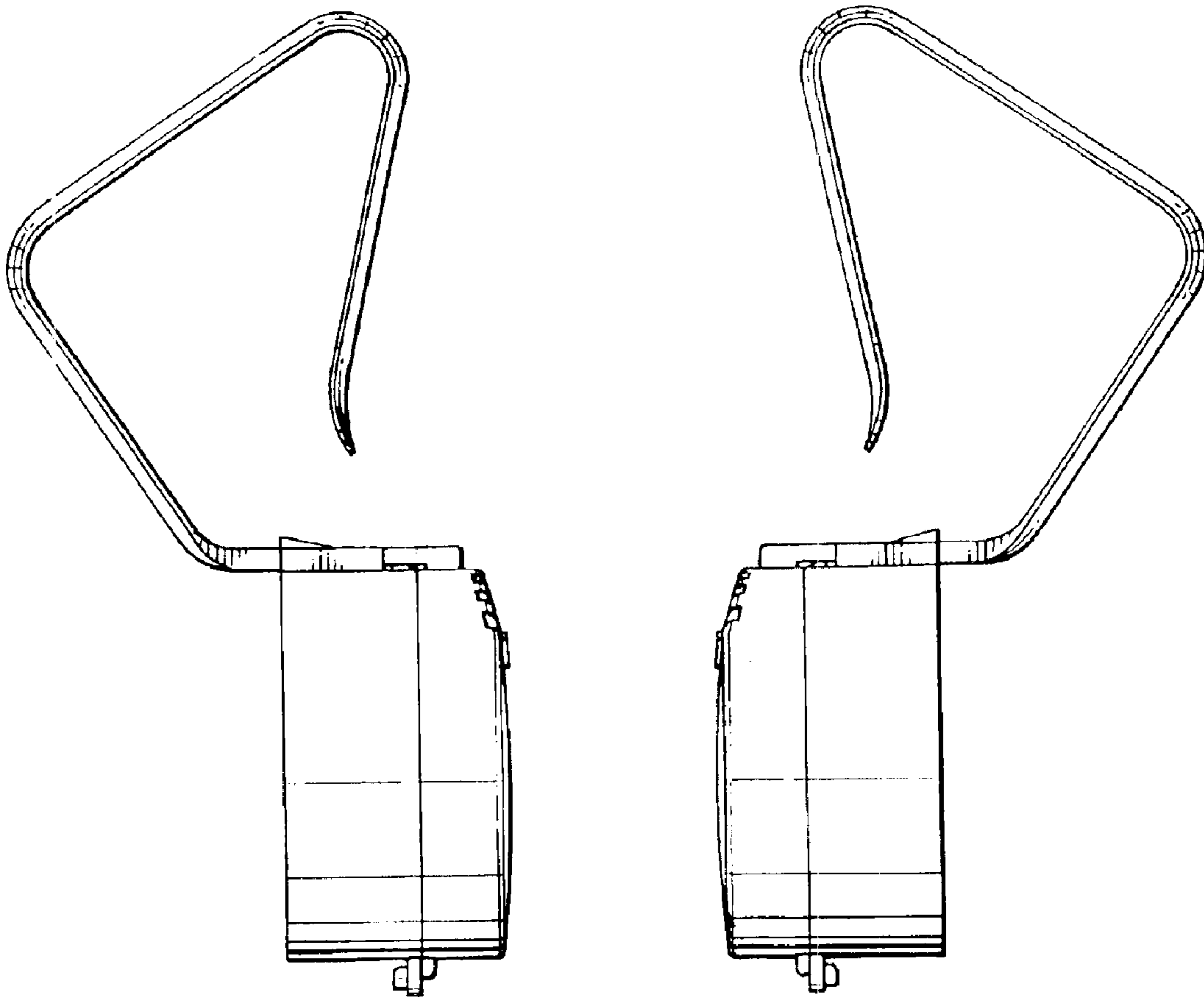

Fig.2.

Fig.3.

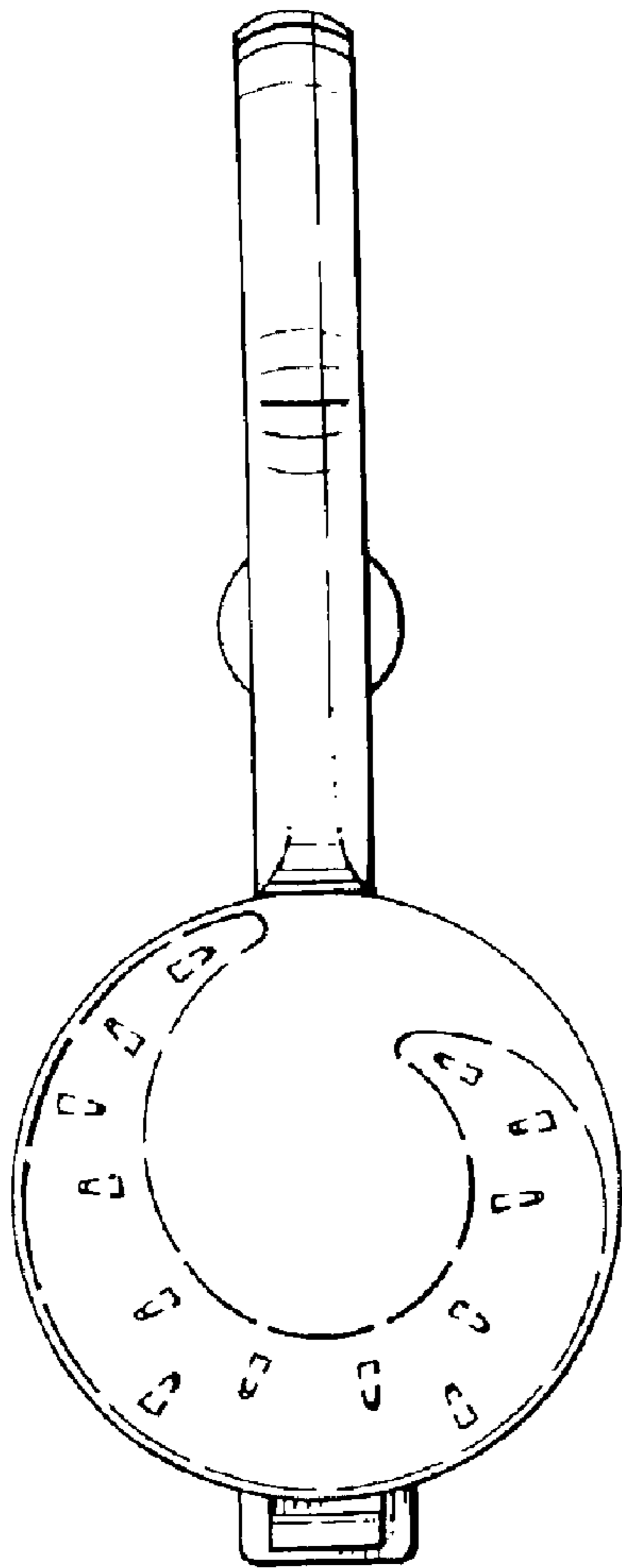

Fig.4.

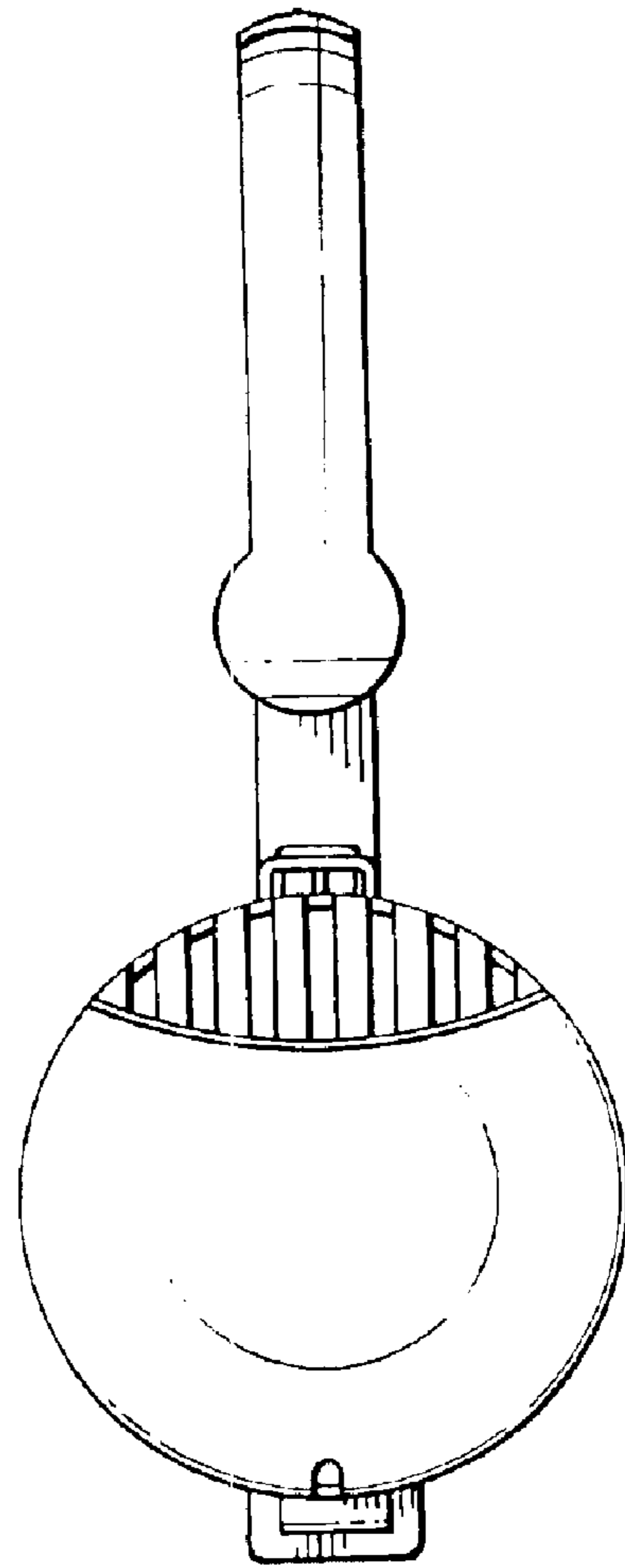

Fig.5.

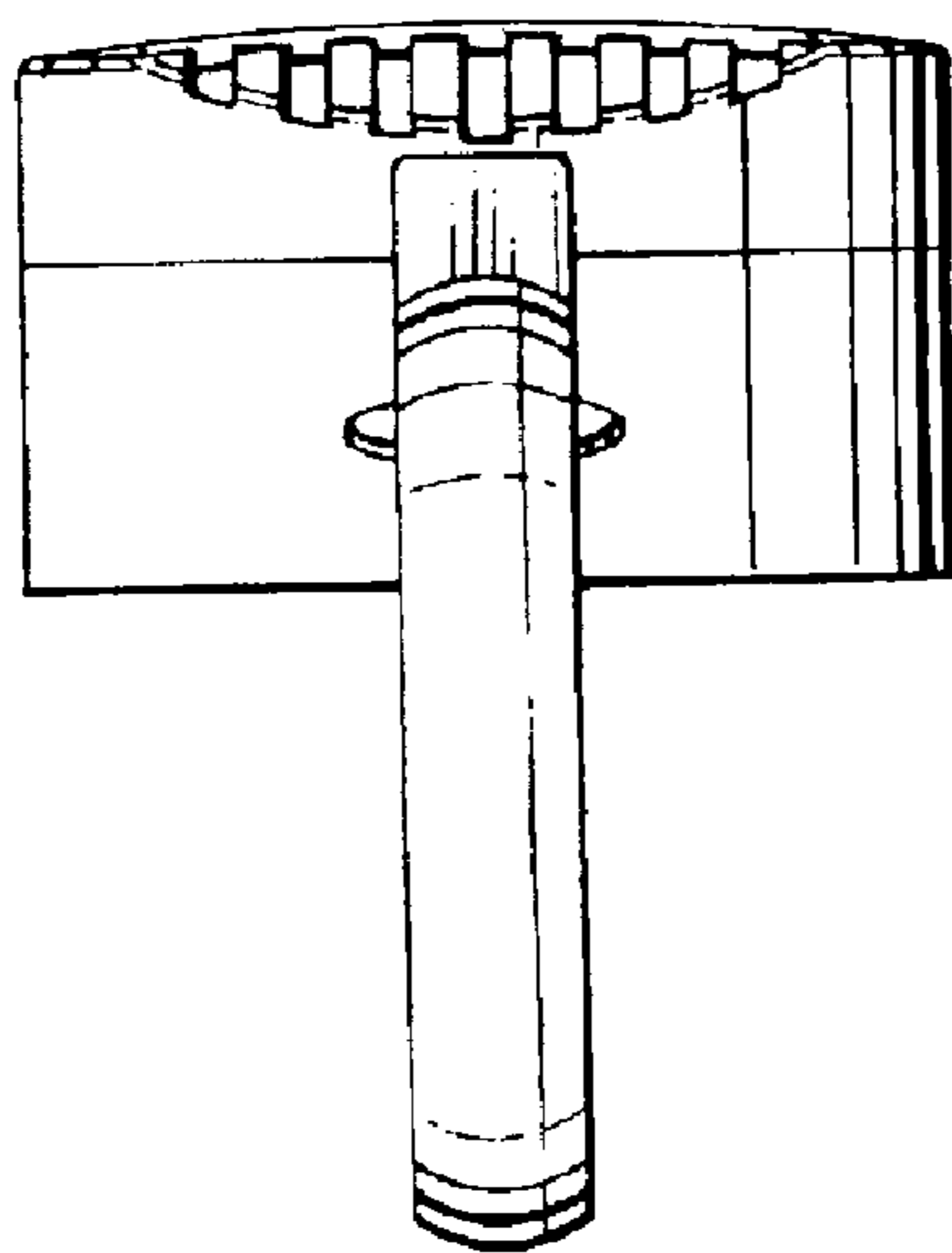

Fig.6.

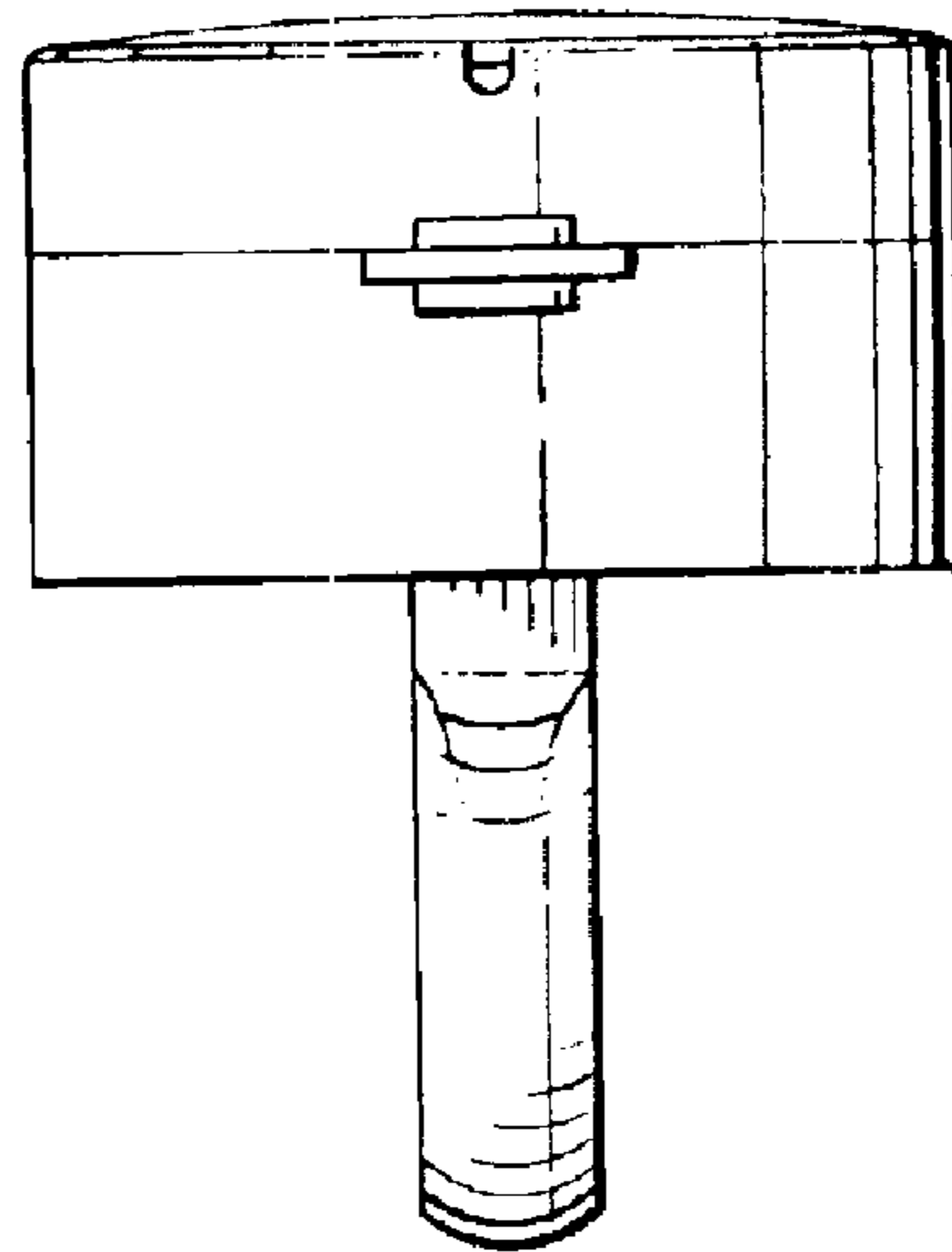

Fig.7.