



US00D500533S

(12) **United States Design Patent**
Thompson

(10) **Patent No.: US D500,533 S**
(45) **Date of Patent: ** Jan. 4, 2005**

(54) **COMBINED BASKETBALL STACKING
PUZZLE AND PIECES**

(76) Inventor: **Raymond B. Thompson, 2756
Marshall St., Falls Church, VA (US)
22042**

(**) Term: **14 Years**

(21) Appl. No.: **29/178,413**

(22) Filed: **Mar. 27, 2003**

Related U.S. Application Data

(63) Continuation-in-part of application No. 29/175,365, filed on
Feb. 5, 2003.

(51) **LOC (7) Cl. 21-01**

(52) **U.S. Cl. D21/478**

(58) **Field of Search** D21/300, 301,
D21/314-319, 471, 478, 479, 386, 707-714;
D9/337, 338, 341, 307, 418, 441, 451;
D11/131, 157; D19/42, 97; D7/651, 654;
D3/211; 273/153 R, 156, 157 R, 153 P,
146, 241, 258-260, 264, 271, 276, 288,
290; 206/579, 315.1, 315.9, 775, 776, 781,
557, 564

(56) **References Cited**

U.S. PATENT DOCUMENTS

- 2,151,030 A * 3/1939 Hinsen 273/146 X
- 3,624,939 A * 12/1971 Gossard D9/307 X
- 3,837,652 A 9/1974 Kuwagaki et al.
- 3,945,645 A 3/1976 Roberts
- 4,057,247 A 11/1977 Morrison
- 4,060,247 A 11/1977 Kobres, Jr.
- 4,325,552 A 4/1982 Glasheen
- 4,988,103 A 1/1991 Cheng
- 5,381,895 A * 1/1995 Thomsen 206/315.9

(List continued on next page.)

OTHER PUBLICATIONS

Tetra Toys Export Catalogue, 23: 20 Ball Adult Puzzle.*
Hong Kong Toys Feb. 1995, p. 318: balls inside basket and
golf type ball at top of page; smooth tennis type ball under
lower bat.*

(List continued on next page.)

Primary Examiner—Stella Reid

Assistant Examiner—C. Tuttle

(74) *Attorney, Agent, or Firm*—Cahn & Samuels, LLP

(57) **CLAIM**

The ornamental design for a combined basketball stacking
puzzle and pieces, as shown and described.

DESCRIPTION

FIG. 1 is a perspective view of my new design for a
combined basketball stacking puzzle and pieces in its
assembled state;

FIG. 2 is a perspective view shown without the cover for a
clear disclosure of the stacked puzzle pieces;

FIG. 3 is a top view of FIG. 1.

FIG. 4 is a bottom view with the base removed to show the
undersides of the assembled puzzle pieces;

FIG. 5 is a perspective view showing the base and piece
elements of the design in a partially assembled state;

FIG. 6 is a top perspective view of the base portion of the
design;

FIG. 7 is a bottom view of cover portion of the design;

FIG. 8 is a bottom and side perspective view of the cover
portion of the design;

FIG. 9 is a perspective view showing the puzzle piece
elements of the design in an unassembled state;

FIG. 10 is a top view showing of one of the puzzle piece
elements separately for clarity of disclosure; and,

FIG. 11 is a top view showing a pair of the puzzle piece
elements in a stacked relationship.

1 Claim, 5 Drawing Sheets

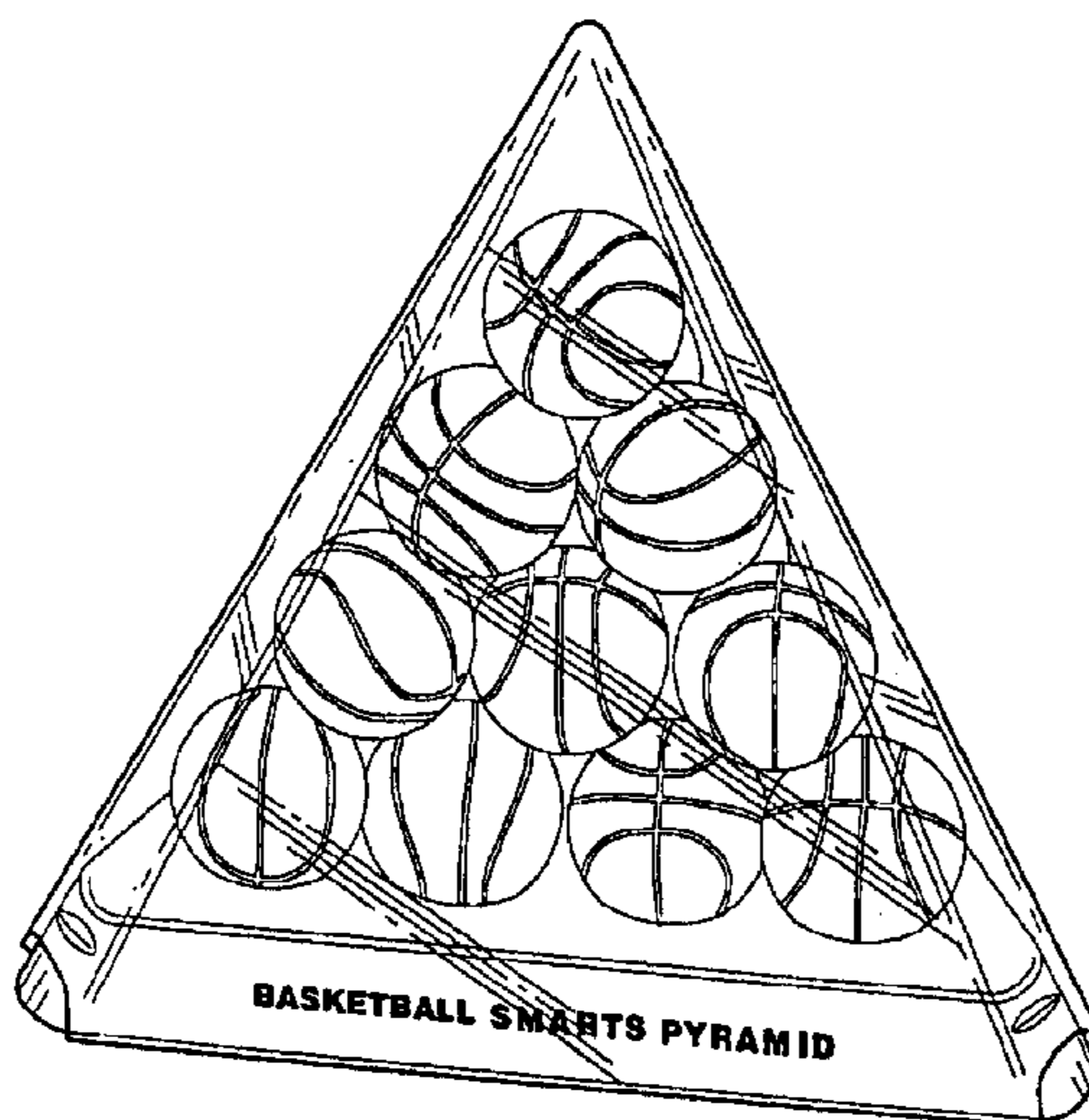

U.S. PATENT DOCUMENTS

D357,500 S * 4/1995 Mutterperl D21/713 X
D357,541 S * 4/1995 Neidell D24/197
D373,528 S * 9/1996 Ser Tuen Wei D9/418 X
5,558,331 A 9/1996 Zlotsky
5,695,312 A * 12/1997 Kelly 206/315.9 X
5,882,173 A * 3/1999 Ziegler 206/315.9
6,461,164 B1 * 10/2002 Ramelli 434/263

OTHER PUBLICATIONS

Hong Kong Toys Feb. 1996, p. 307: top row: items AT041, AT0448; third row: items AT468, fourth row: item AT469; fifth row: item AT043; sixth row: items AT0455; and bottom row: item AL0031.*

Hong Kong Toys, Jan. 1998: 1) p. 1005: top row center: football type balls; 2) p. 1649: baseball type balls at top and center of framed area, basketball type ball on upper right of framed area; and tennis type balls toward center of framed area; 3) pa.*

Austad's Golf Catalog, (undated): 1) logo balls inside cabinet shown in advertisement on back of order form; 2) p. 40: center golf ball with football motif at bottom of page.*

"Use Your Head Unlimited, Inc.: Games" web page printed from www.useyourheadunlimited.com/ssprmd.html circa 2001.

* cited by examiner

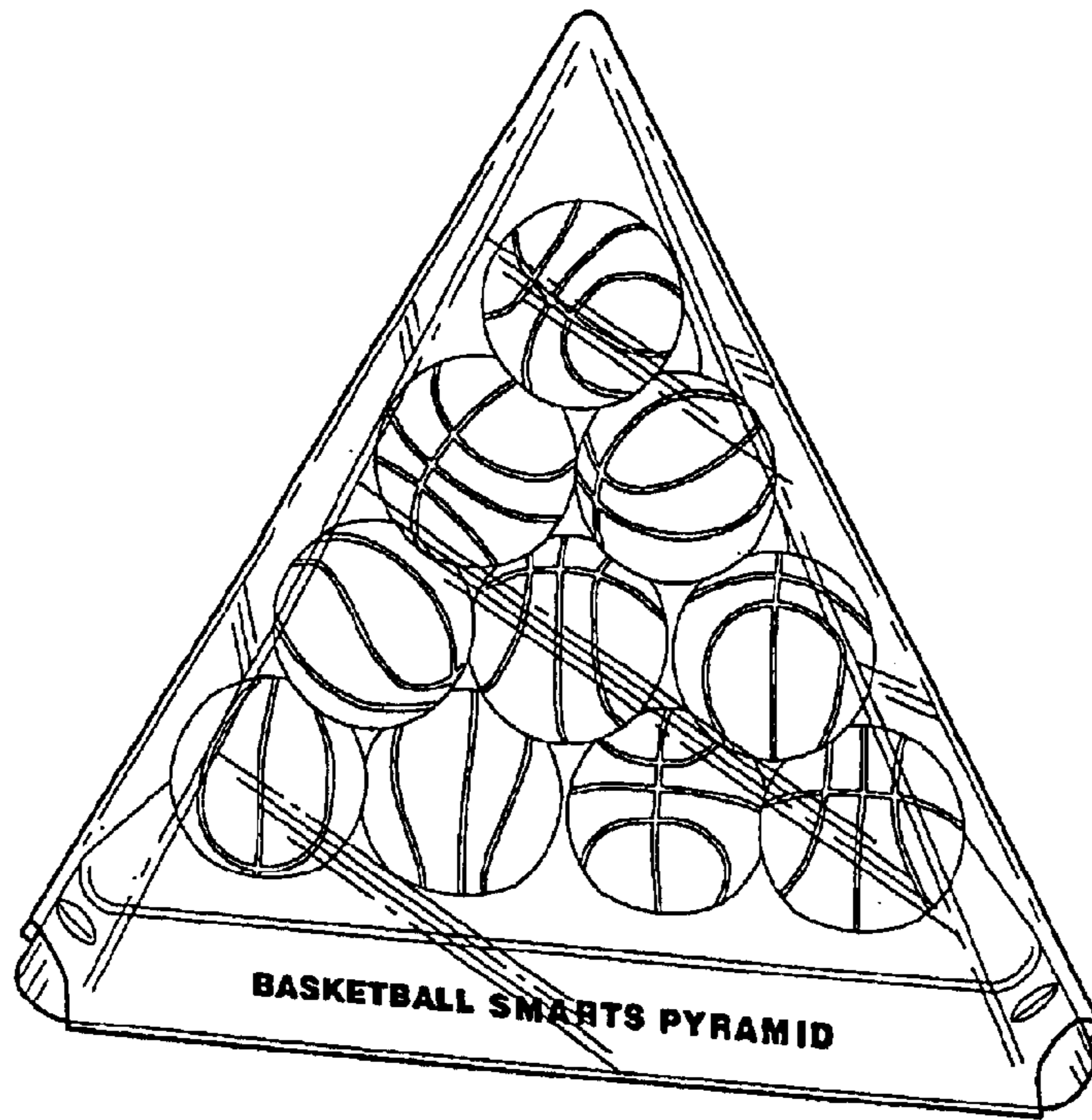

FIG. 1

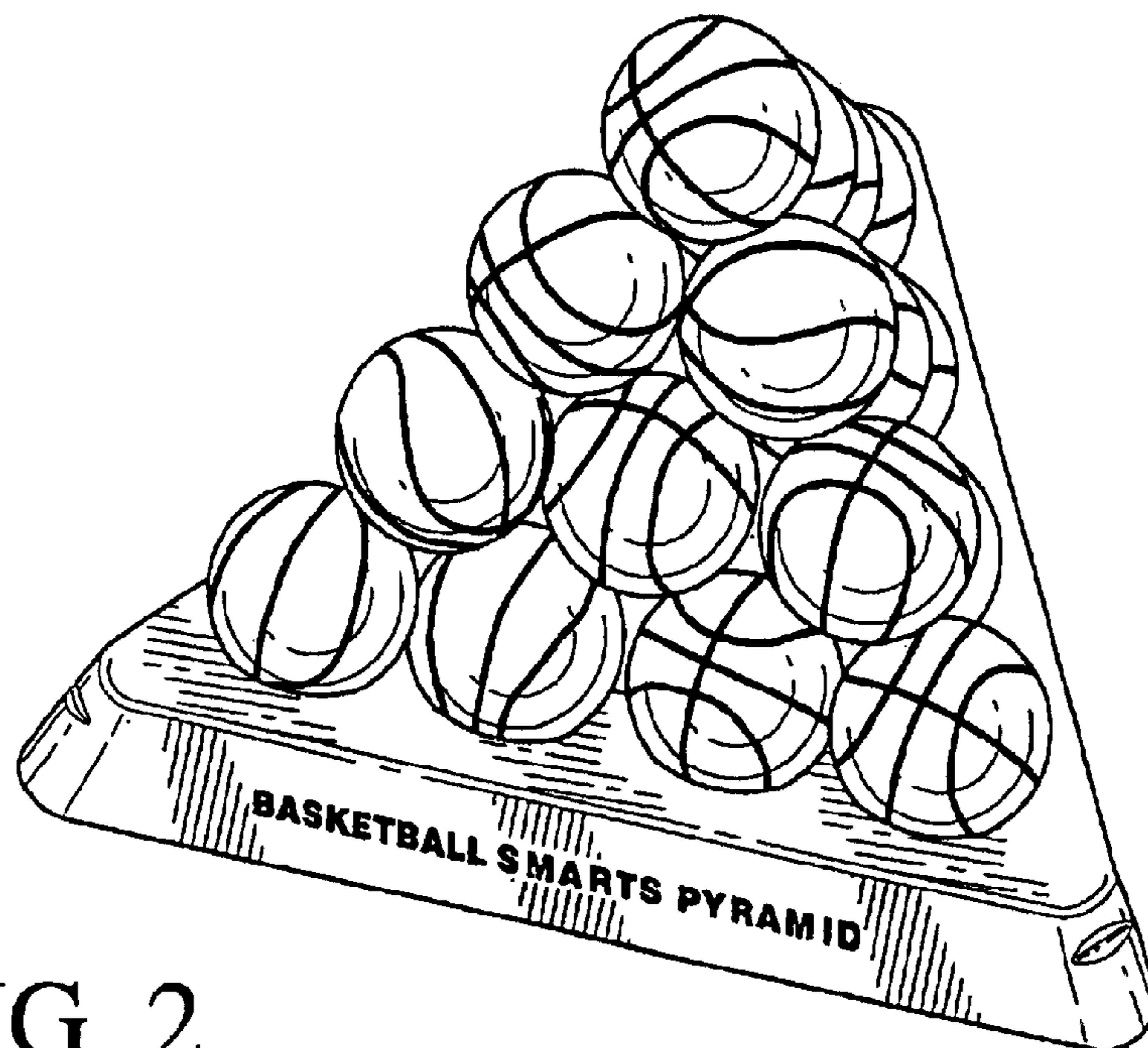

FIG. 2

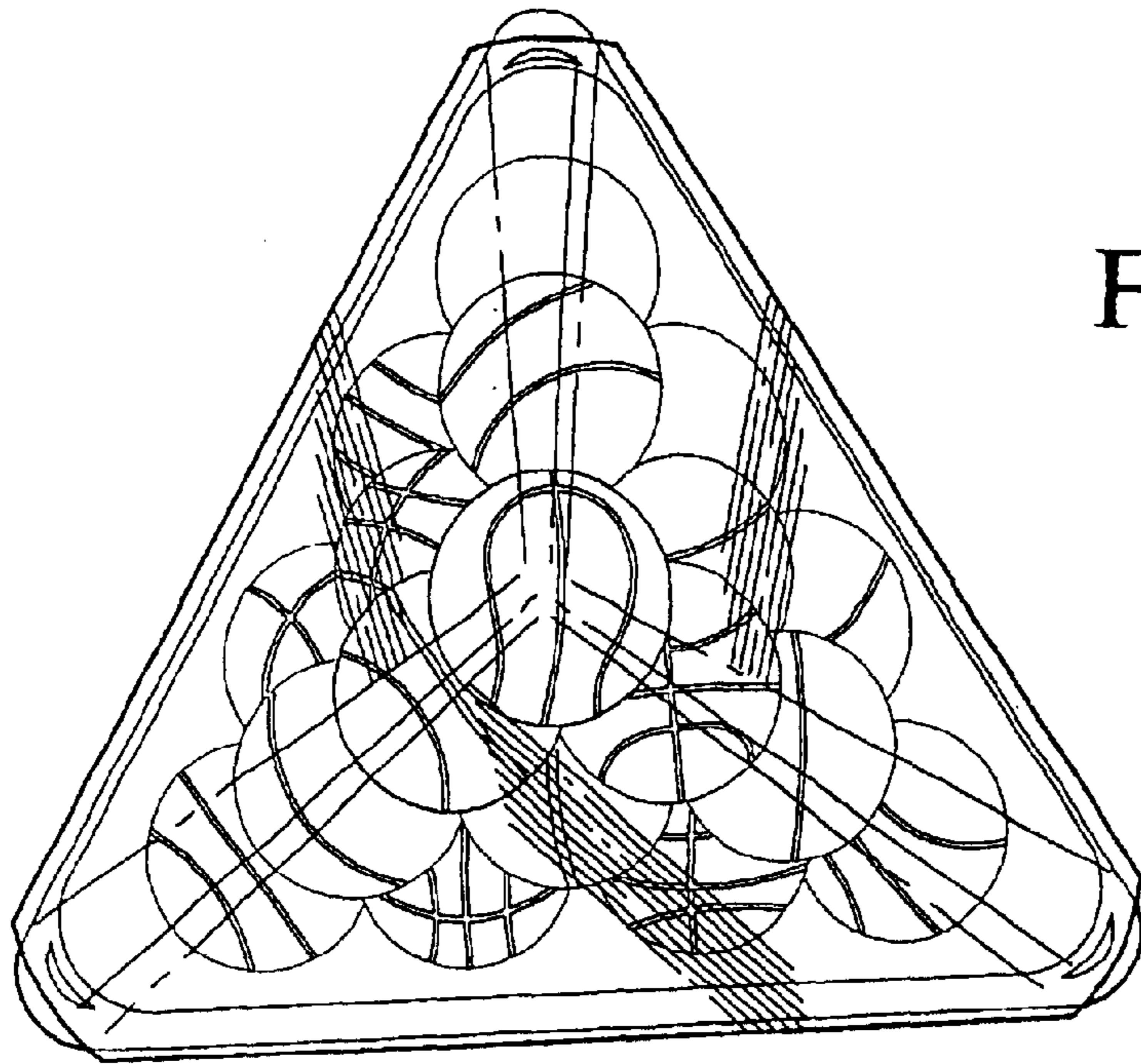
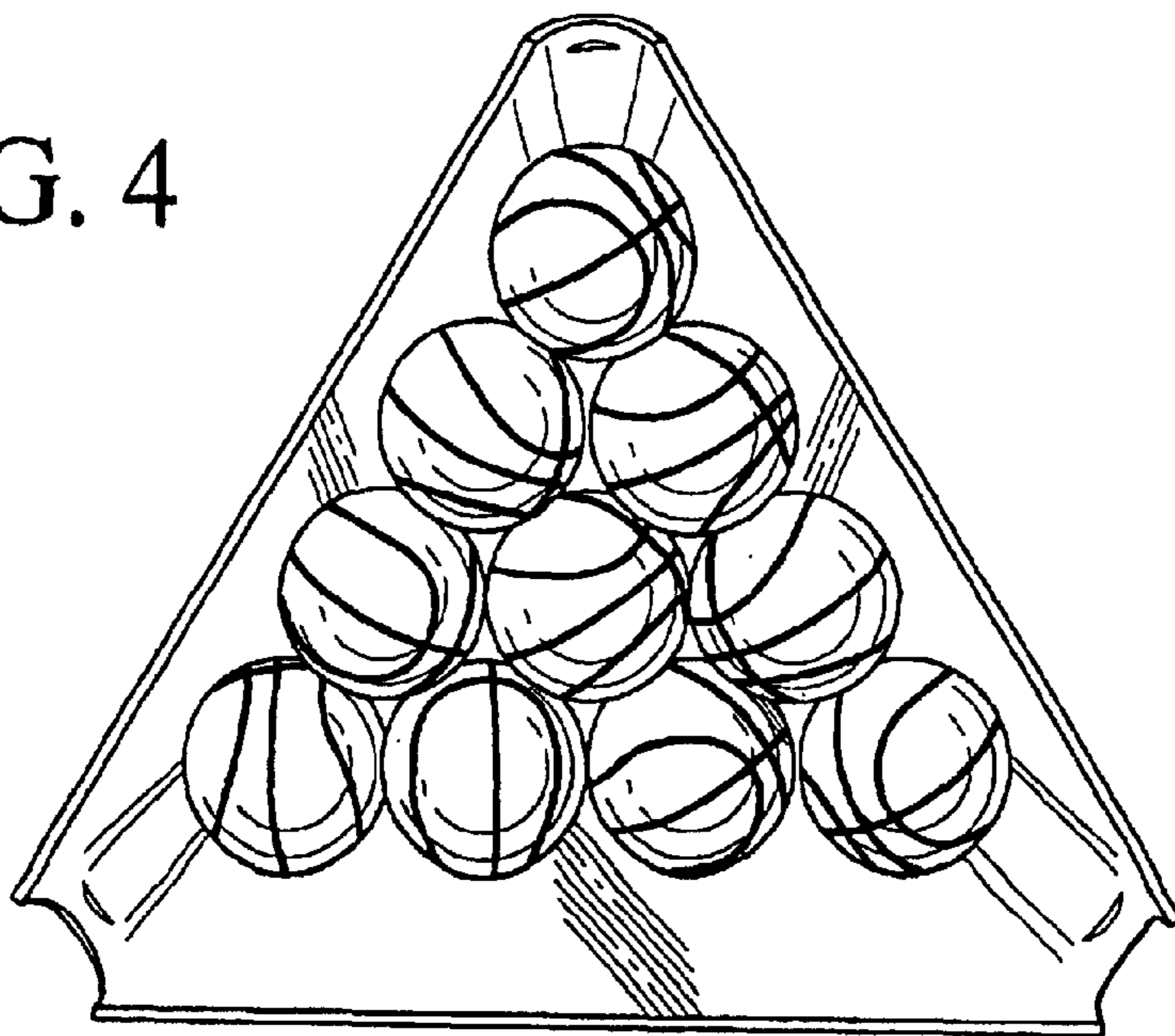

FIG. 3

FIG. 4



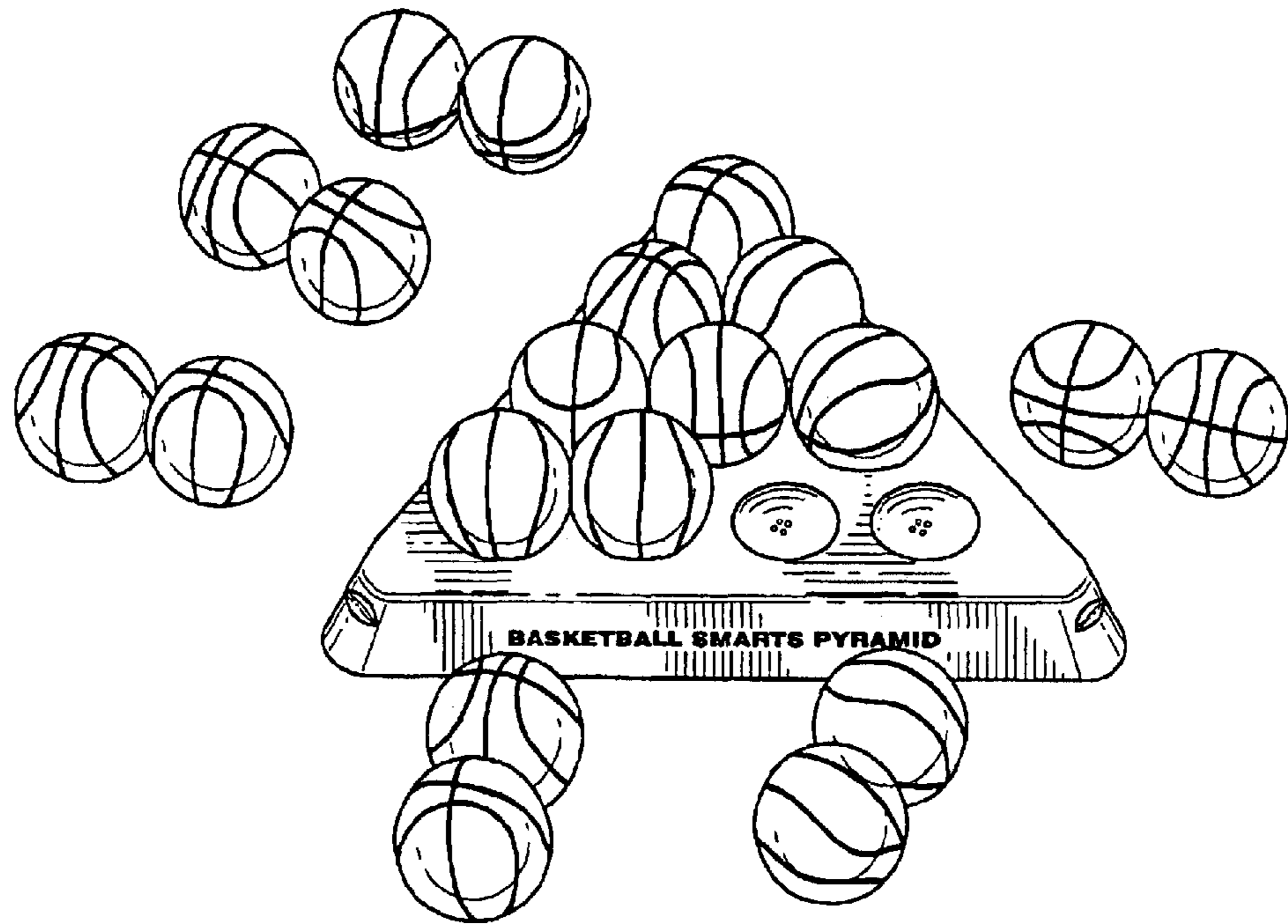

FIG. 5

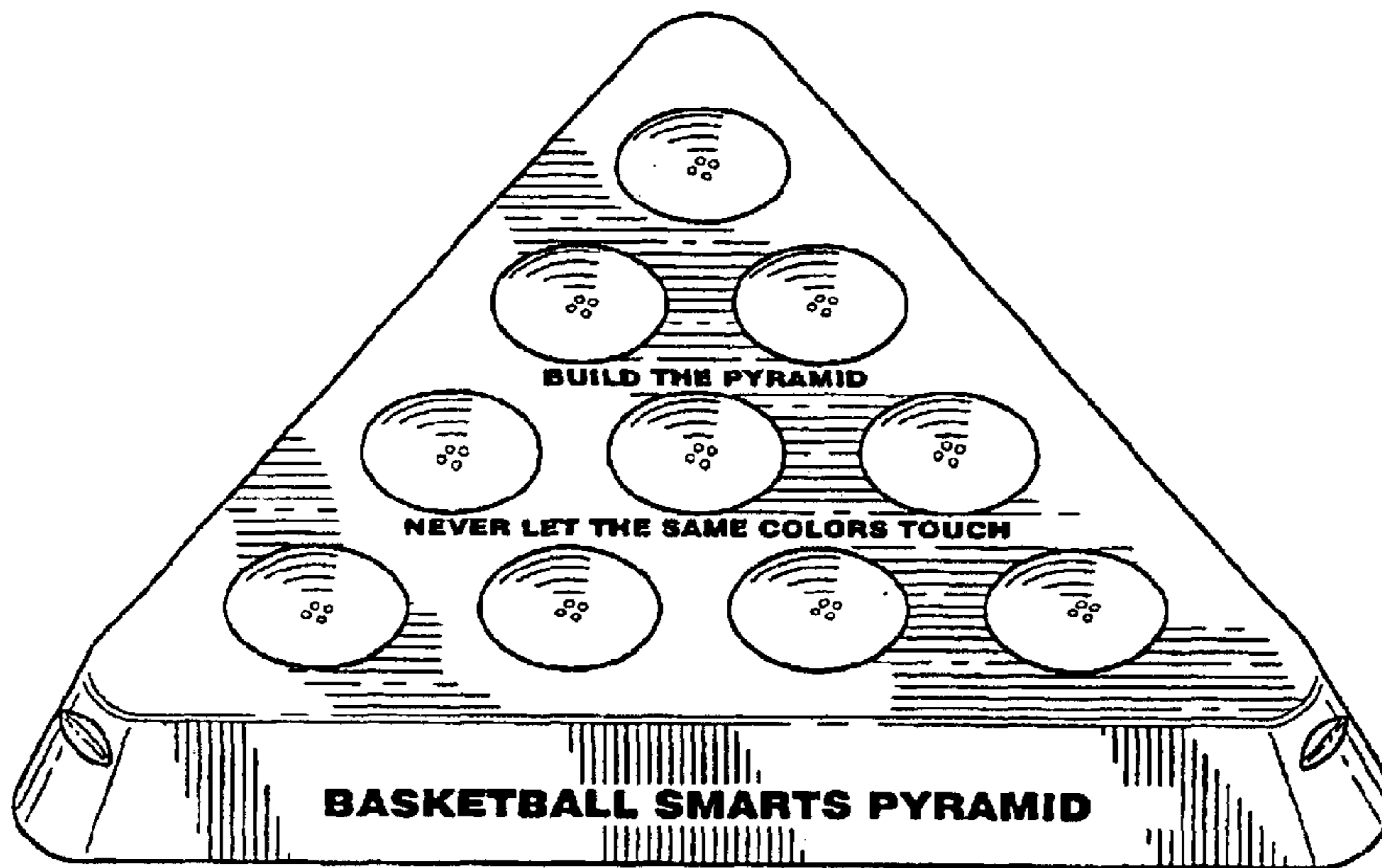

FIG. 6

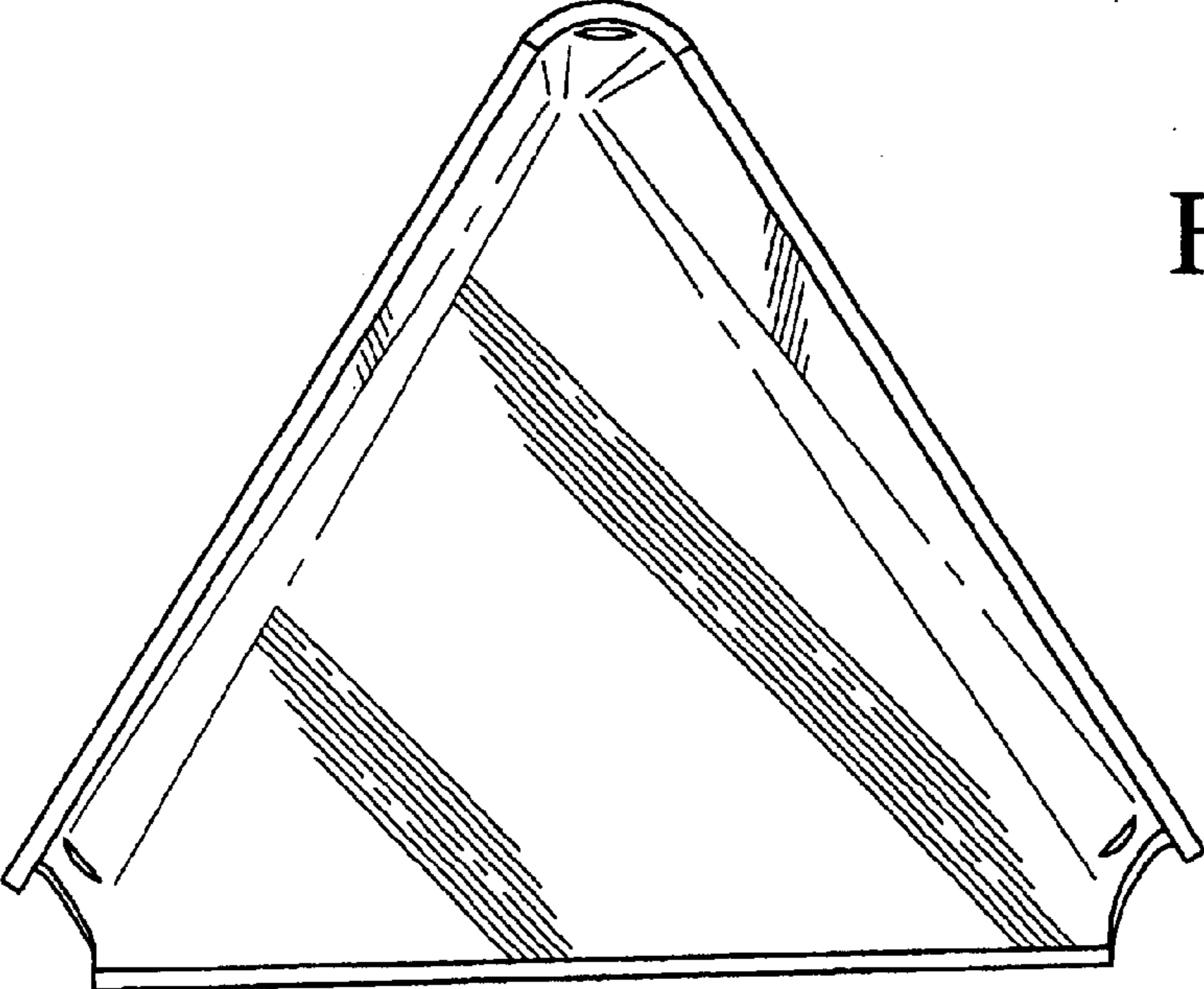

FIG. 7

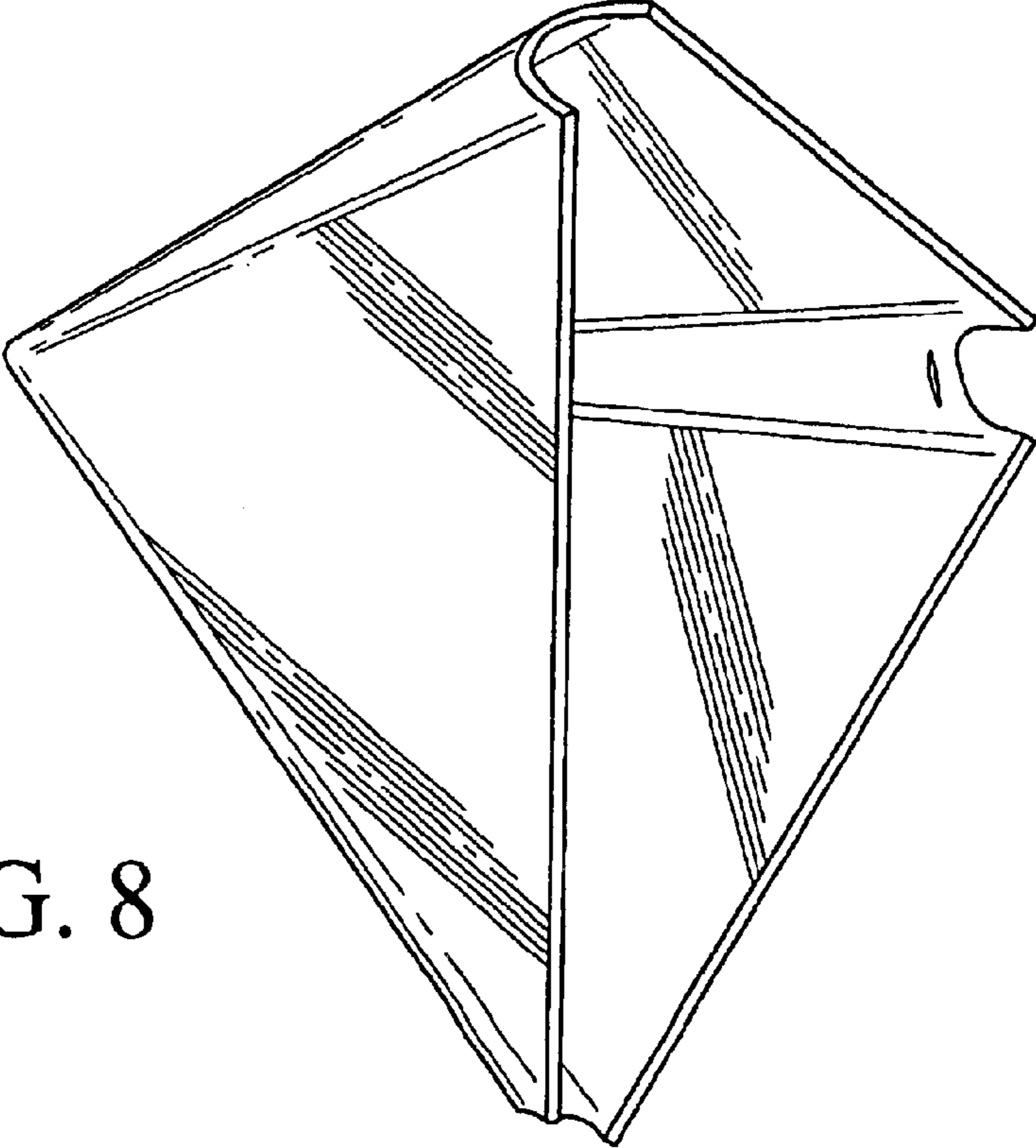

FIG. 8

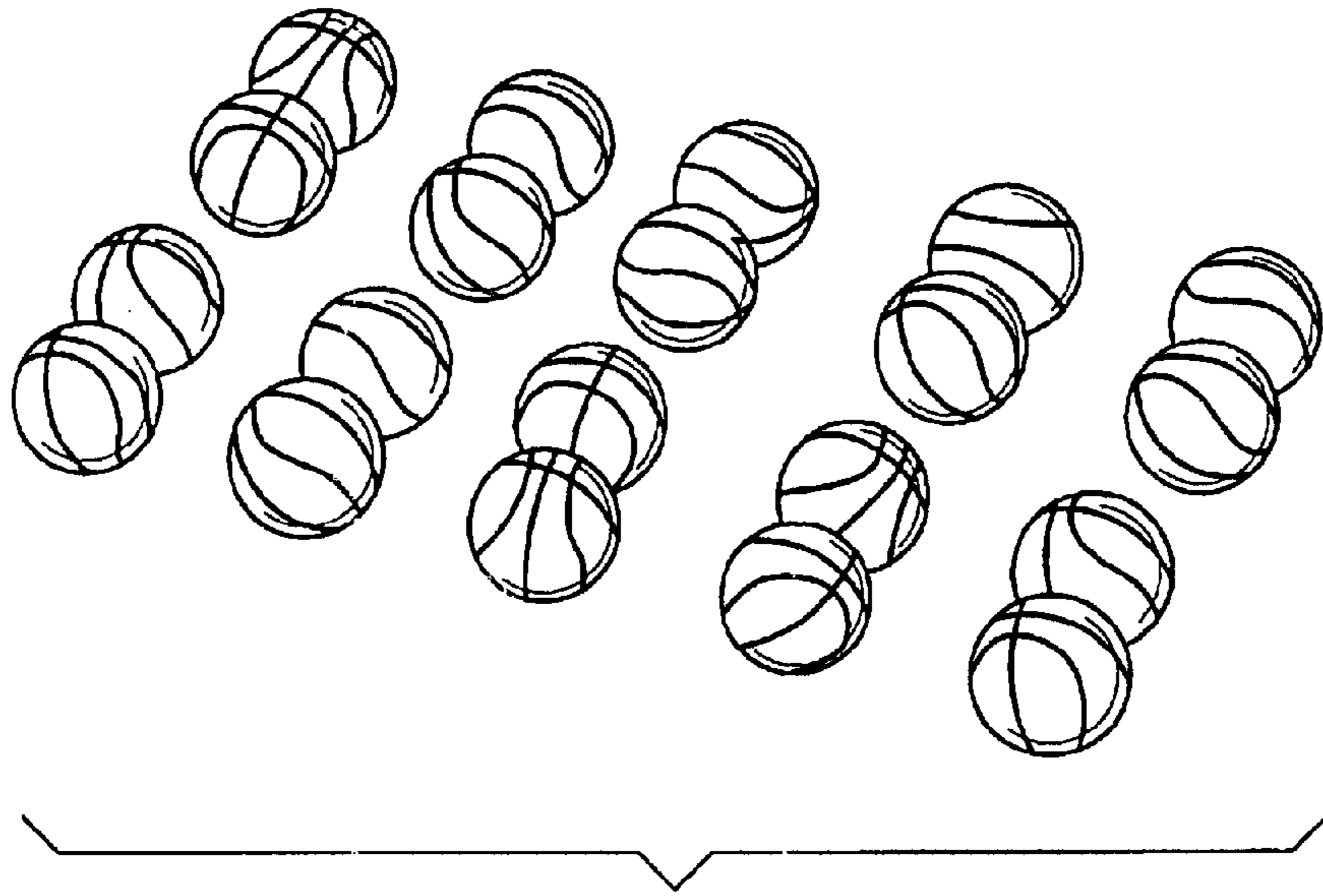

FIG. 9

FIG. 10

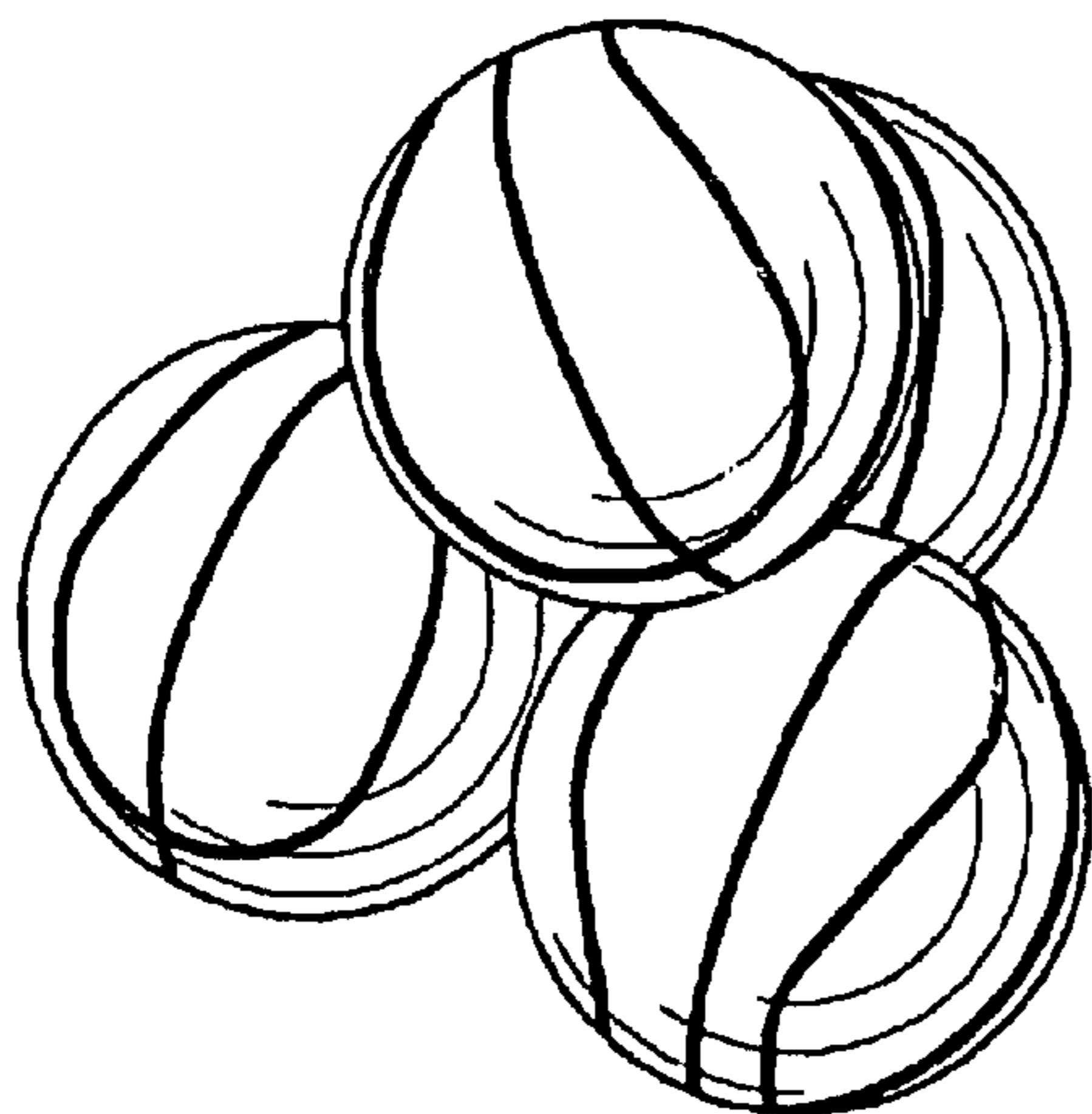
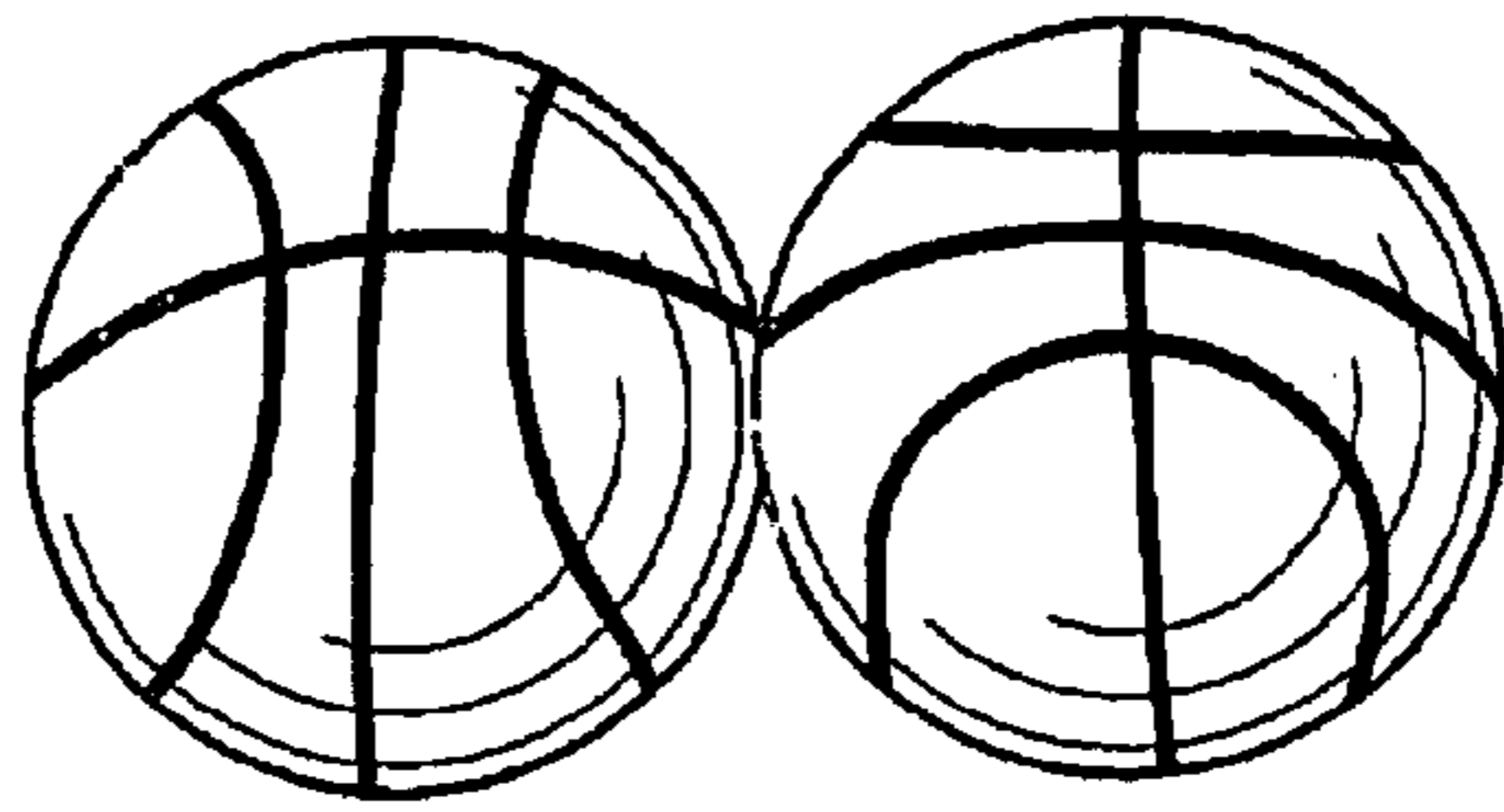

FIG. 11