

US00D500486S

(12) **United States Design Patent**
Zeitman

(10) **Patent No.:** **US D500,486 S**

(45) **Date of Patent:** **** Jan. 4, 2005**

(54) **PERSONAL RADIO**

(75) **Inventor:** **Josh Zeitman**, Brooklyn, NY (US)

(73) **Assignee:** **Lenoxx Electronics Corp.**, Brooklyn, NY (US)

(**) **Term:** **14 Years**

(21) **Appl. No.:** **29/197,458**

(22) **Filed:** **Jan. 16, 2004**

(51) **LOC (7) Cl.** **14-03**

(52) **U.S. Cl.** **D14/188**

(58) **Field of Search** D14/188, 137,
D14/155, 138, 193-198, 189; 455/73, 550.1,
344-351, 90.1-90.3, 573.1, 556, 1

(56) **References Cited**

U.S. PATENT DOCUMENTS

- 4,225,970 A * 9/1980 Jaramillo et al. 455/90.3
- D351,169 S * 10/1994 Leung D14/188
- D426,226 S * 6/2000 Ridinger D14/188
- 6,256,481 B1 * 7/2001 Jeong et al. 455/575.3

- D453,924 S * 2/2002 Chen D14/188
- 6,374,091 B1 * 4/2002 Richards et al. 455/90.1
- D473,537 S * 4/2003 Lammers-Meis D14/188
- D479,833 S * 9/2003 Chen D14/188
- 6,718,182 B1 * 4/2004 Kung 455/556.1

* cited by examiner

Primary Examiner—Prabhakar Deshmukh

(74) *Attorney, Agent, or Firm*—Burns, Doane, Swecker & Mathis, L.L.P.

(57) **CLAIM**

The ornamental design for a “personal radio”, as shown and described.

DESCRIPTION

FIG. 1 is a front view of a “personal radio” showing my design;

FIG. 2 is a rear view thereof;

FIG. 3 is a right side view thereof;

FIG. 4 is a left side view thereof;

FIG. 5 is a top plan view thereof; and,

FIG. 6 is a bottom view thereof.

1 Claim, 2 Drawing Sheets

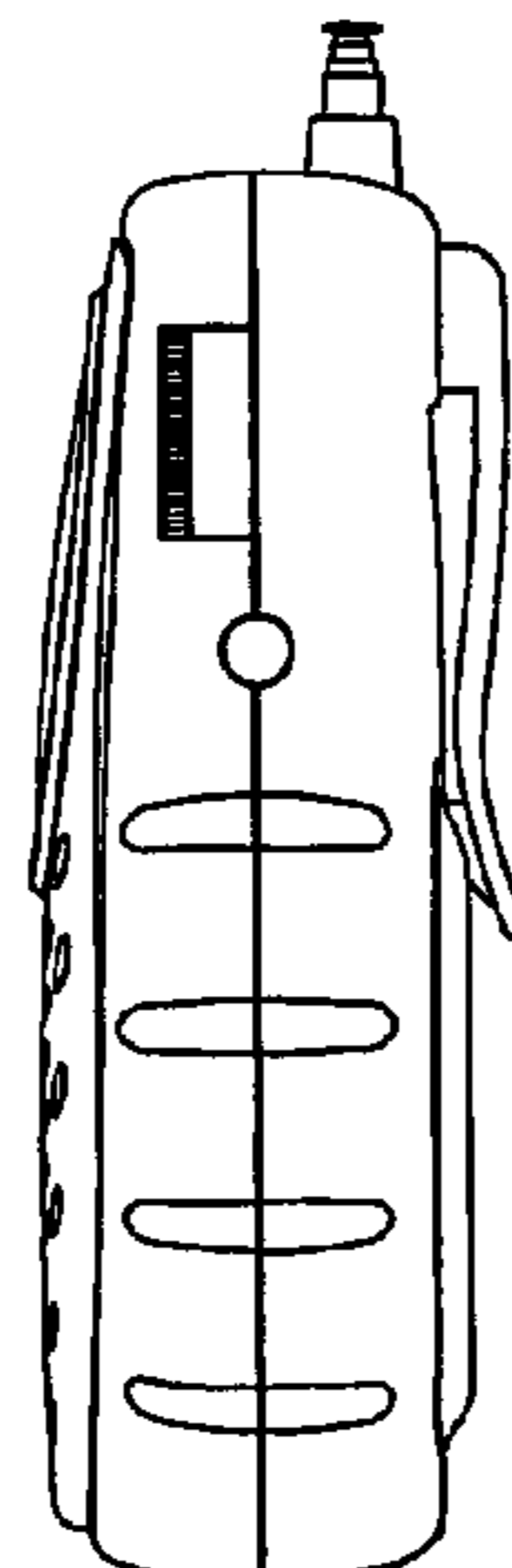
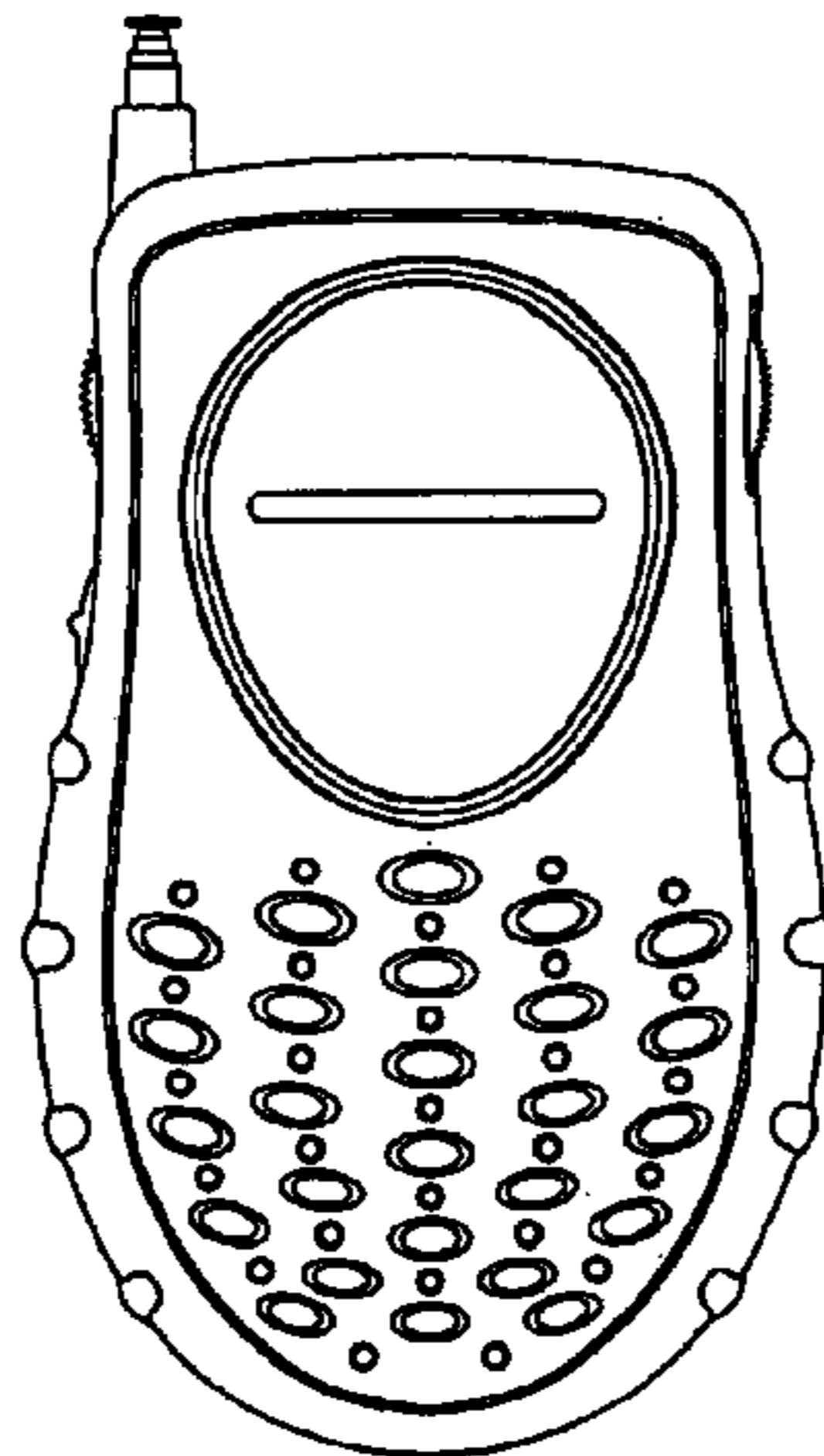

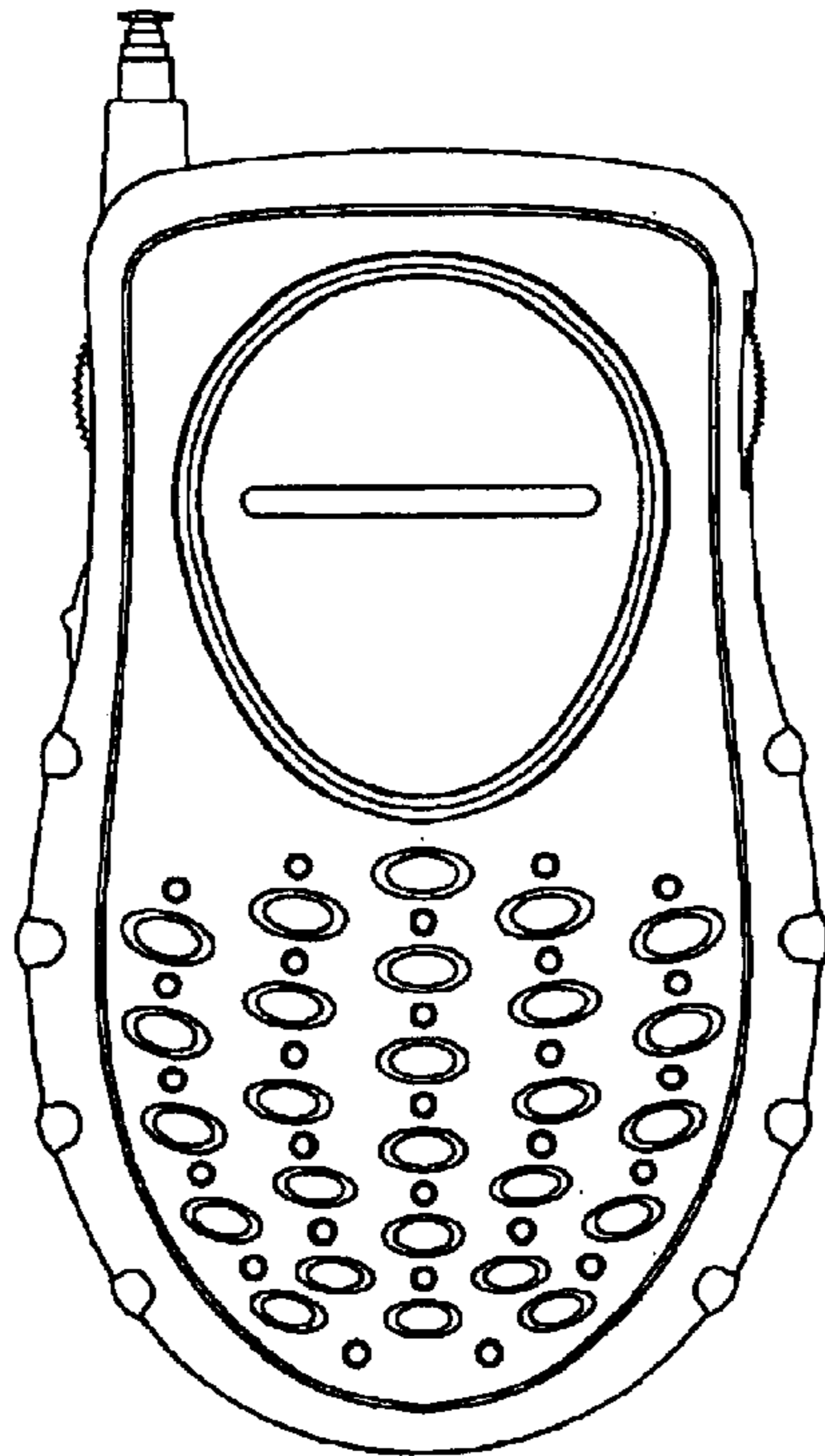

Fig. 1

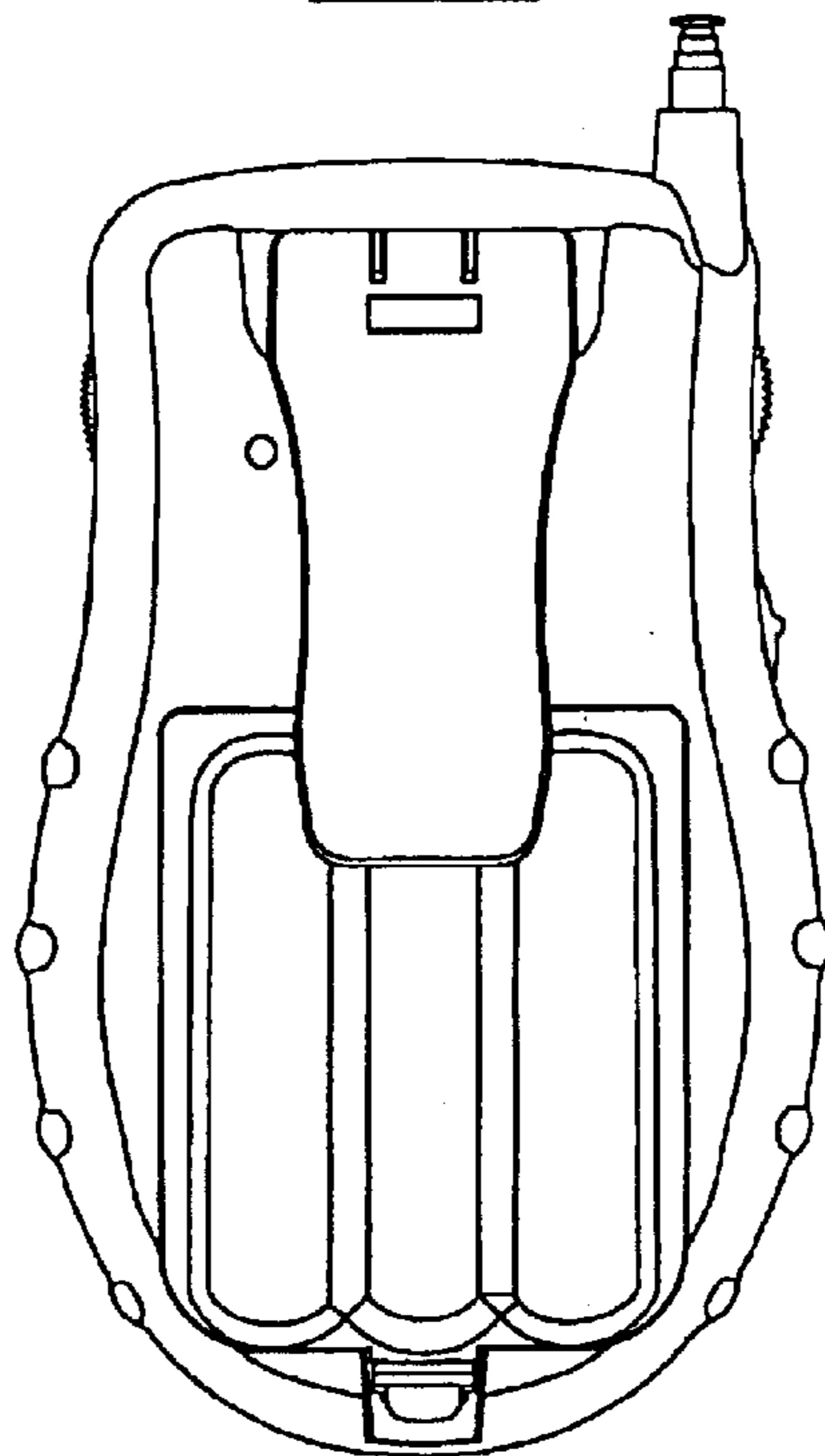

Fig. 2

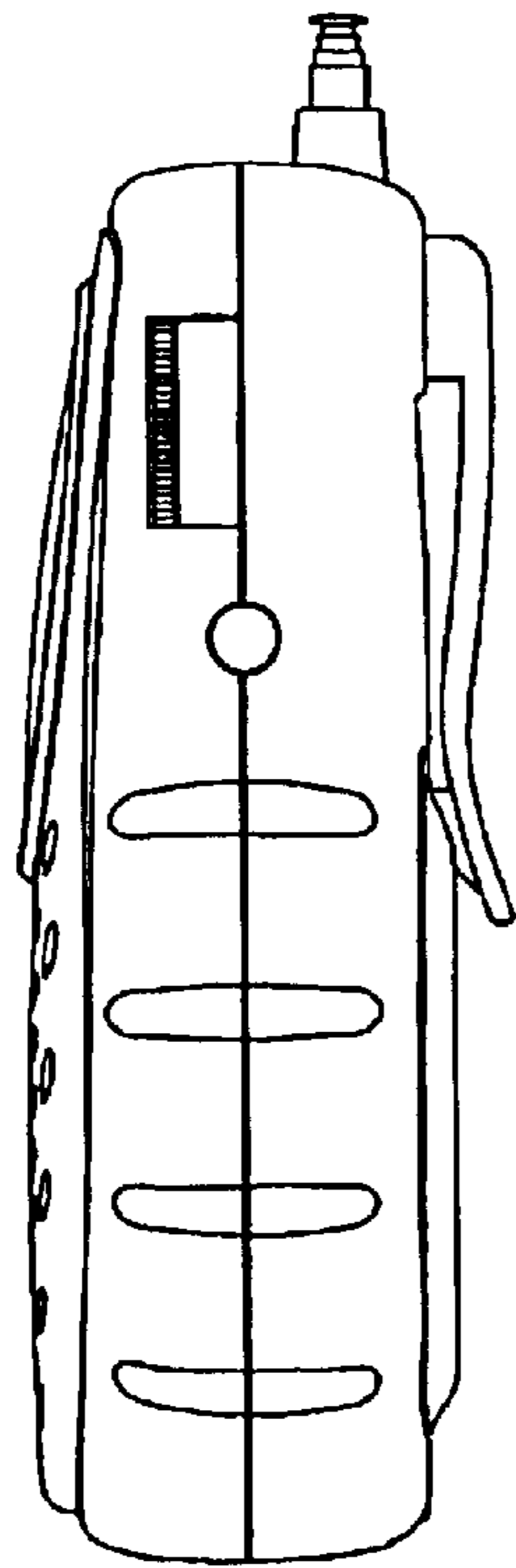

Fig. 3

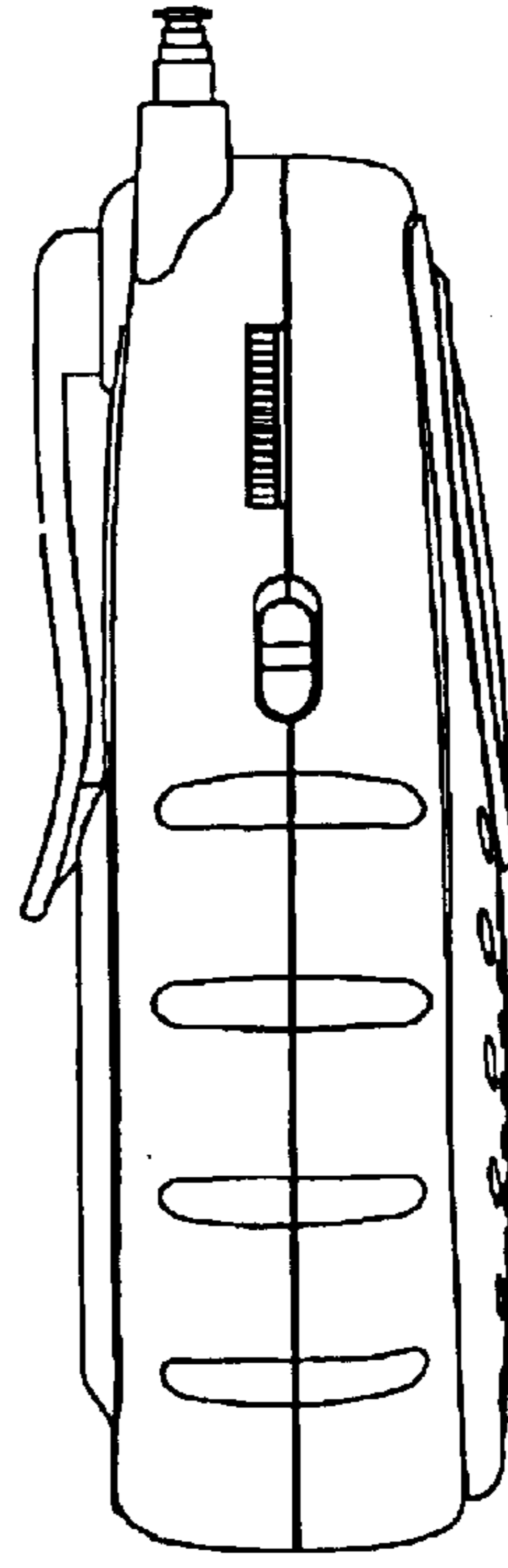

Fig. 4

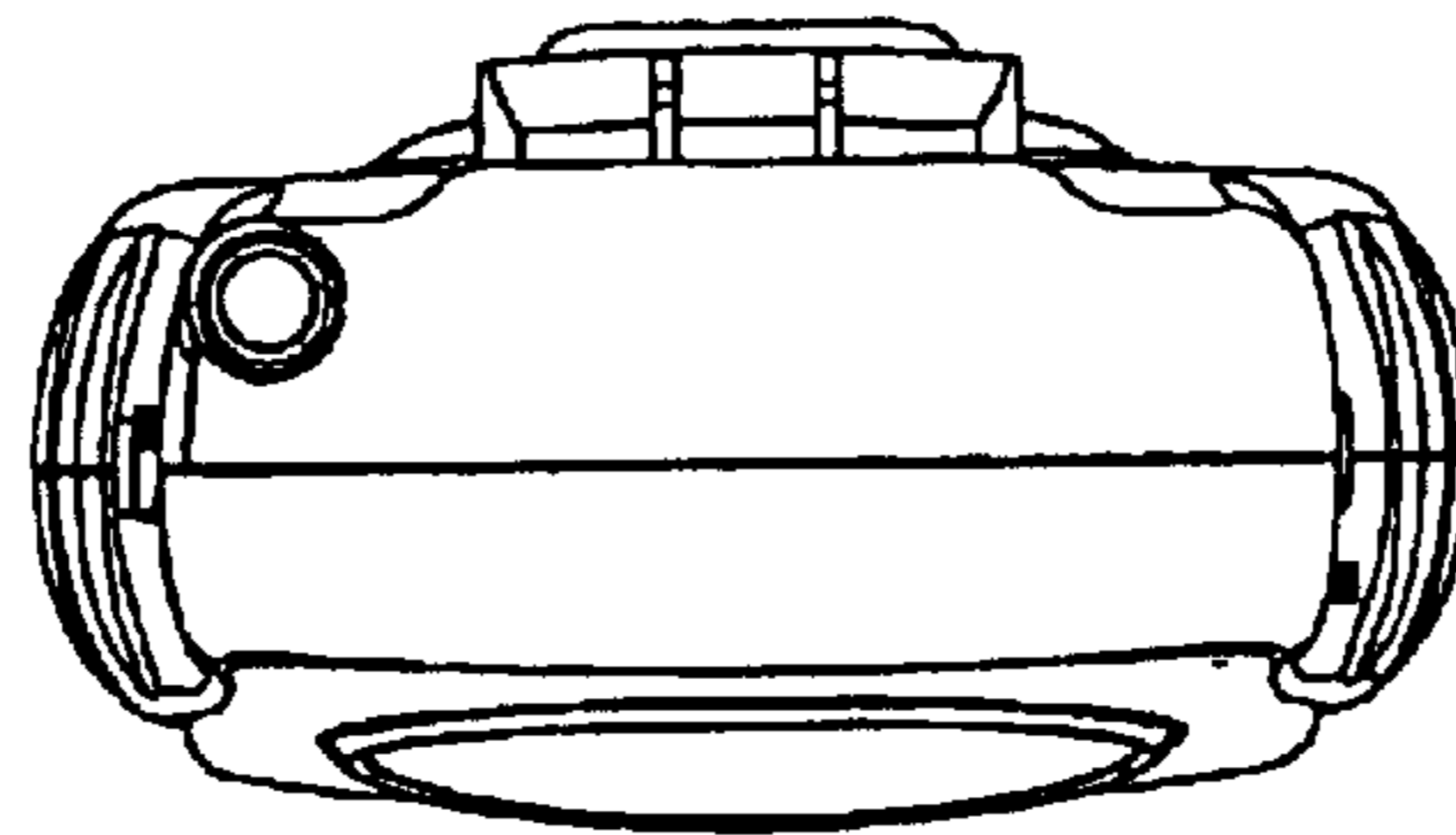

Fig. 5

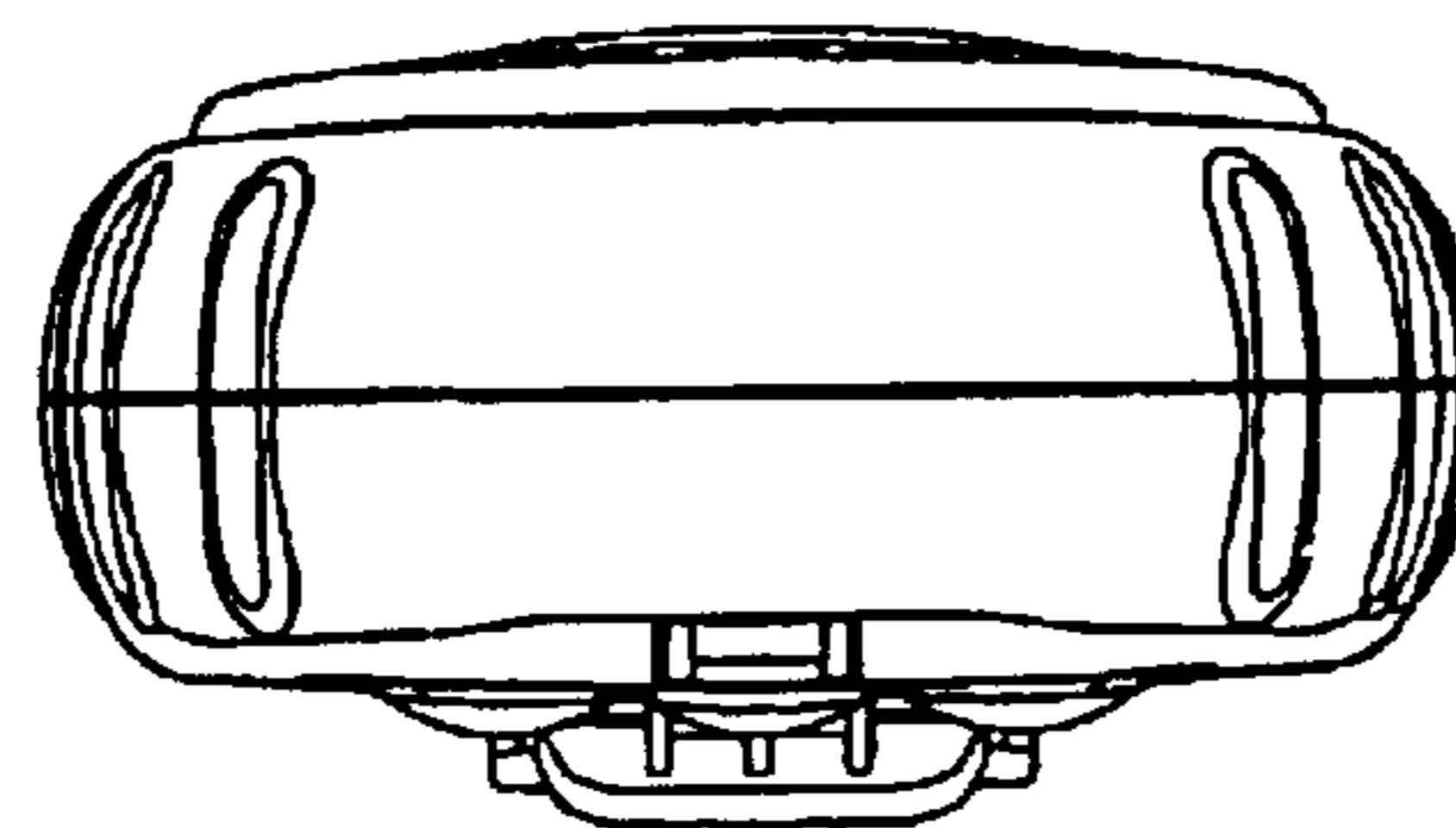

Fig. 6