



US00D500358S

(12) **United States Design Patent**
Haug et al.

(10) **Patent No.: US D500,358 S**
(45) **Date of Patent: ** Dec. 28, 2004**

(54) **SHOWER UNIT**

D457,611 S * 5/2002 Haug et al. D23/304

(75) Inventors: **Andreas Haug**, Stuttgart (DE); **Tom Schönherr**, Stuttgart (DE); **Andreas Dimitriadis**, Lorch (DE)

(73) Assignee: **Hansgrohe AG**, Schiltach (DE)

(**) Term: **14 Years**

(21) Appl. No.: **29/182,464**

(22) Filed: **May 28, 2003**

(30) **Foreign Application Priority Data**

Nov. 29, 2002 (DE) 402 09 958

(51) **LOC (7) Cl.** **23-02**

(52) **U.S. Cl.** **D23/304**

(58) **Field of Search** D23/270, 275,
D23/279, 283, 303, 304; 4/552, 605, 596-597,
615

(56) **References Cited**

U.S. PATENT DOCUMENTS

D447,547 S * 9/2001 Dimitriadis et al. D23/304
D457,610 S * 5/2002 Haug et al. D23/304

OTHER PUBLICATIONS

Duscholux brochure "Produktverzeichnis", pp. 52 and 53, Feb., 2002.

Newteam catalog "The Shower Centres", 2 pages, 1997.

* cited by examiner

Primary Examiner—Robert A. Delehanty

(74) *Attorney, Agent, or Firm*—Duane Morris LLP

(57) **CLAIM**

The ornamental design for a shower unit, as shown and described.

DESCRIPTION

FIG. 1: is a side perspective view of the shower unit showing our new design;

FIG. 2: is a top plan view thereof;

FIG. 3: is a bottom plan view thereof;

FIG. 4: is a side elevation view thereof;

FIG. 5: is a front elevation view thereof;

FIG. 6: is the opposite side elevation view thereof; and,

FIG. 7: is a rear elevation view thereof.

1 Claim, 3 Drawing Sheets

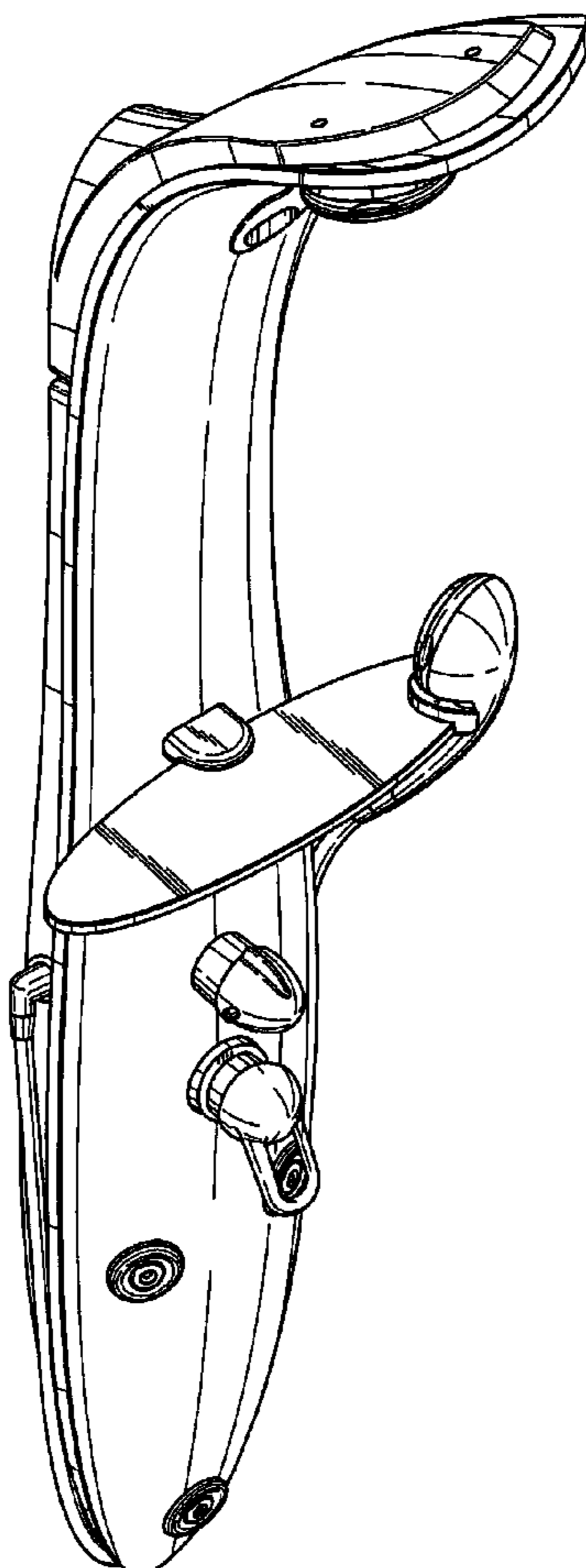

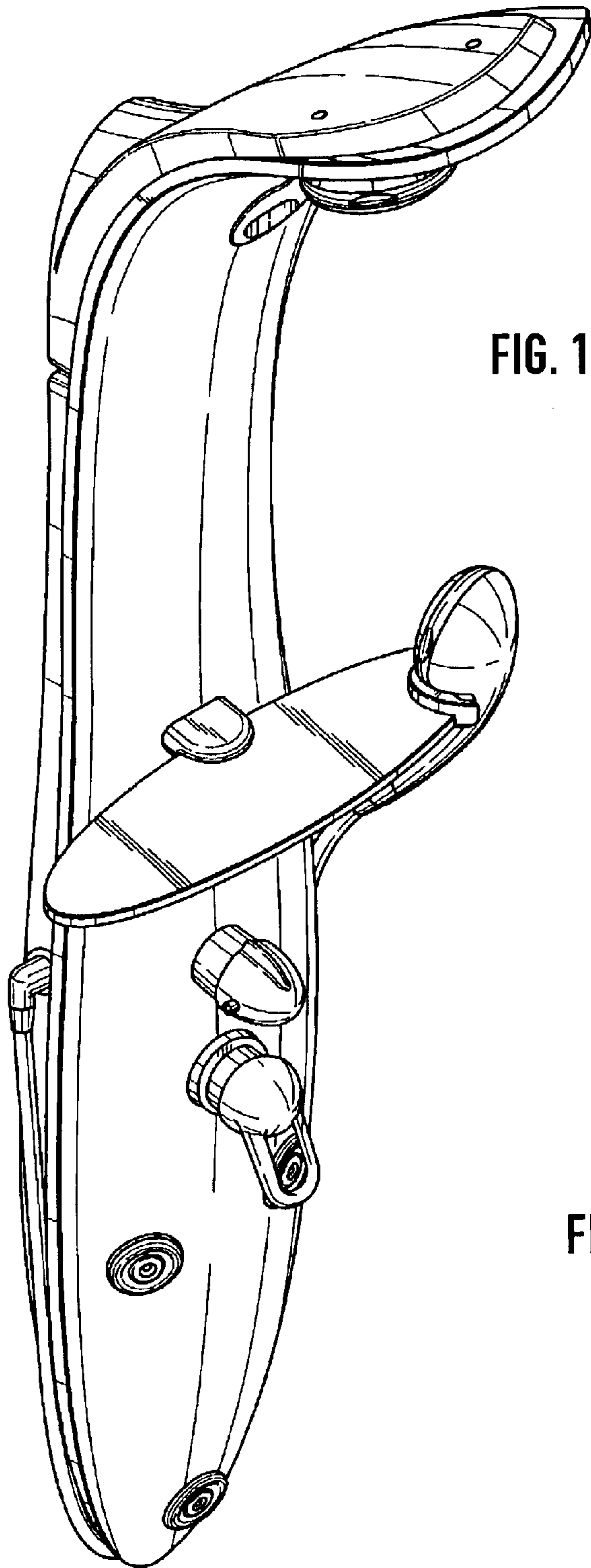

FIG. 1

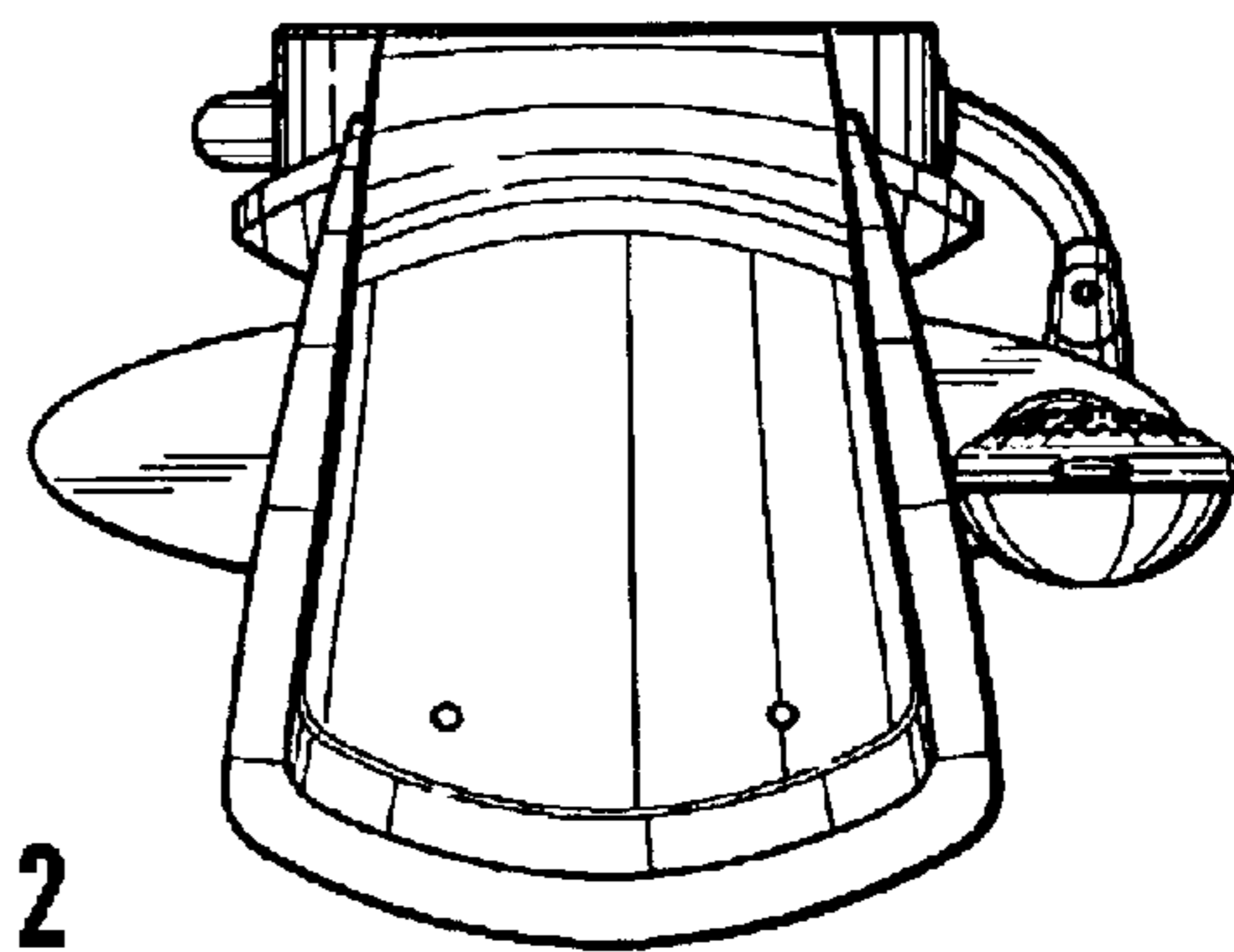

FIG. 2

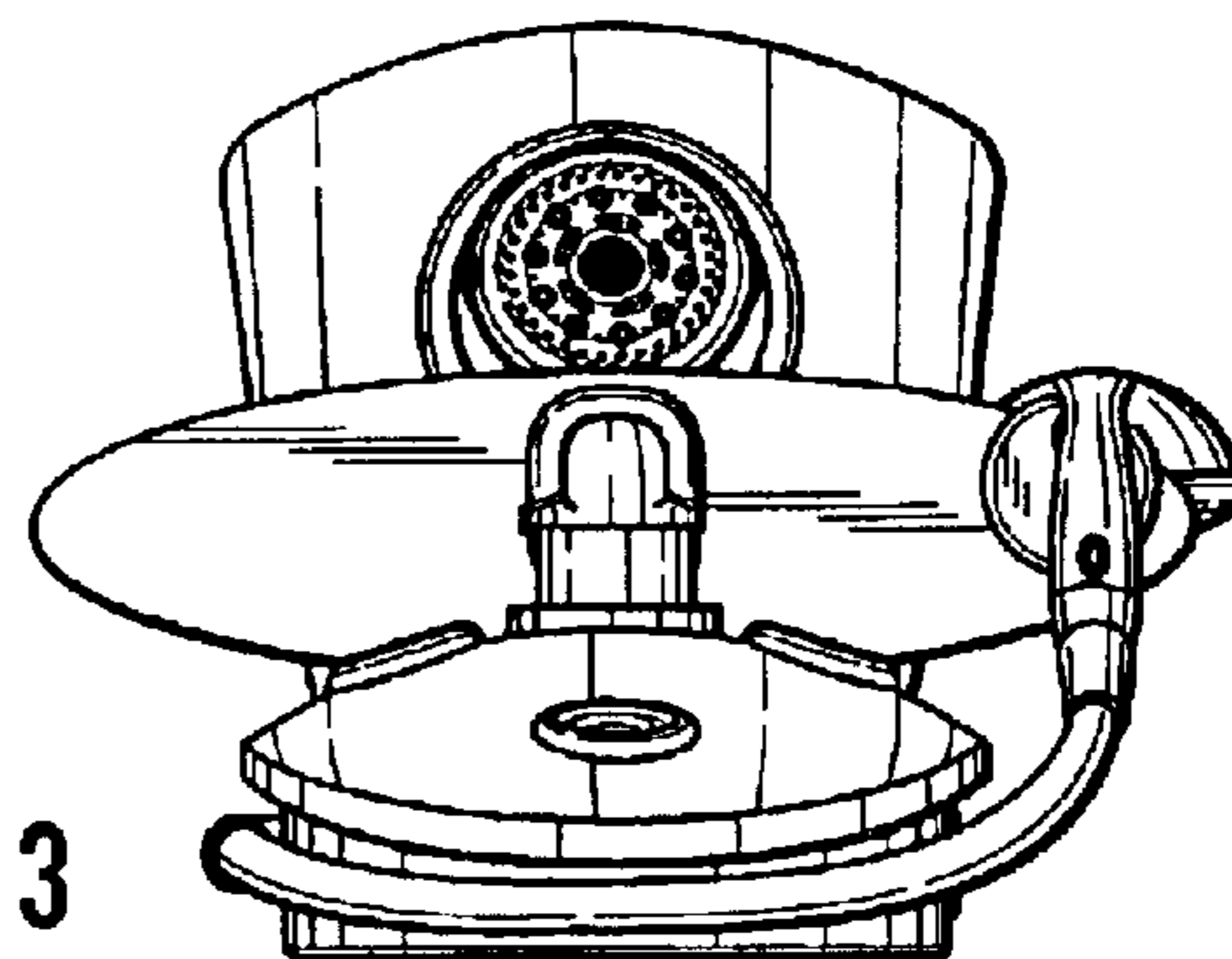

FIG. 3

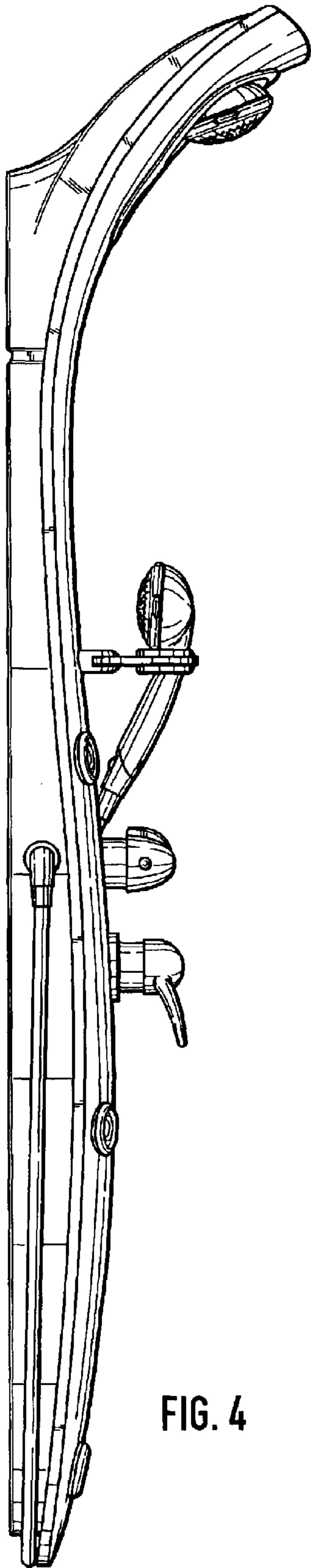

FIG. 4

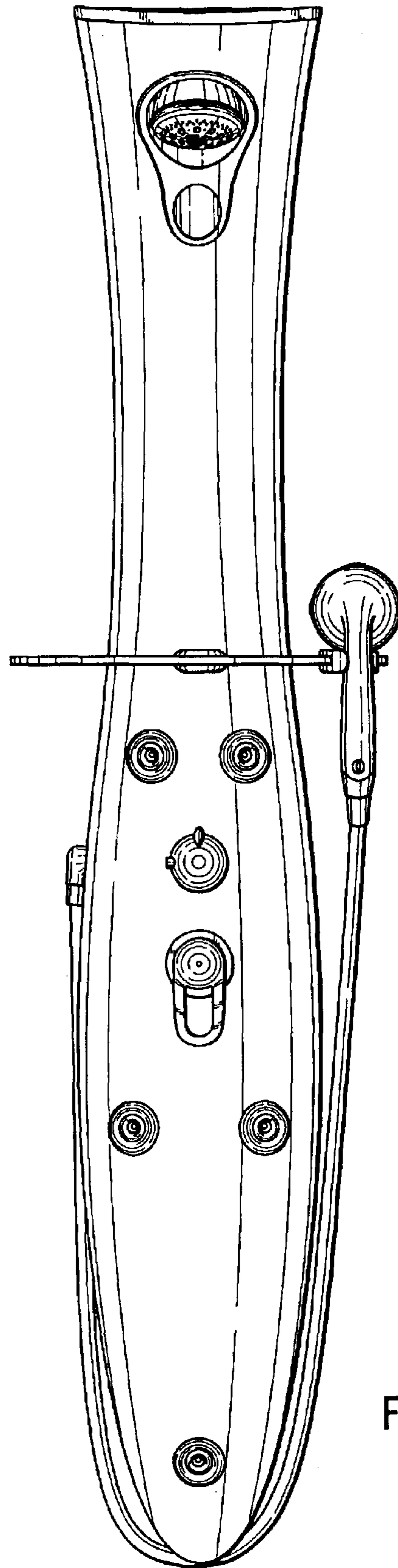

FIG. 5

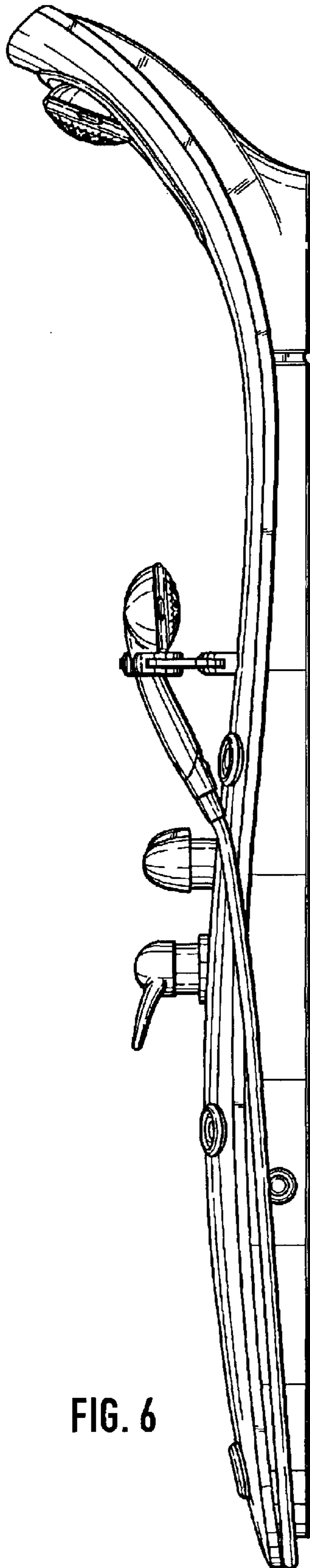

FIG. 6

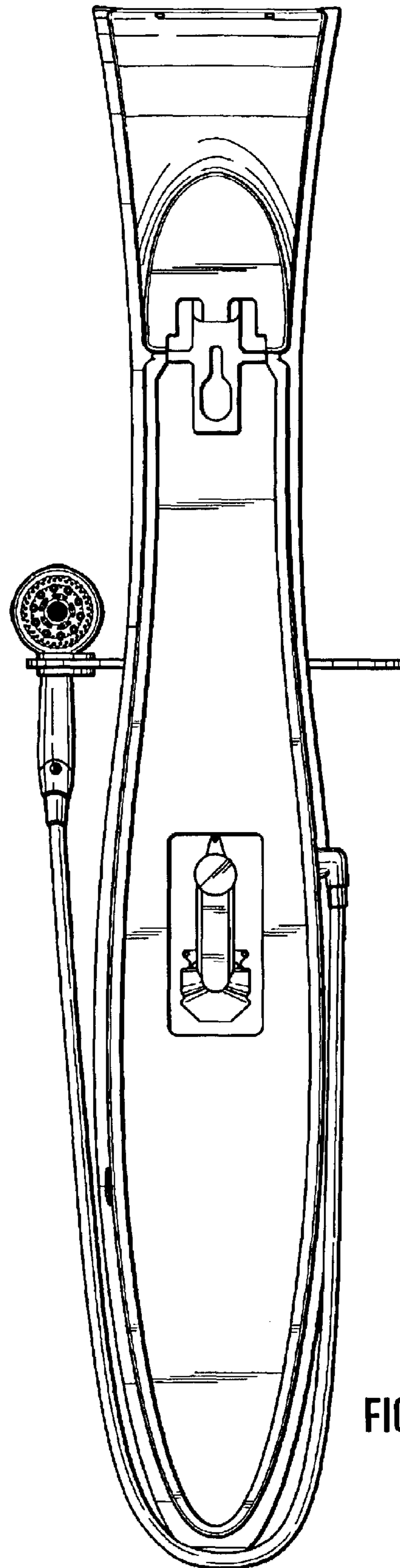

FIG. 7