

US00D500337S

(12) **United States Design Patent**  
**Tsuchida**

(10) **Patent No.:** **US D500,337 S**  
(45) **Date of Patent:** **\*\* Dec. 28, 2004**

(54) **COMBINED BALL-POINT PEN AND CORRECTION TAPE DISPENSER**

(75) Inventor: **Masayuki Tsuchida**, Tokyo (JP)

(73) Assignee: **Kabushiki Kaisha Pilot Corporation**, Tokyo (JP)

(\*\*) Term: **14 Years**

(21) Appl. No.: **29/200,534**

(22) Filed: **Mar. 2, 2004**

(30) **Foreign Application Priority Data**

Sep. 3, 2003 (JP) ..... 2003-025776

(51) **LOC (7) Cl.** ..... **19-06**

(52) **U.S. Cl.** ..... **D19/36; D19/55; D19/56; D19/53; D19/69**

(58) **Field of Search** ..... D19/35, 36, 41-51, D19/53-58, 65, 66, 67-69, 81-85; 401/17, 18, 21, 29-34, 52, 195, 6, 7, 88; 156/523, 527, 577, 327; 242/588, 588.1, 588.2-588.6

(56) **References Cited**

**U.S. PATENT DOCUMENTS**

D408,854 S \* 4/1999 Katami ..... D19/51  
6,024,104 A \* 2/2000 Dolberry ..... 401/195

(List continued on next page.)

*Primary Examiner*—Martie K. Holtje

(74) *Attorney, Agent, or Firm*—Sughrue Mion, PLLC

(57) **CLAIM**

The ornamental design for a combined ball-point pen and correction tape dispenser, as shown and described.

**DESCRIPTION**

FIG. 1 is a top, left front perspective view of a combined ball-point pen and correction tape dispenser showing my new design;

FIG. 2 is a front elevational view thereof;

FIG. 3 is a right side elevational view thereof;

FIG. 4 is a rear elevational view thereof;

FIG. 5 is a left side elevational view thereof;

FIG. 6 is a top plan view thereof;

FIG. 7 is a bottom plan view thereof;

FIG. 8 is a cross-sectional view thereof taken in the direction of arrows 8—8 in FIG. 5;

FIG. 9 is an enlarged cross-sectional view thereof taken in the direction of arrows 9—9 in FIG. 5;

FIG. 10 is an enlarged cross-sectional view taken in the direction of arrows 10—10 in FIG. 5;

FIG. 11 is a front elevational view thereof, with the cap member removed for ease of illustration;

FIG. 12 is a right side elevational view of FIG. 11;

FIG. 13 is a rear elevational view of FIG. 11;

FIG. 14 is a left side elevational view of FIG. 11;

FIG. 15 is a top plan view of FIG. 11;

FIG. 16 is a front elevational view of FIG. 2, with the cap member and the correction tape cartridge removed for ease of illustration;

FIG. 17 is a right side elevational view of FIG. 16;

FIG. 18 is a rear elevational view of FIG. 16;

FIG. 19 is a left side elevational view of FIG. 16;

FIG. 20 is a top plan view of FIG. 16;

FIG. 21 is a front elevational view of the correction tape cartridge shown separately for ease of illustration;

FIG. 22 is a right side elevational view of FIG. 21;

FIG. 23 is a rear elevational view of FIG. 21;

FIG. 24 is a left side elevational view of FIG. 21;

FIG. 25 is a top plan view of FIG. 21;

FIG. 26 is a bottom plan view of FIG. 21;

FIG. 27 is a top plan view of the cap member shown separately for ease of illustration;

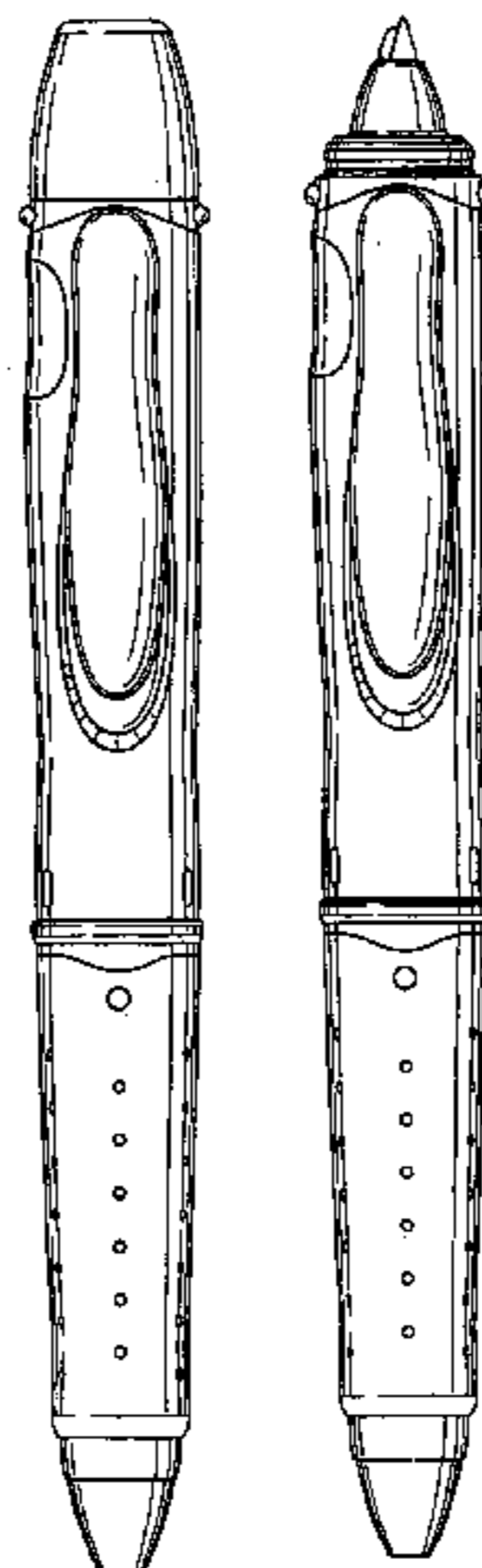
FIG. 28 is a typical side elevational view of FIG. 27;

FIG. 29 is a bottom plan view of FIG. 27;

FIG. 30 is a left side elevational view of FIG. 1 with the writing tip in an extended position; and,

FIG. 31 is reference view showing the correction tape dispenser portion in an in-use position, the broken lines being employed for illustrative purposes only and forming no part of the claimed design.

**1 Claim, 10 Drawing Sheets**



# US D500,337 S

Page 2

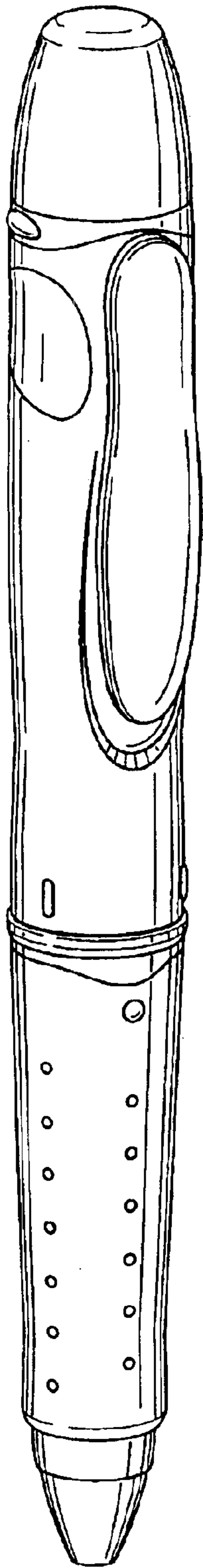
---

## U.S. PATENT DOCUMENTS

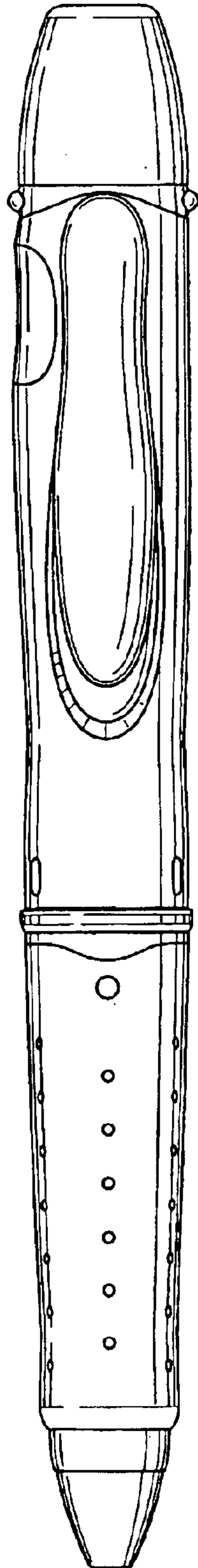
6,276,859 B1 *	8/2001	Hsu	.....	401/195	6,582,514 B1 *	6/2003	Yang	.....	401/195
6,461,068 B1 *	10/2002	Holmes	.....	401/17	D484,187 S *	12/2003	Moon	.....	D19/51
D469,469 S *	1/2003	Schminke et al.	.....	D19/69	D491,986 S *	6/2004	Bain	.....	D19/69
D474,241 S *	5/2003	Hasegawa	.....	D19/51	D495,002 S *	8/2004	Sung	.....	D19/51

\* cited by examiner

*FIG. 1*



*FIG. 2*



*FIG. 3*

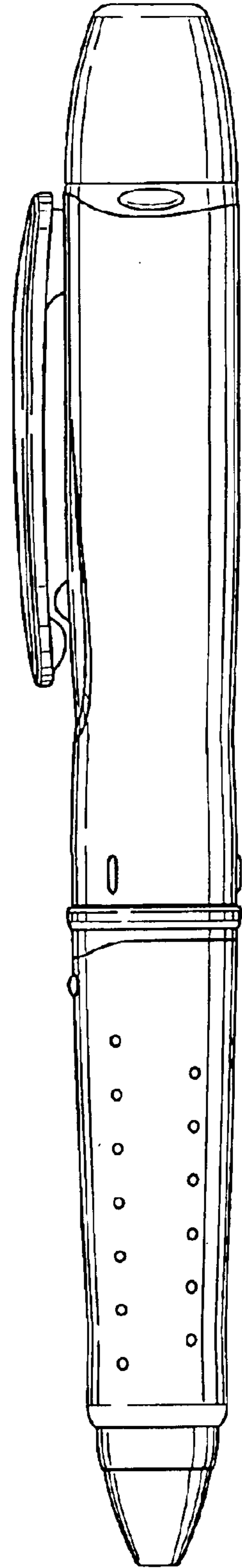


FIG. 4

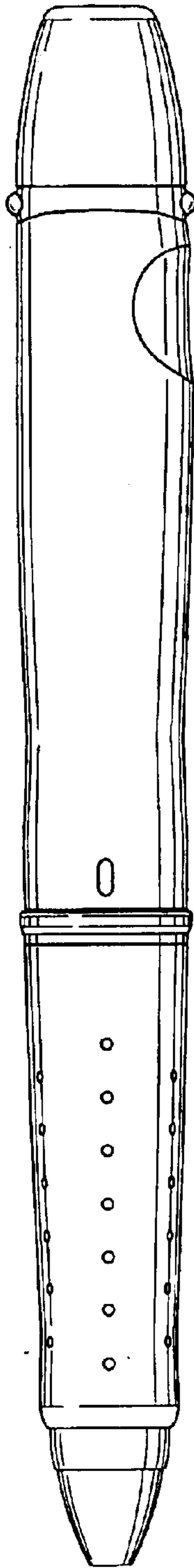


FIG. 5

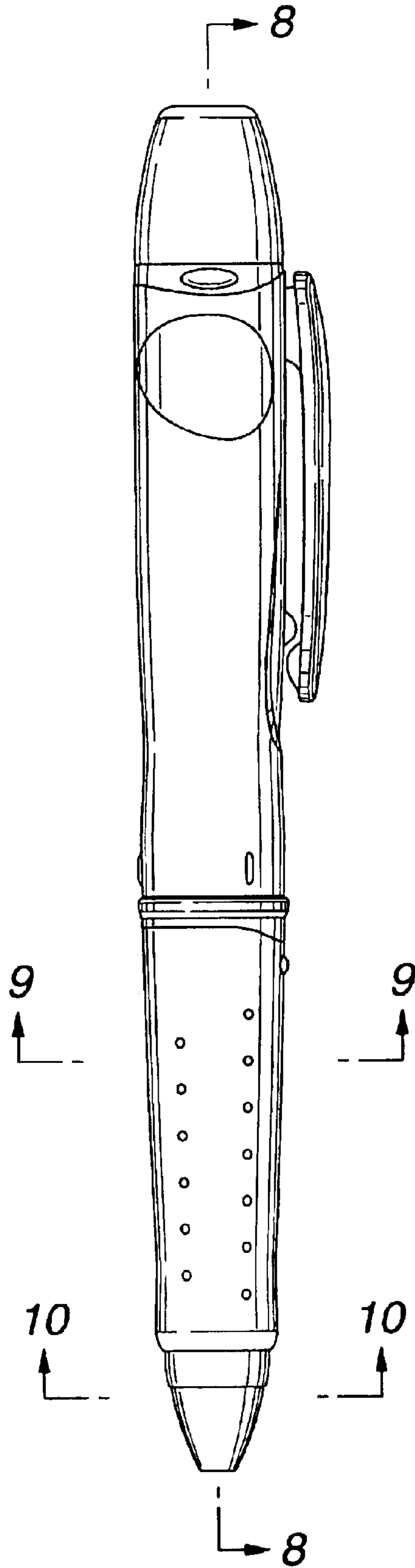


FIG. 6

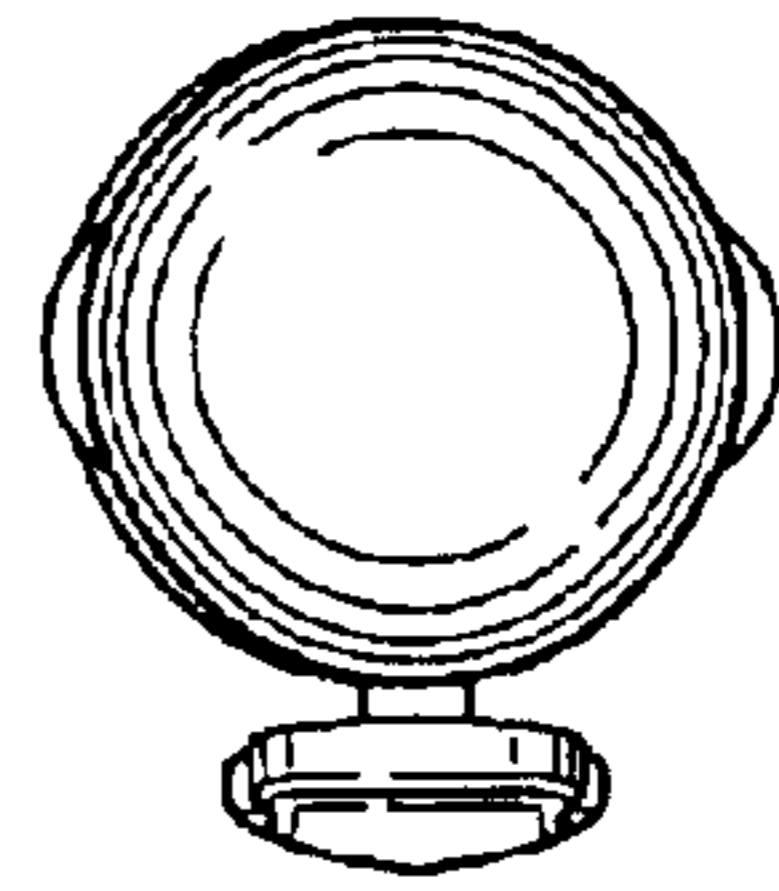
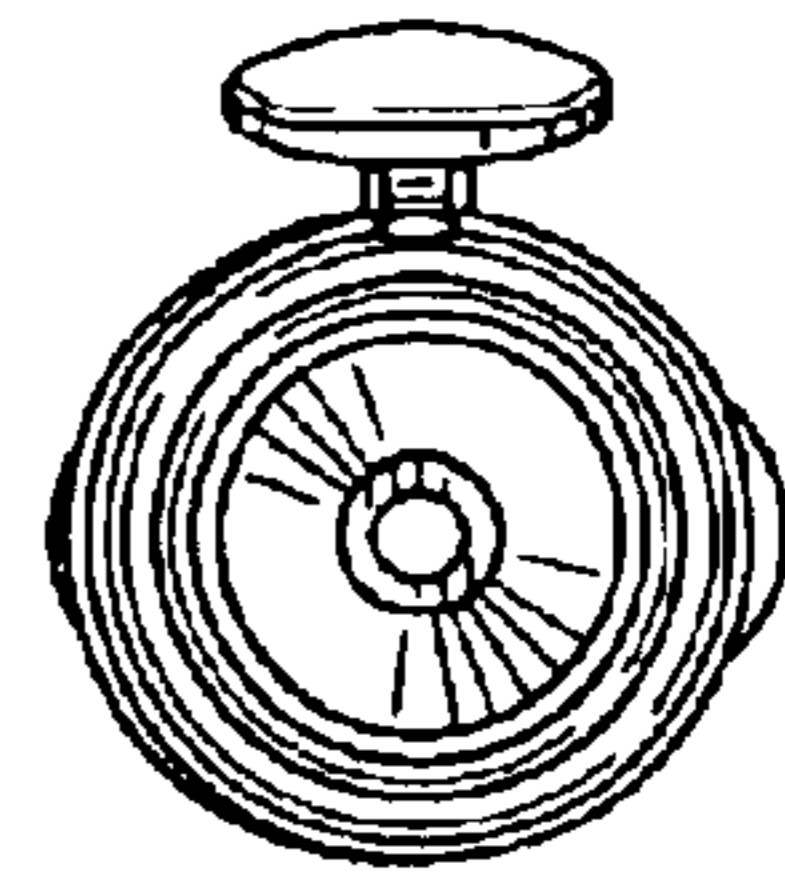
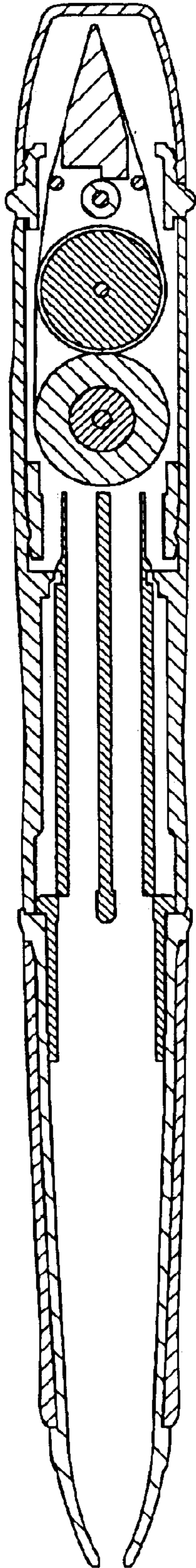


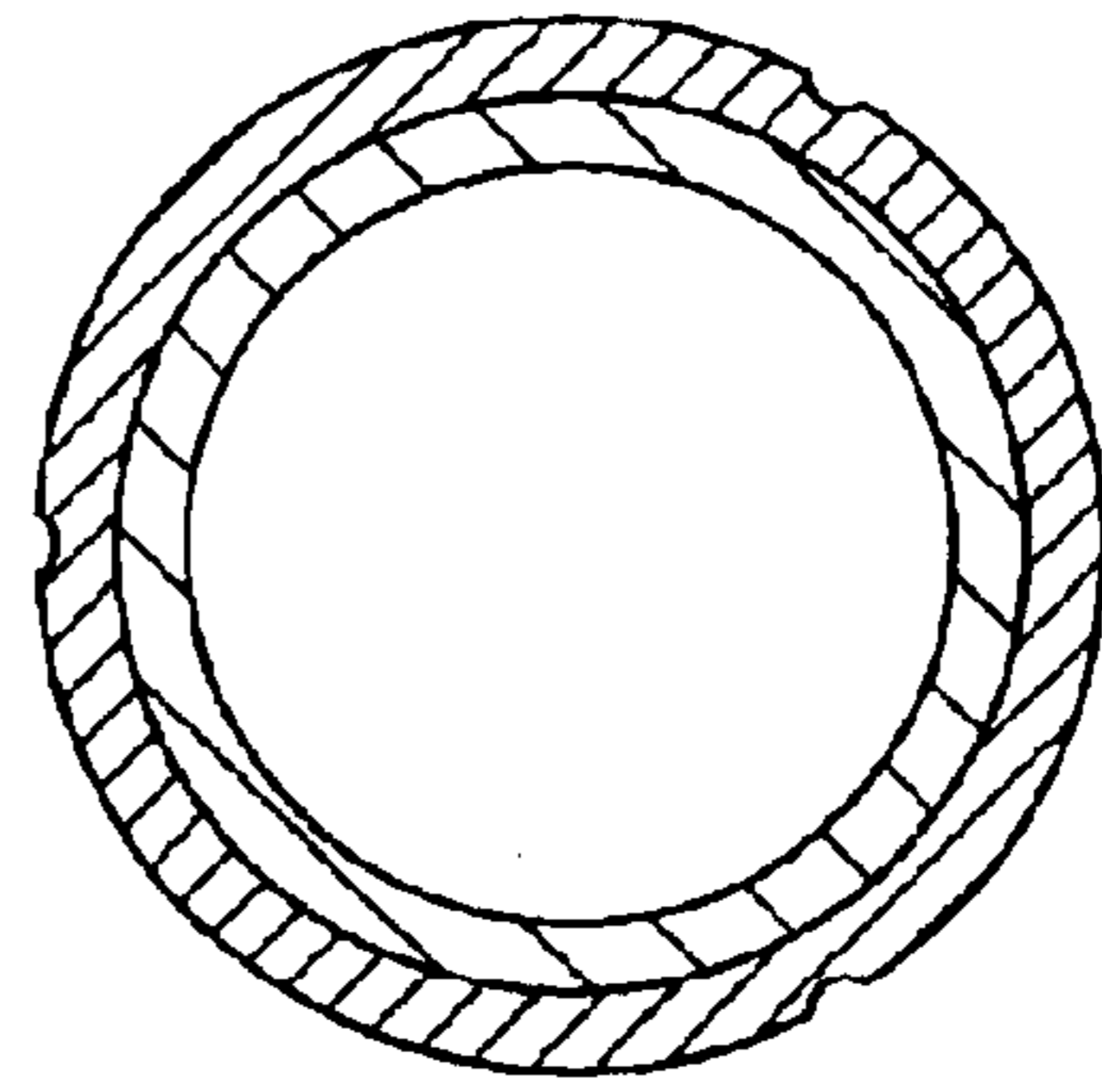
FIG. 7



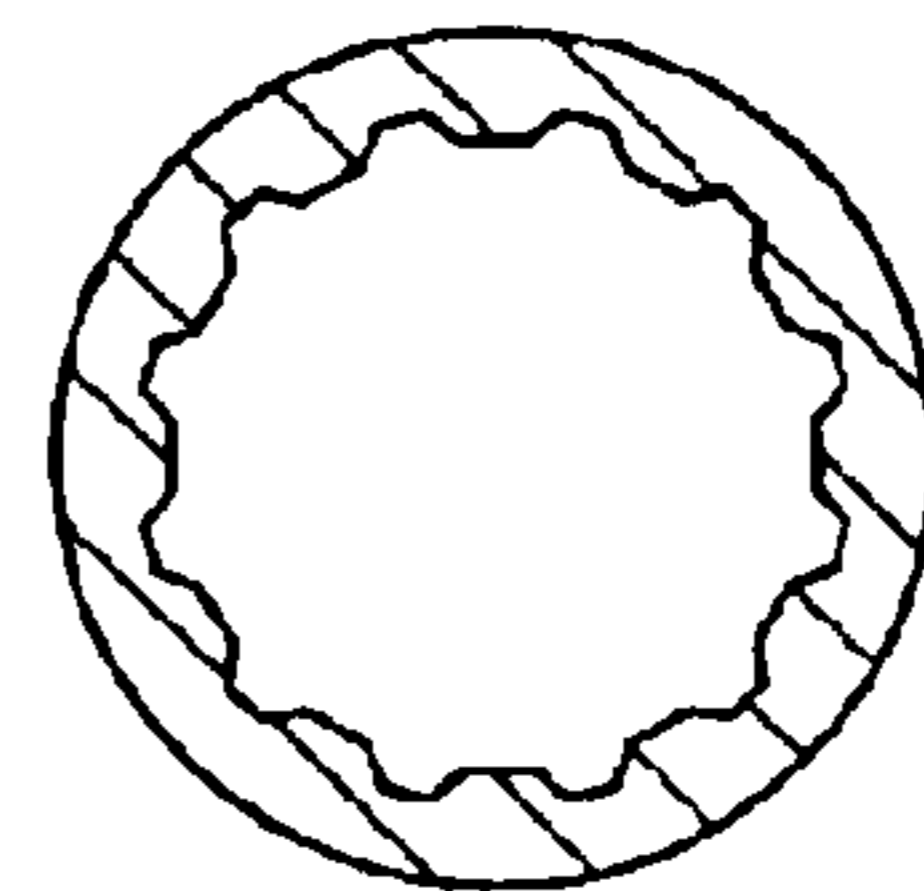
**FIG. 8**



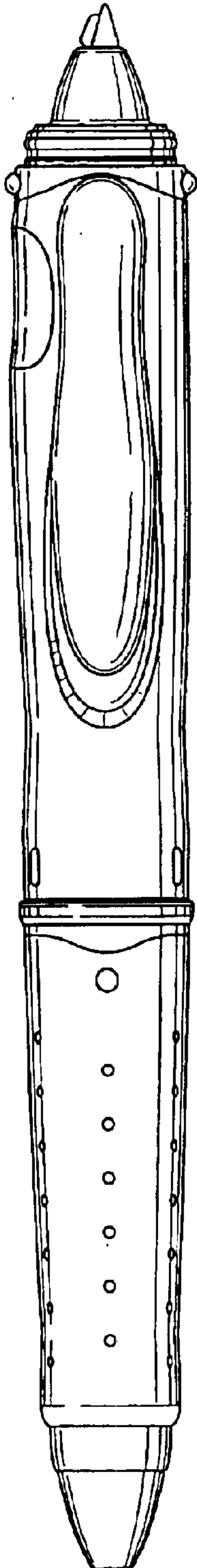
**FIG. 9**



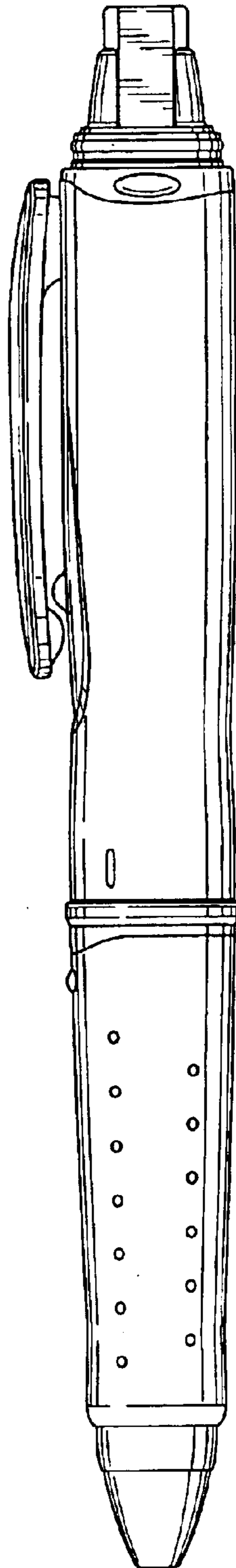
**FIG. 10**



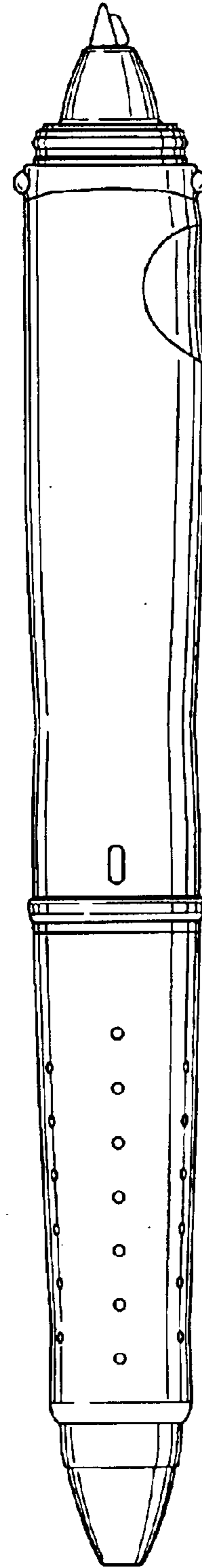
*FIG. 11*



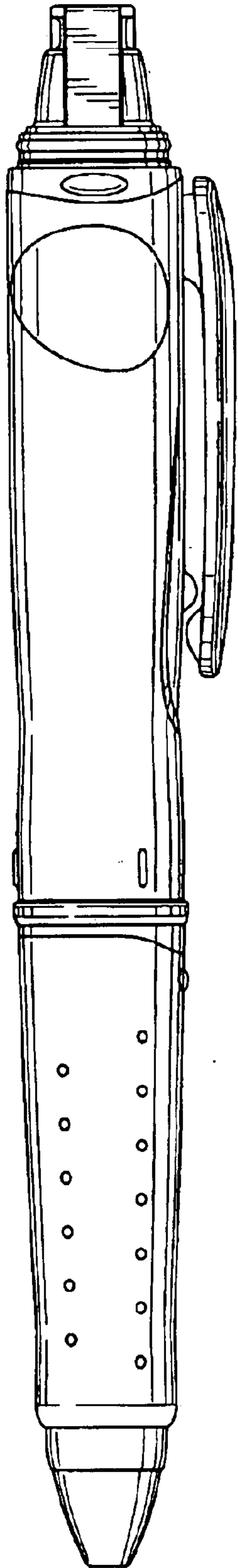
*FIG. 12*



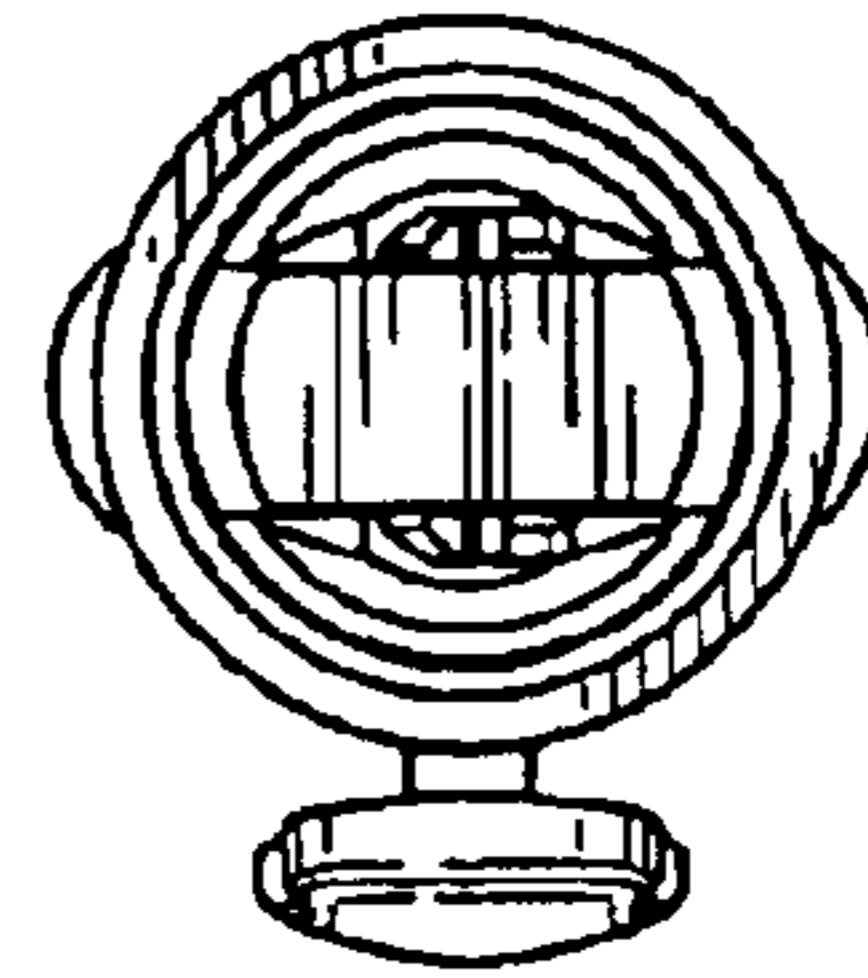
*FIG. 13*



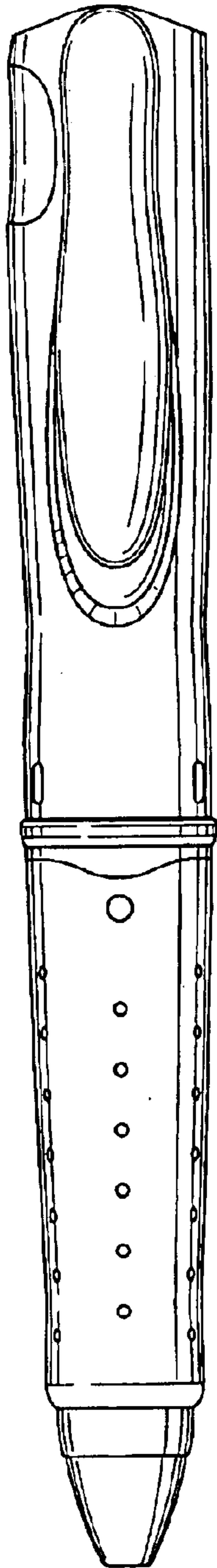
*FIG. 14*



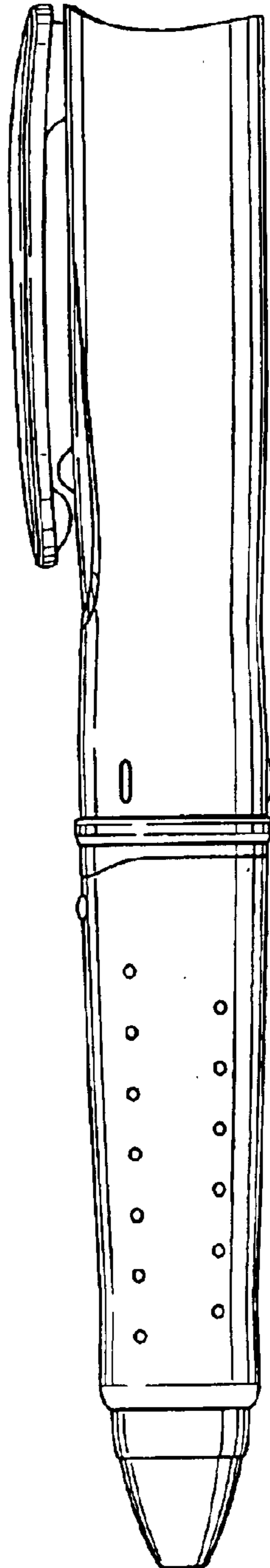
*FIG. 15*



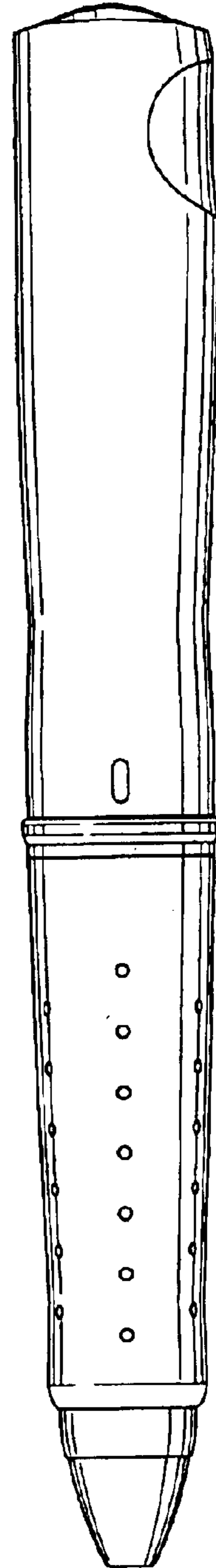
*FIG. 16*



*FIG. 17*

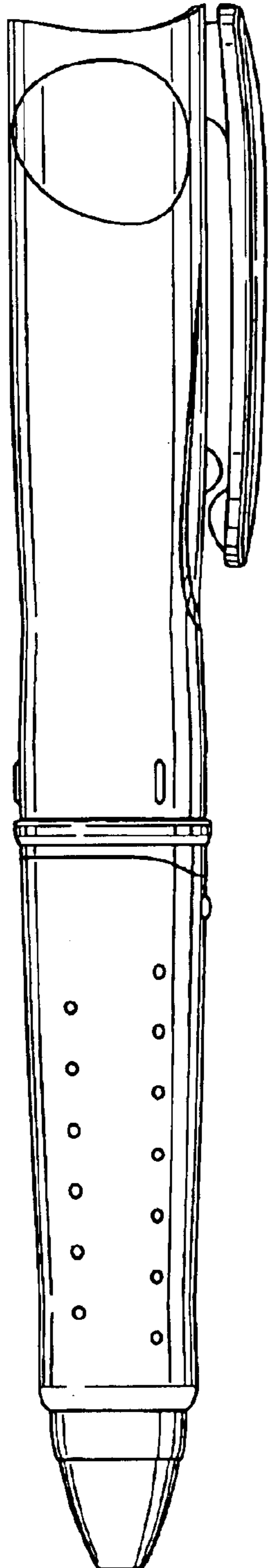


*FIG. 18*

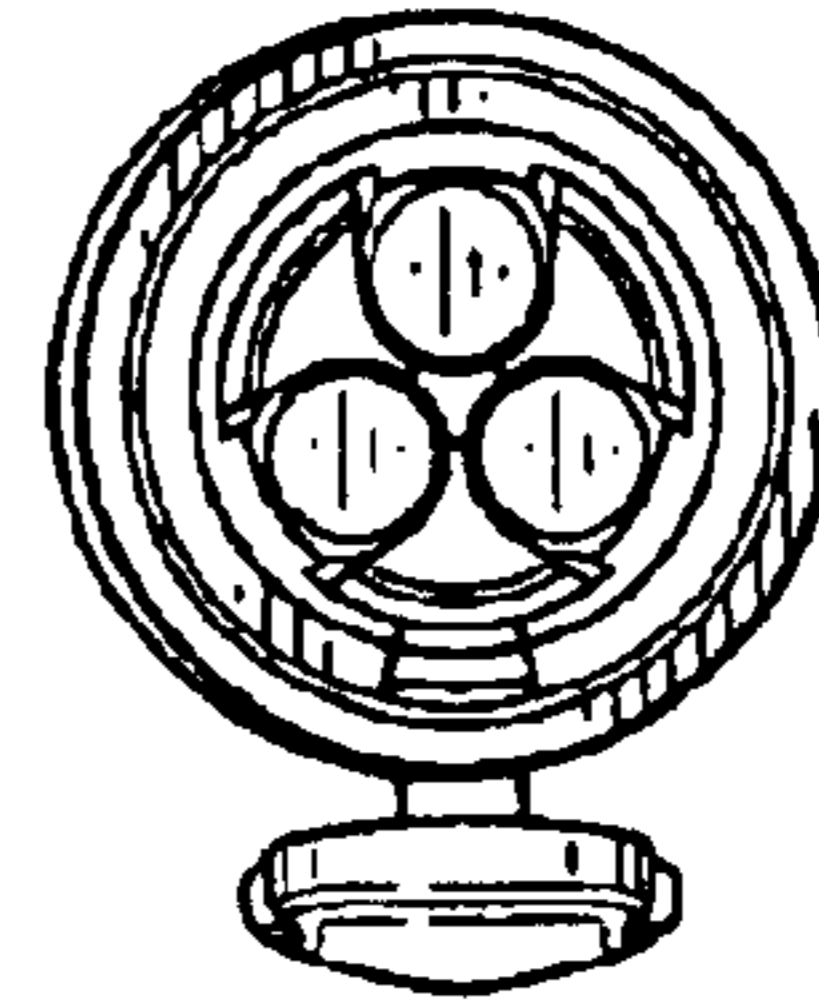




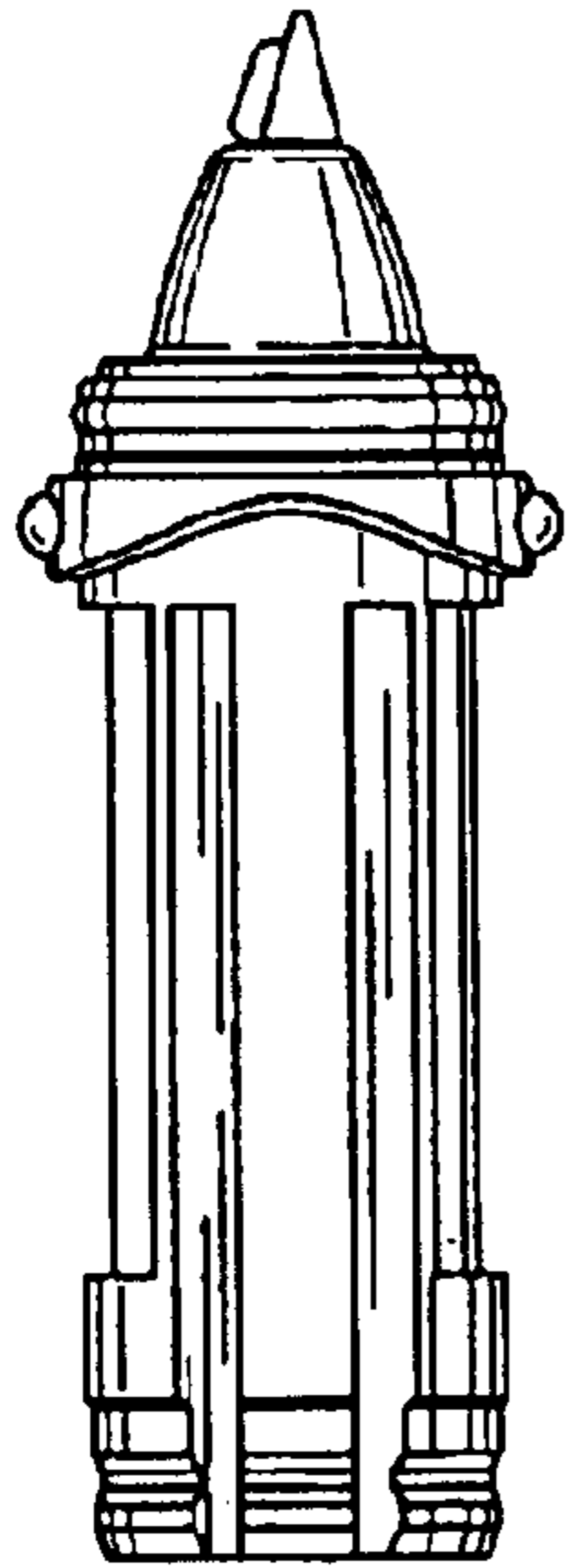
*FIG. 19*



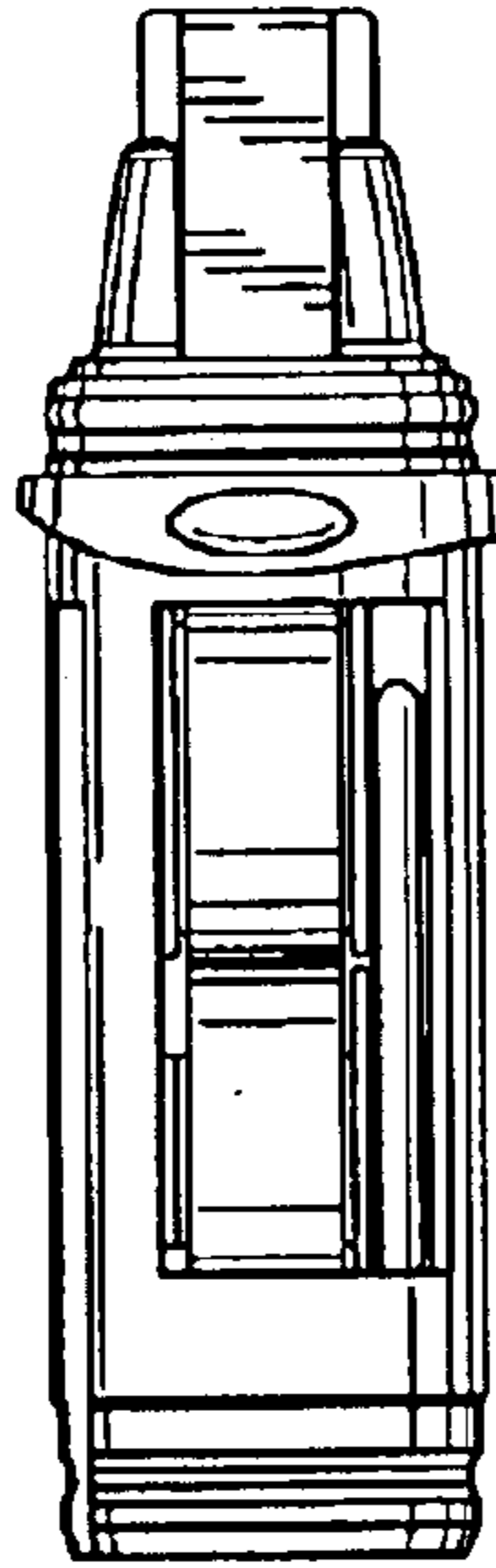
*FIG. 20*



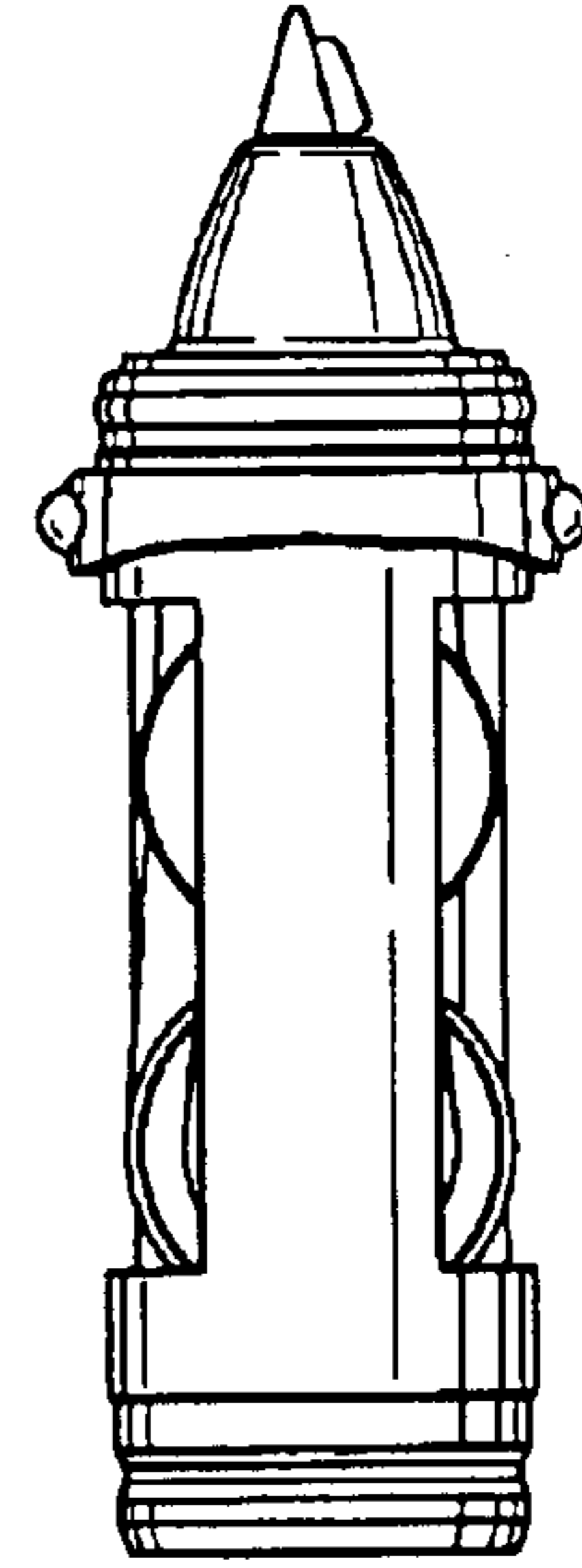
*FIG. 21*



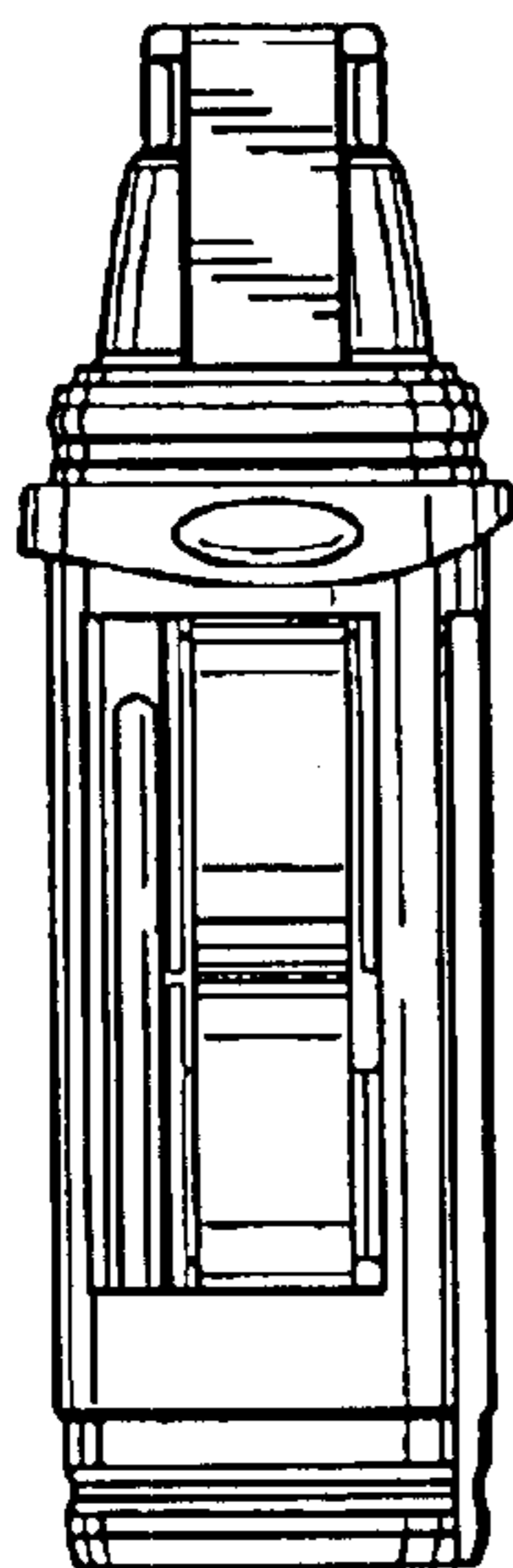
*FIG. 22*



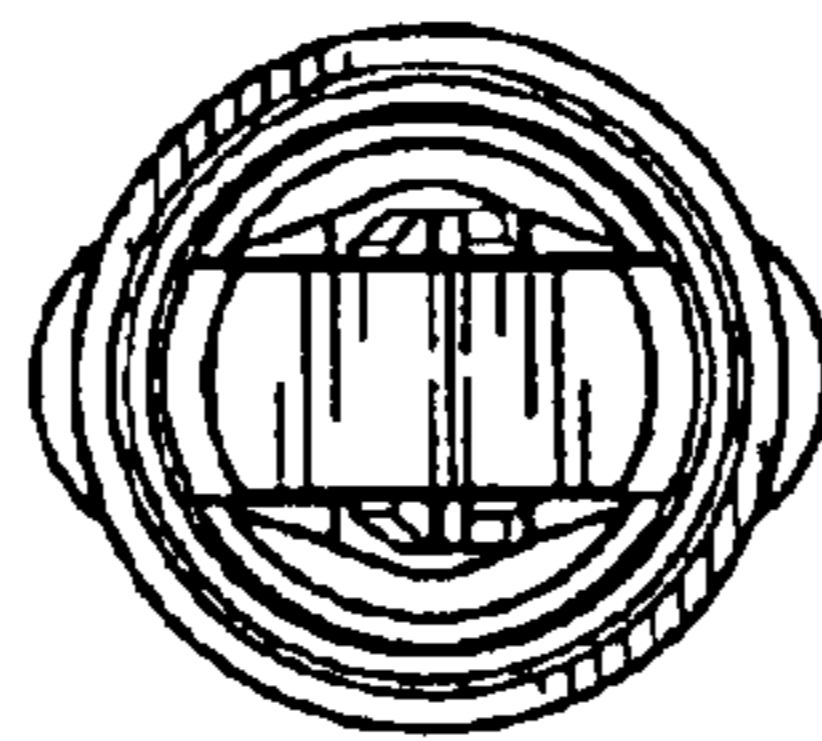
*FIG. 23*



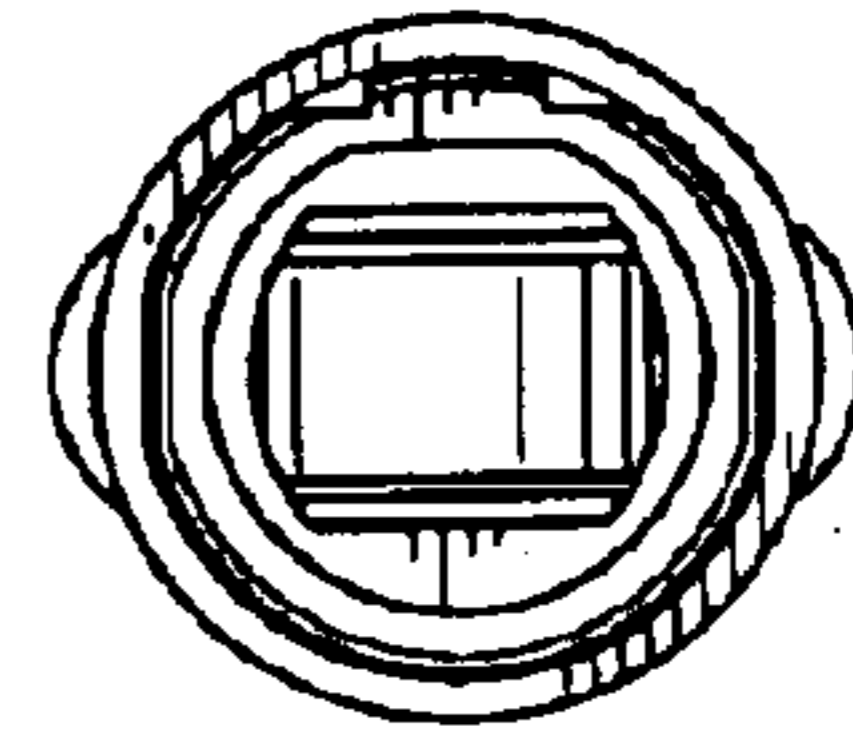
*FIG. 24*



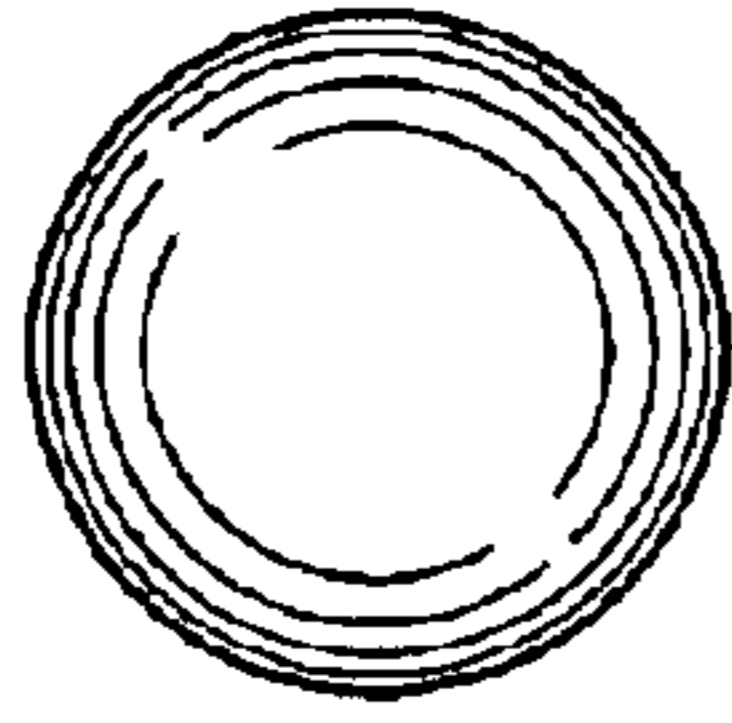
*FIG. 25*



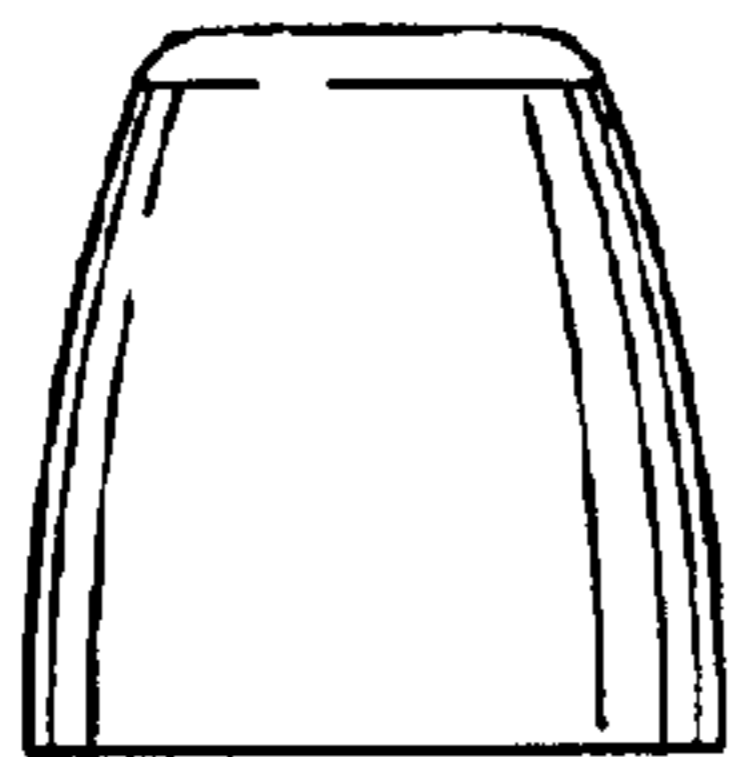
*FIG. 26*



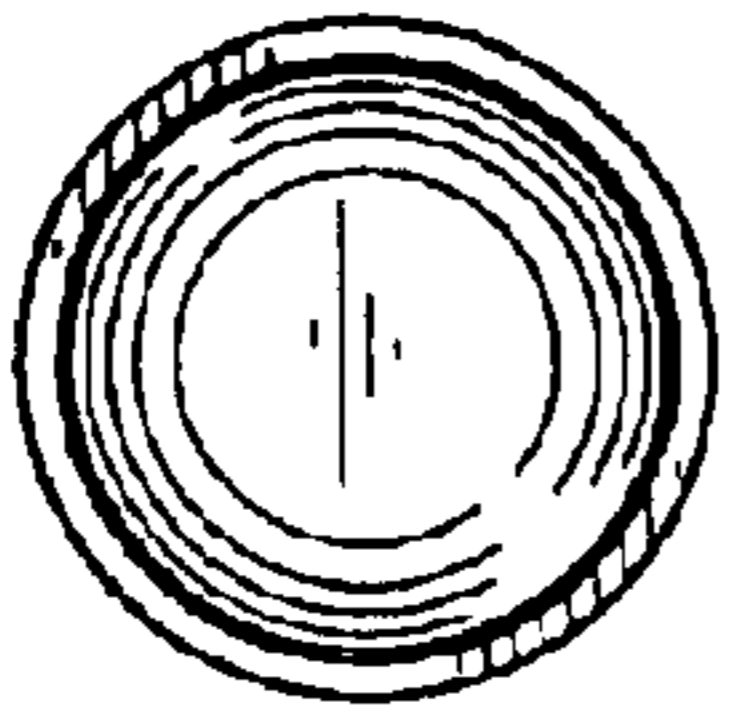
*FIG. 27*



*FIG. 28*



*FIG. 29*



*FIG. 30*

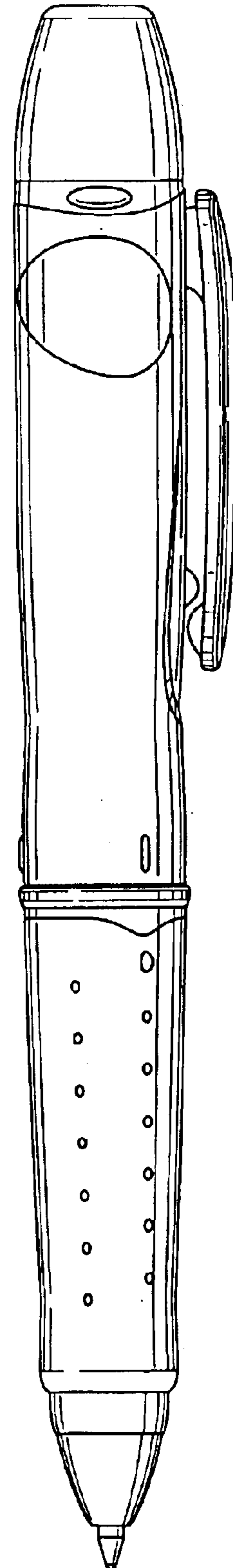


FIG. 31

