



US00D500257S

(12) **United States Design Patent**  
**Hutchison et al.**

(10) **Patent No.: US D500,257 S**  
(45) **Date of Patent: \*\* Dec. 28, 2004**

(54) **HANDHELD BIOTHREAT DETECTOR**

(75) Inventors: **Wesley H. Hutchison**, Bridgeville, PA (US); **Robert M. Stern**, Scottsdale, PA (US); **Patrick J. Treado**, Pittsburgh, PA (US)

(73) Assignee: **ChemImage Corporation**, Pittsburgh, PA (US)

(\*\*) Term: **14 Years**

(21) Appl. No.: **29/186,577**

(22) Filed: **Jul. 18, 2003**

(51) **LOC (7) Cl.** ..... **10-04**

(52) **U.S. Cl.** ..... **D10/81; D10/78**

(58) **Field of Search** ..... **D10/78, 81; 73/431; 204/403.01, 403.02; 205/777.5**

(56) **References Cited**

U.S. PATENT DOCUMENTS

2003/0159945 A1 \* 8/2003 Miyazaki et al. .... 205/777.5

\* cited by examiner

*Primary Examiner*—Antoine D. Davis

(74) *Attorney, Agent, or Firm*—Duane Morris LLP

(57) **CLAIM**

The ornamental design for a handheld biothreat detector, as shown and described.

**DESCRIPTION**

FIG. 1 is a front perspective view of an air sampling handheld biothreat detector with the sampler intake vent closed;

FIG. 2 is a perspective view of FIG. 1 with the sampler intake vent open;

FIG. 3 is a rear perspective view of the air sampling handheld biothreat detector shown in FIGS. 1 and 2;

FIG. 4 is a front elevational view of the air sampling handheld biothreat detector with the sampler intake vent open;

FIG. 5 is a rear elevational view of the air sampling handheld biothreat detector;

FIG. 6 is a right side elevational view of the air sampling handheld biothreat detector;

FIG. 7 is a left side elevational view of the air sampling handheld biothreat detector;

FIG. 8 is a top plan view of the air sampling handheld biothreat detector;

FIG. 9 is a bottom plan view of the air sampling handheld biothreat detector; and,

FIG. 10 is a perspective view showing the environment of an auxiliary docking station in phantom lines for extending the function and capability of the handheld detector.

The phantom lines are for illustrative purposes only, and form no part of the design.

**1 Claim, 10 Drawing Sheets**

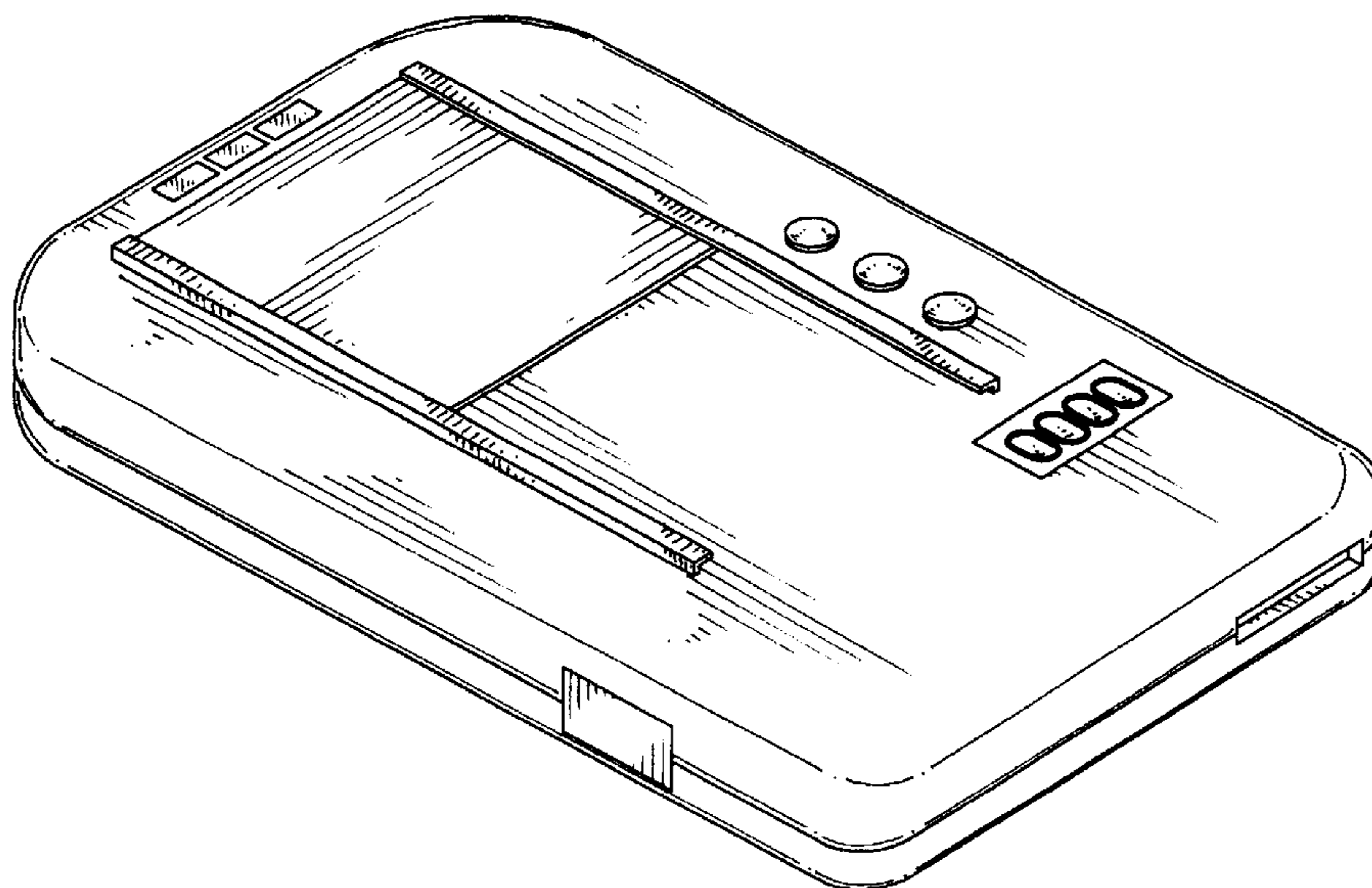

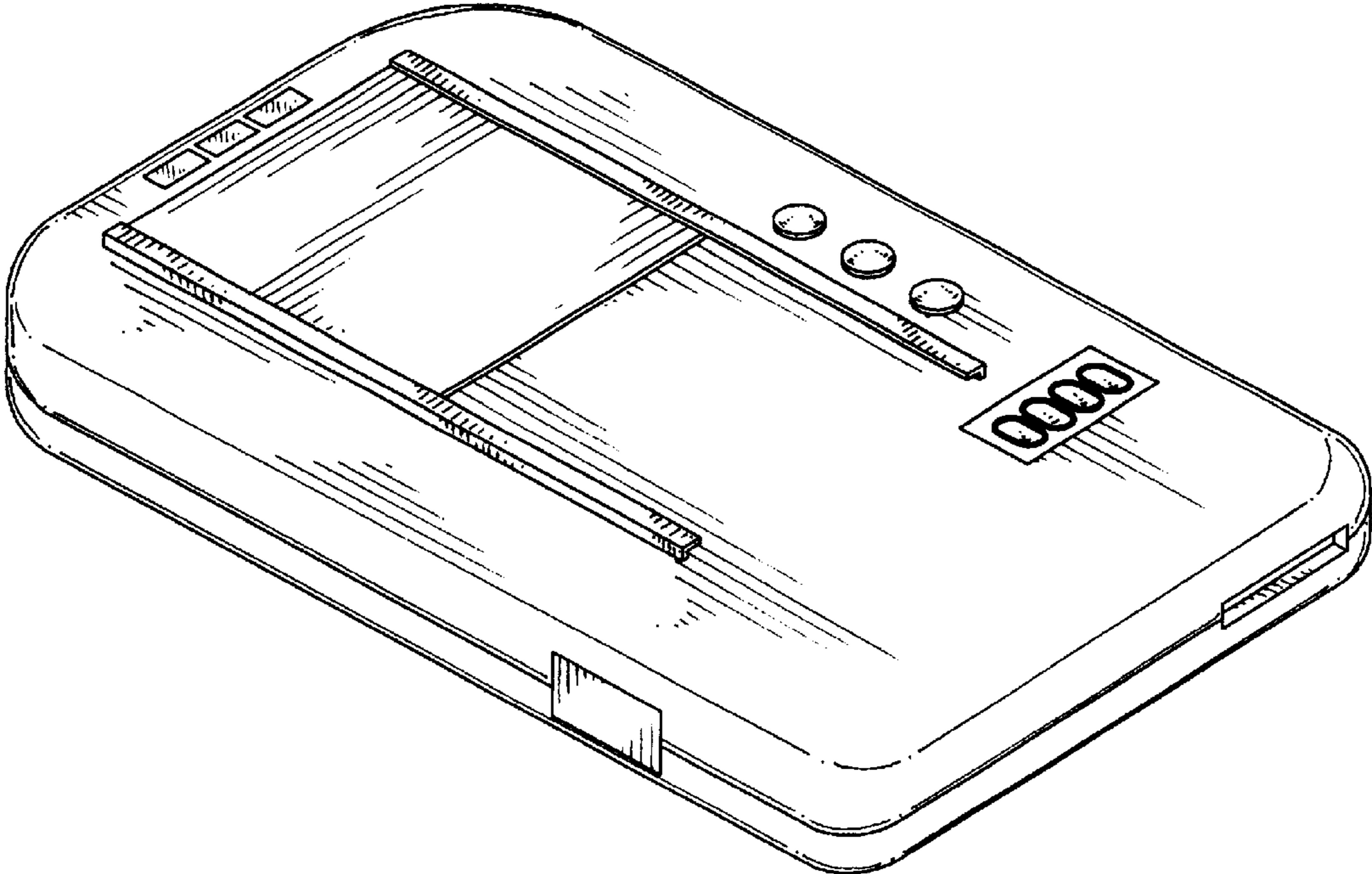

FIG. 1

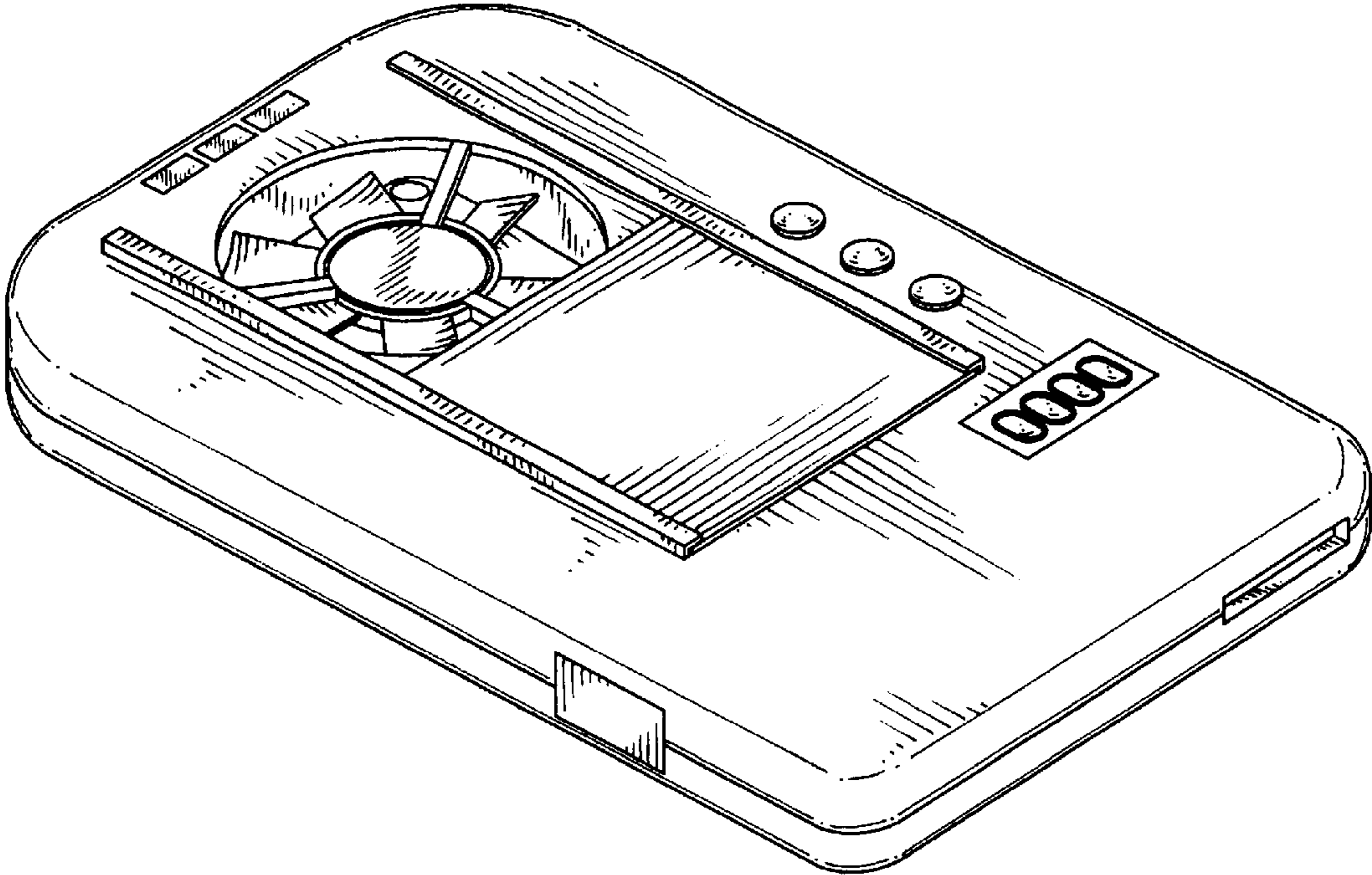

FIG. 2

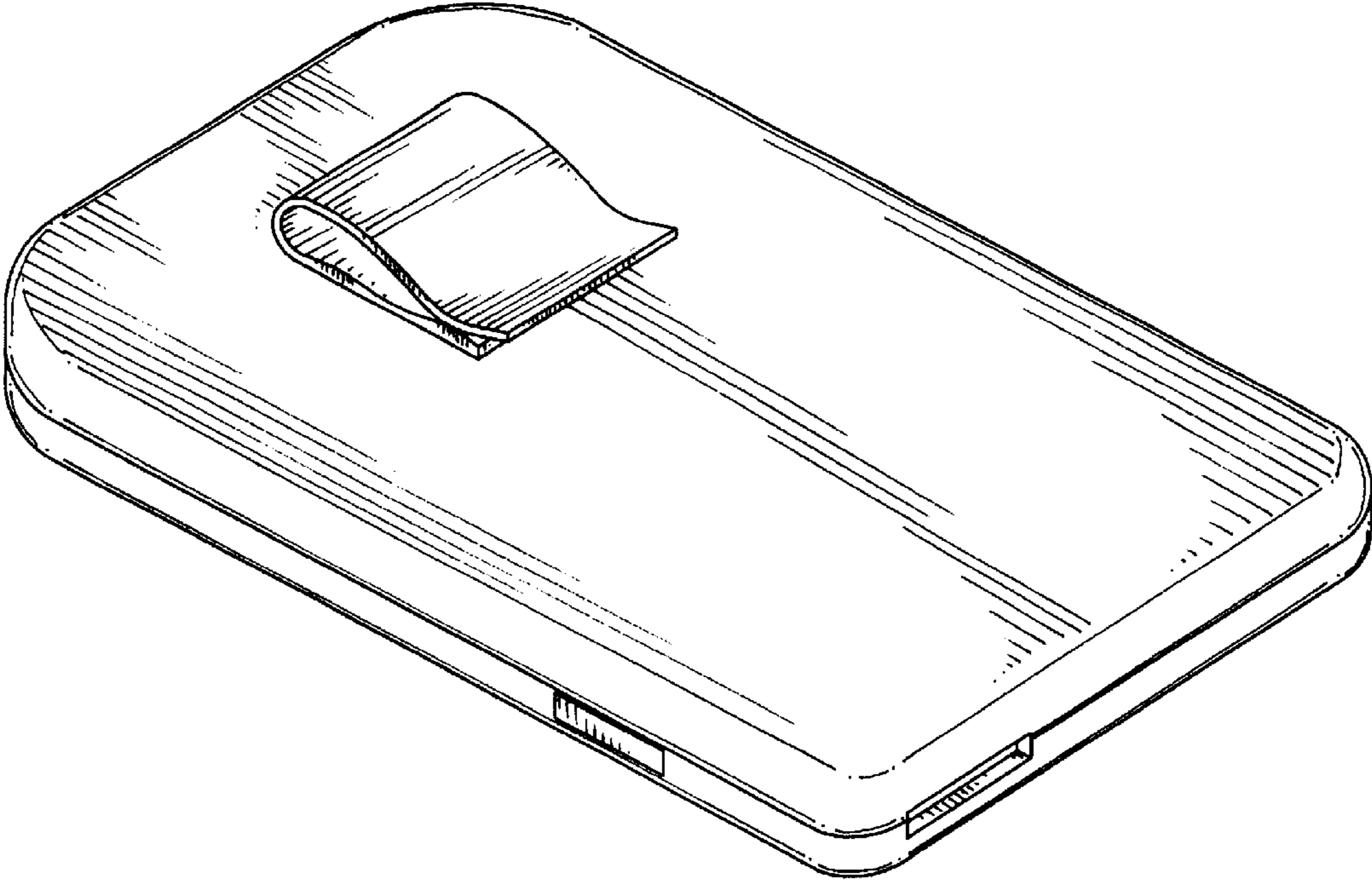

FIG. 3

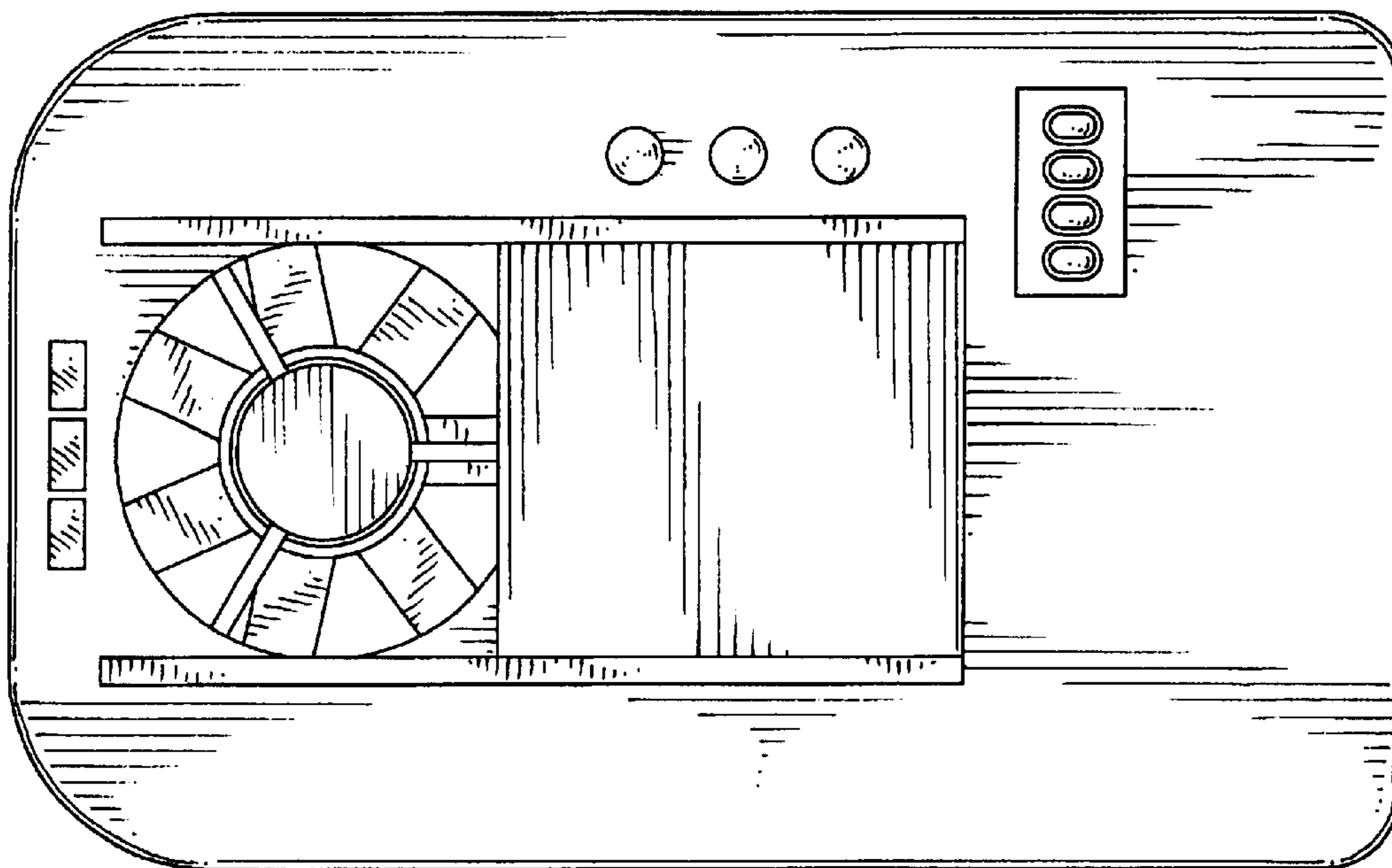

FIG. 4

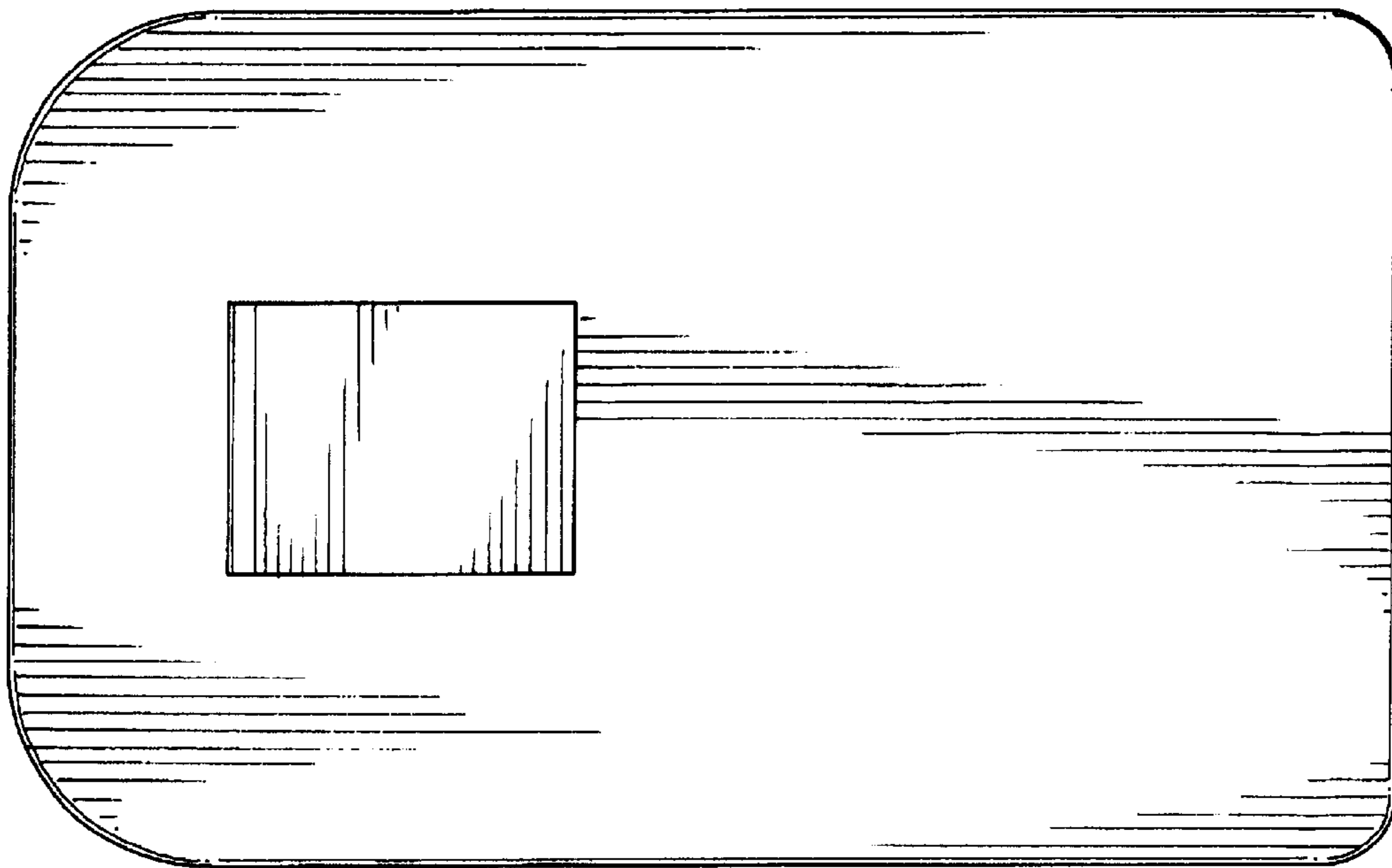

FIG. 5

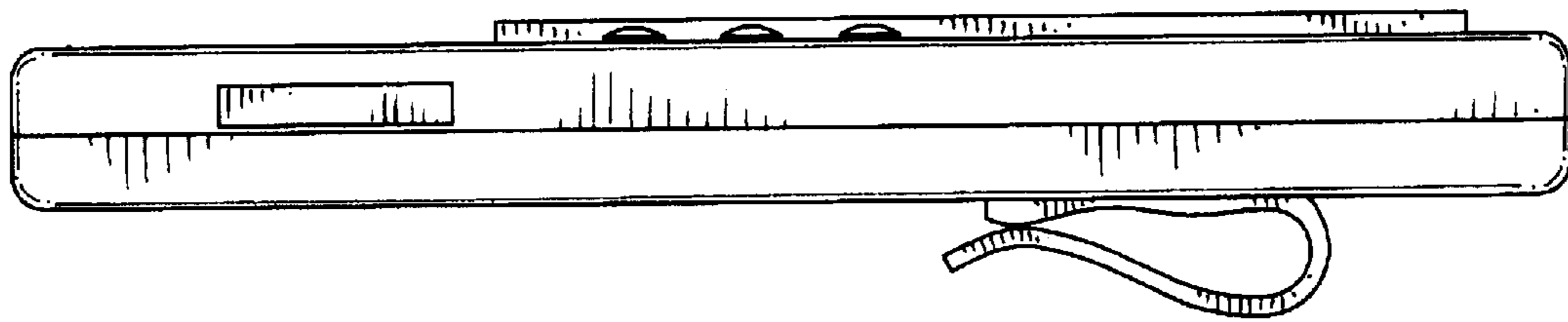

FIG. 6

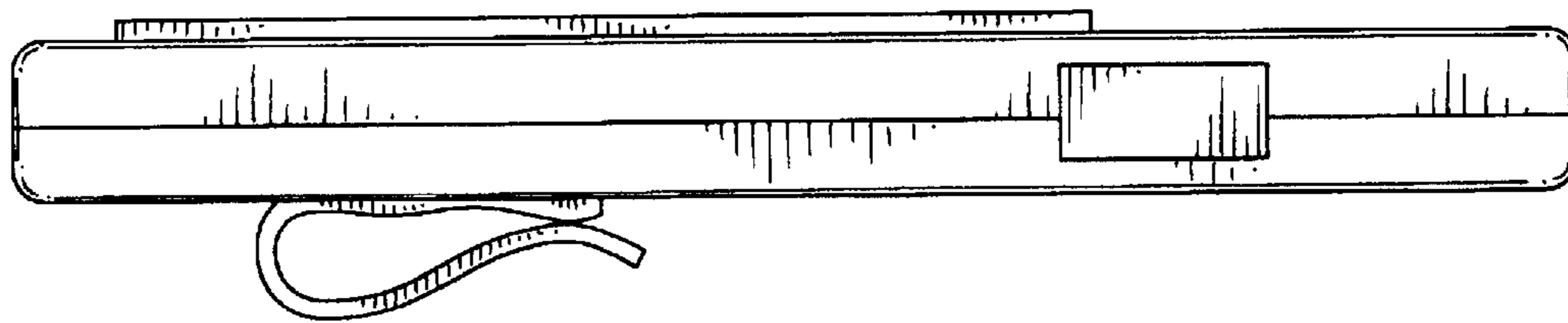

FIG. 7



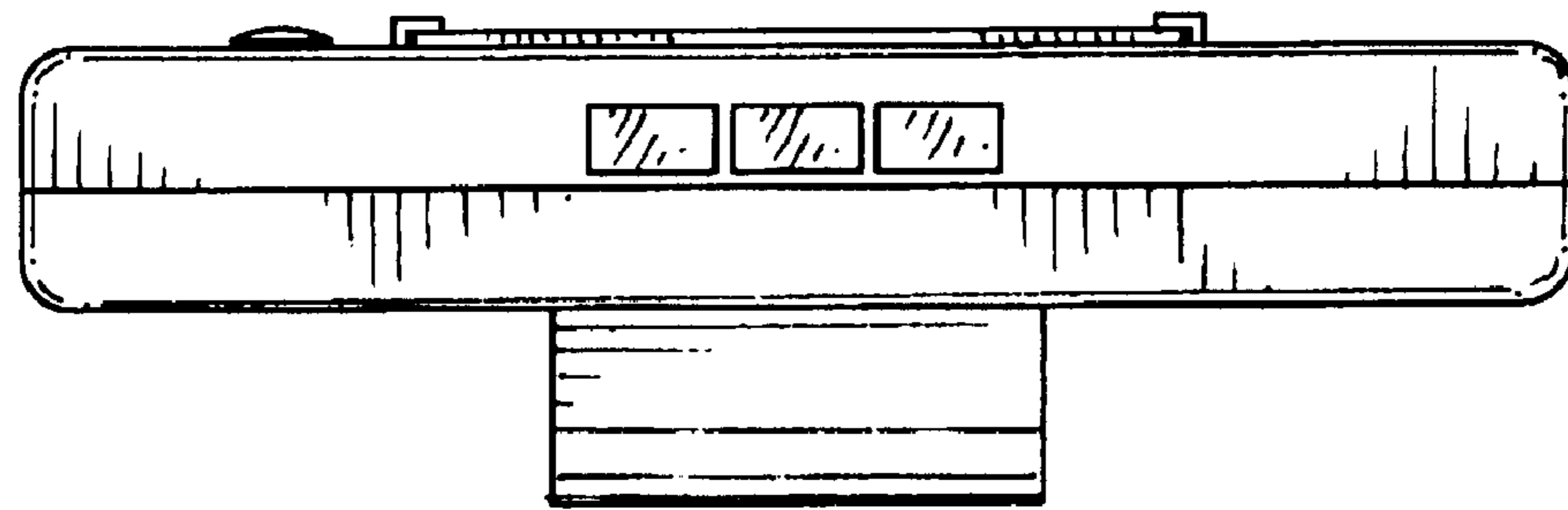

FIG. 8

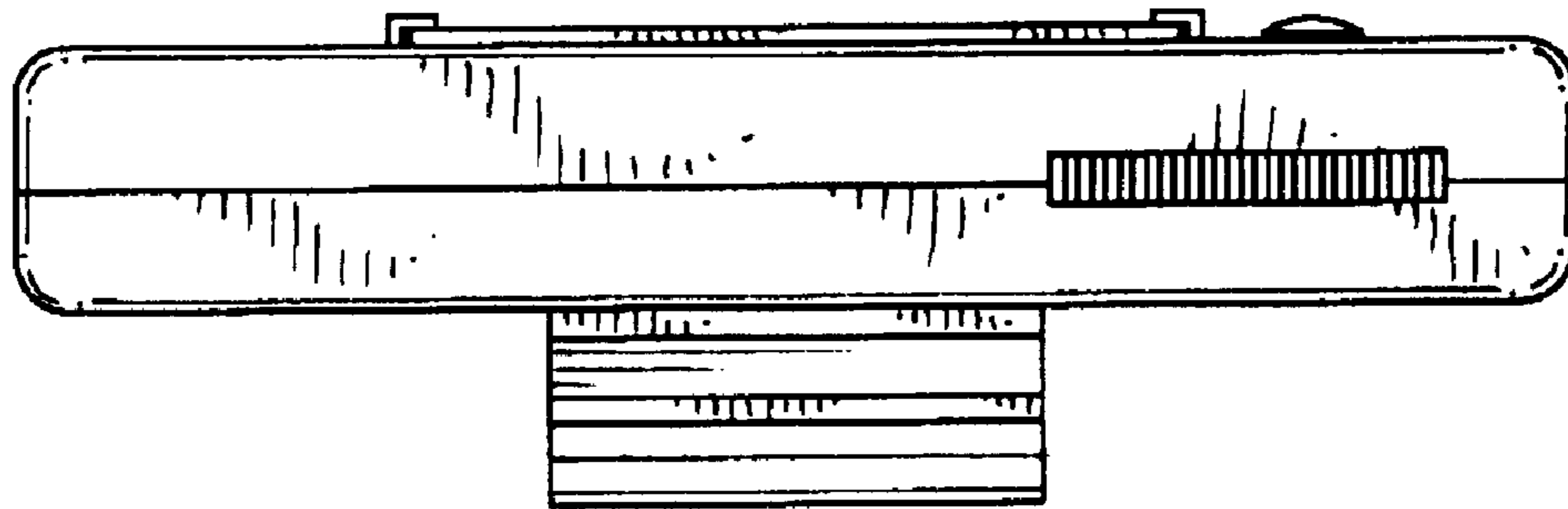

FIG. 9

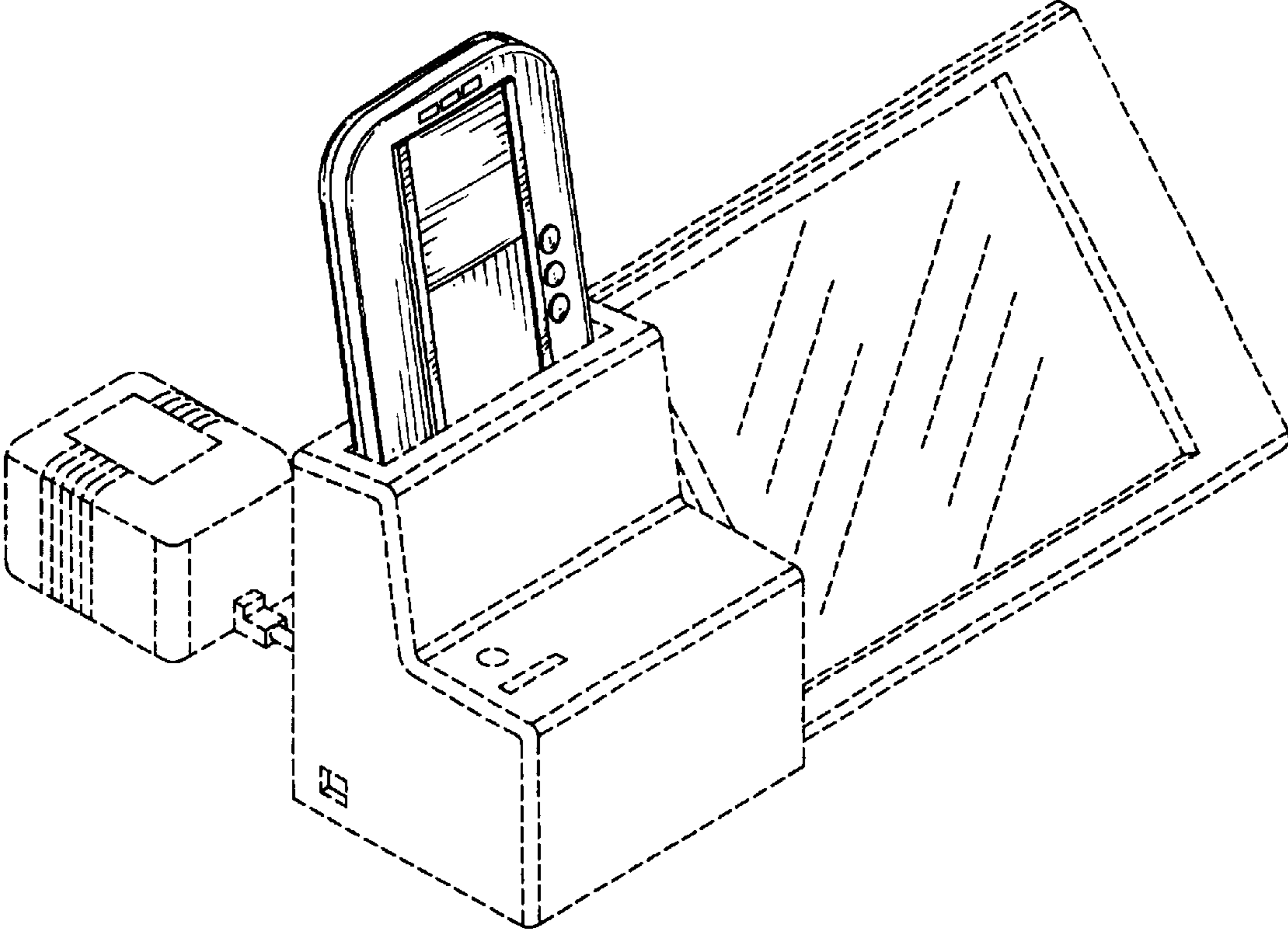

FIG. 10