

US00D500173S

(12) **United States Design Patent**
Wakayama

(10) **Patent No.:** **US D500,173 S**

(45) **Date of Patent:** **** Dec. 21, 2004**

(54) **HANDLE FOR A HOLDER FOR A SAFETY RAZOR BLADE**

(75) Inventor: **Yoshihiro Wakayama, Gifu (JP)**

(73) Assignee: **Kai R&D Center Co., Ltd., Gifu (JP)**

(**) Term: **14 Years**

(21) Appl. No.: **29/182,047**

(22) Filed: **May 20, 2003**

(30) **Foreign Application Priority Data**

Nov. 21, 2002 (JP) 2002-032132

(51) **LOC (7) Cl.** **28-03**

(52) **U.S. Cl.** **D28/48**

(58) **Field of Search** D28/44, 44.1,
D28/46-49; 30/32, 34.05, 34.1, 34.2, 41,
41.5, 41.6, 41.9, 47, 48, 526

(56) **References Cited**

U.S. PATENT DOCUMENTS

D268,291 S * 3/1983 Jones D28/48
D425,251 S * 5/2000 Gray D28/48
D476,113 S * 6/2003 Wonderley D28/48

D483,526 S * 12/2003 Efthimiadis et al. D28/48

* cited by examiner

Primary Examiner—Jennifer Rivard

(74) *Attorney, Agent, or Firm*—Sughrue Mion, PLLC

(57) **CLAIM**

The ornamental design for a handle for a holder for a safety razor blade, as shown and described.

DESCRIPTION

FIG. 1 is a bottom plan view of a handle for a holder for a safety razor blade showing my new design, the holder being shown in broken lines;

FIG. 2 is a top plan view thereof;

FIG. 3 is a right side elevational view thereof, the left side being a mirror image thereof;

FIG. 4 is a front elevational view thereof;

FIG. 5 is a rear elevational view thereof;

FIG. 6 is a sectional view taken along the line 6—6 of FIG. 1; and,

FIG. 7 is a sectional view taken along the line 7—7 of FIG. 2.

The elements shown in broken lines are for illustrative purposes only and form no part of the claimed design.

1 Claim, 3 Drawing Sheets

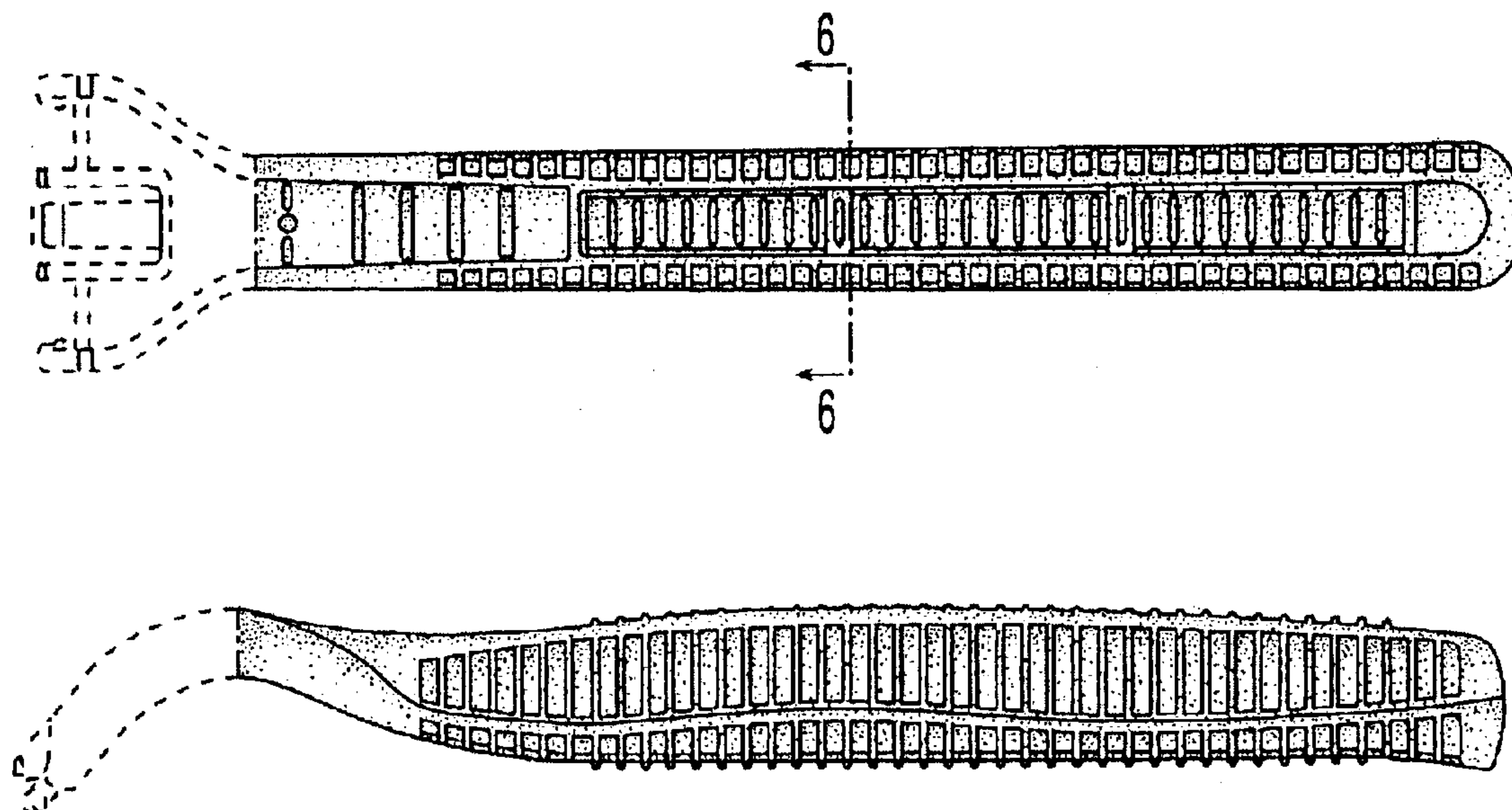

FIG. 1

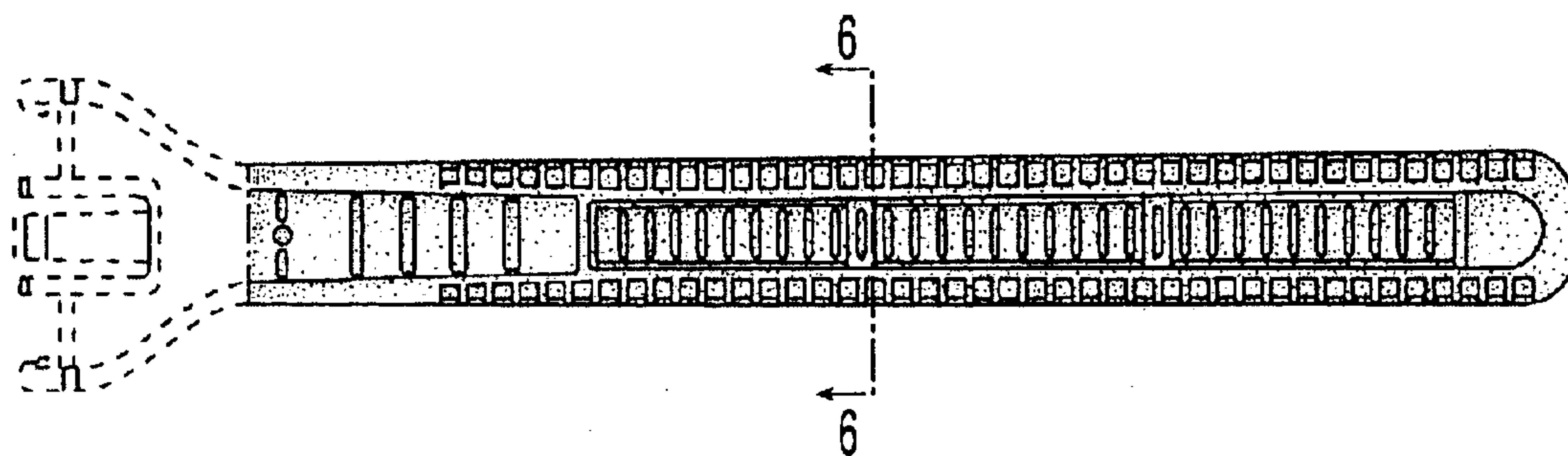

FIG. 2

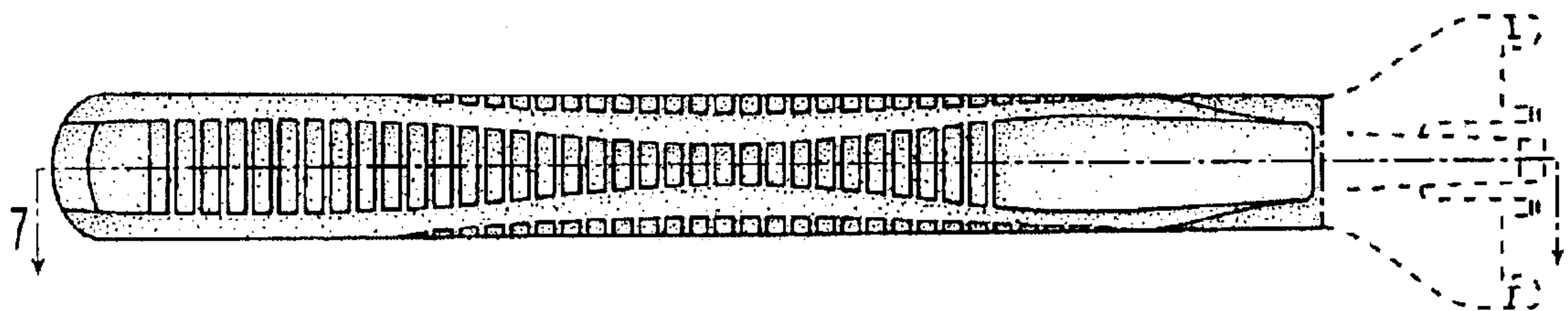

FIG. 3

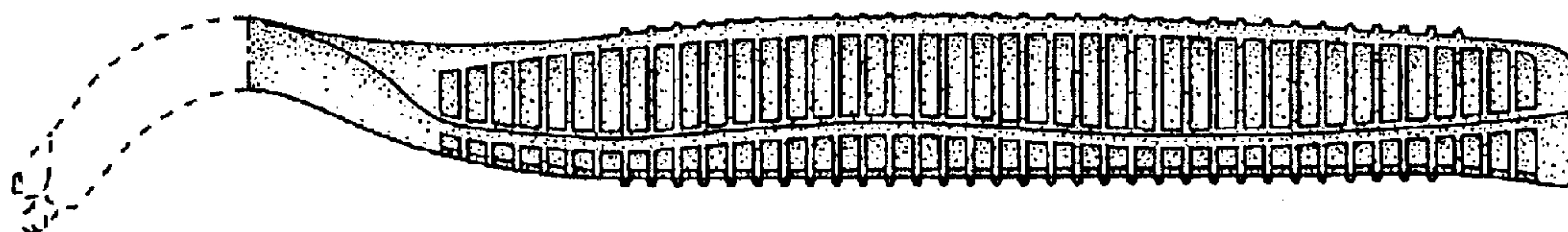

FIG. 4

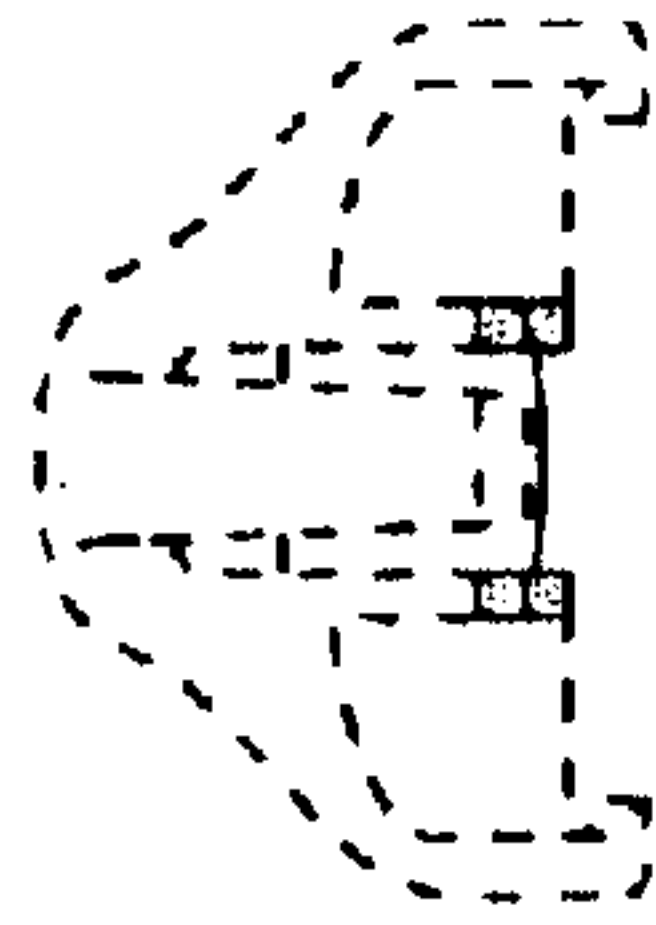

FIG. 5

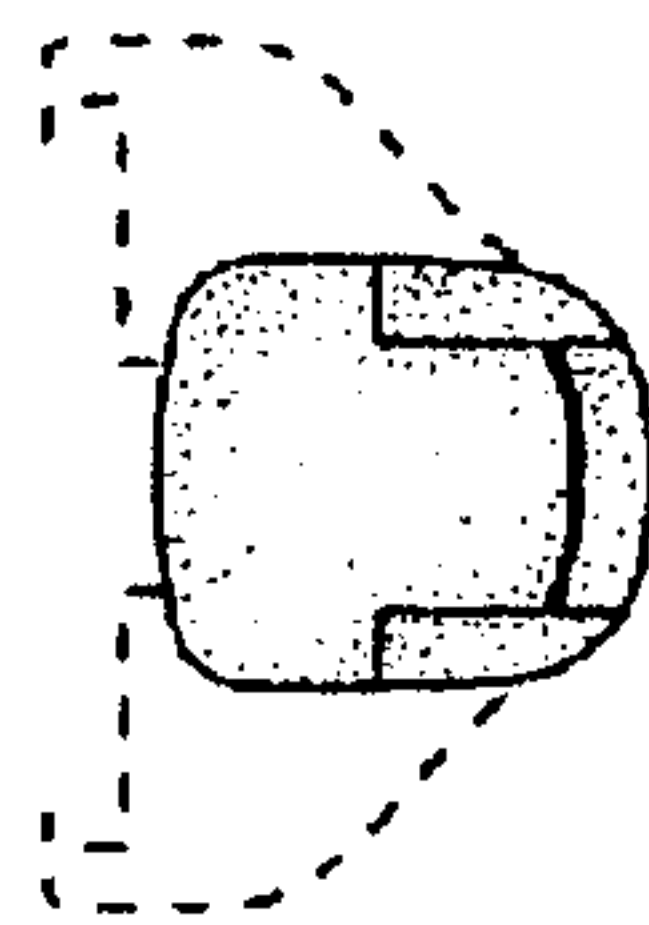

FIG. 6

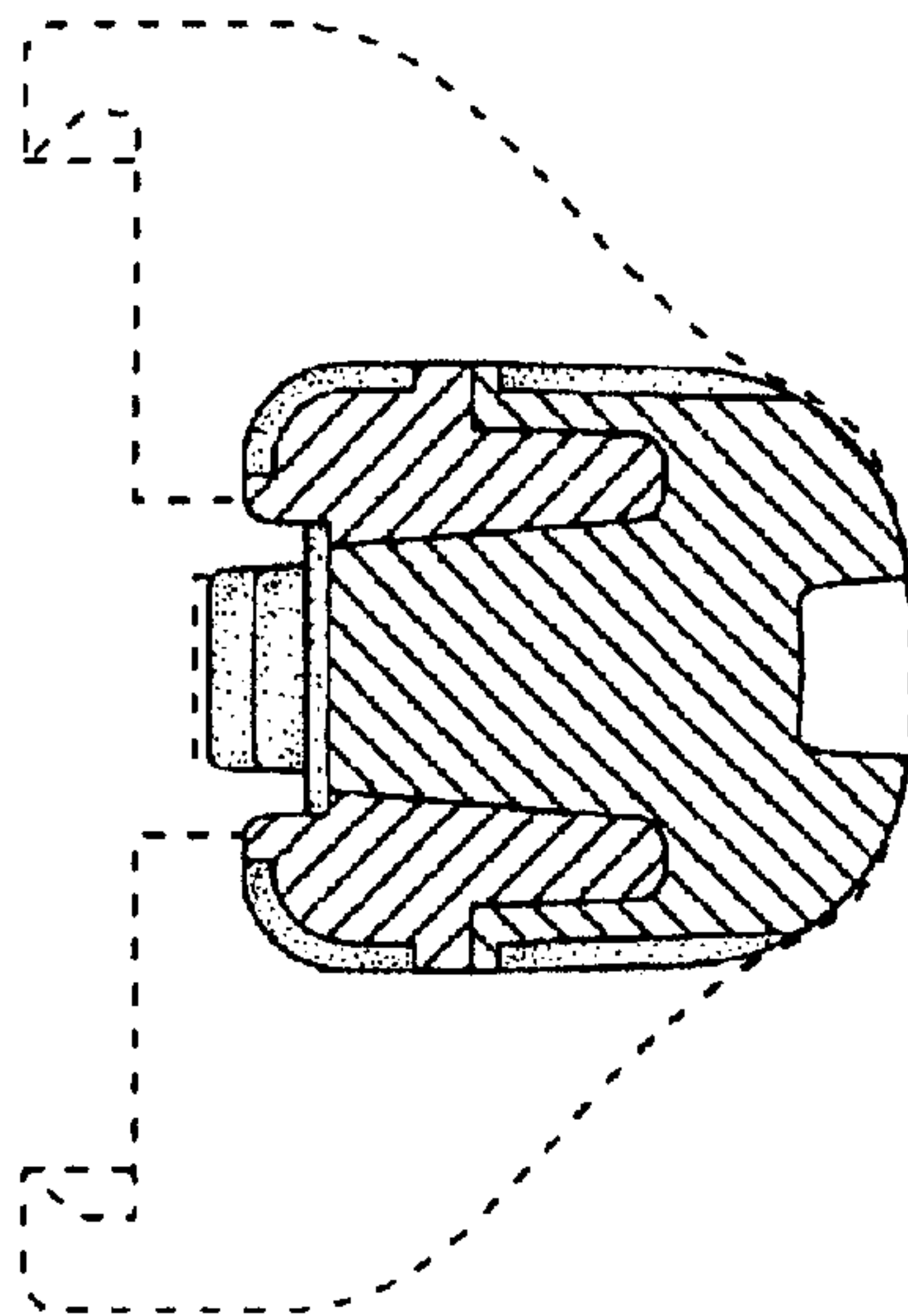

FIG. 7

