

US00D500169S

(12) **United States Design Patent**
Dombrowski et al.

(10) **Patent No.: US D500,169 S**

(45) **Date of Patent: ** Dec. 21, 2004**

(54) **SHAVER HANDLE**

(75) Inventors: **David Dombrowski**, Madison, CT (US); **Christine Ciccone**, New Haven, CT (US); **Sean Lukan**, Milford, CT (US)

(73) Assignee: **Eveready Battery Company, Inc.**, St. Louis, MO (US)

(**) Term: **14 Years**

(21) Appl. No.: **29/178,834**

(22) Filed: **Apr. 1, 2003**

(51) **LOC (7) Cl.** **28-03**

(52) **U.S. Cl.** **D28/46**

(58) **Field of Search** D28/44, 44.1, D28/45-49, 51-53; 30/32, 34.05, 34.1, 34.2, 41, 41.9, 43-43.9, 43.91, 43.92, 44, 45, 47-51, 57, 526

(56) **References Cited**

U.S. PATENT DOCUMENTS

D326,166 S * 5/1992 Yanagida et al. D28/49

D392,412 S * 3/1998 Kip D28/49
6,161,287 A * 12/2000 Swanson et al. 30/50
D479,361 S * 9/2003 Micinilio D28/49
D482,821 S * 11/2003 Seifert D28/44.1

* cited by examiner

Primary Examiner—Jennifer Rivard

(74) *Attorney, Agent, or Firm*—McCormick, Paulding & Huber LLP

(57) **CLAIM**

The ornamental design for a shaver handle, as shown and described.

DESCRIPTION

FIG. 1 is a front view showing of our new design; FIG. 2 is a right side view thereof; FIG. 3 is a rear side view thereof; FIG. 4 is a left side view thereof; FIG. 5 is a top view thereof; and, FIG. 6 is a bottom view thereof.

The portions shown in broken lines on the drawings represent environment only, and form no part of the claimed design.

1 Claim, 6 Drawing Sheets

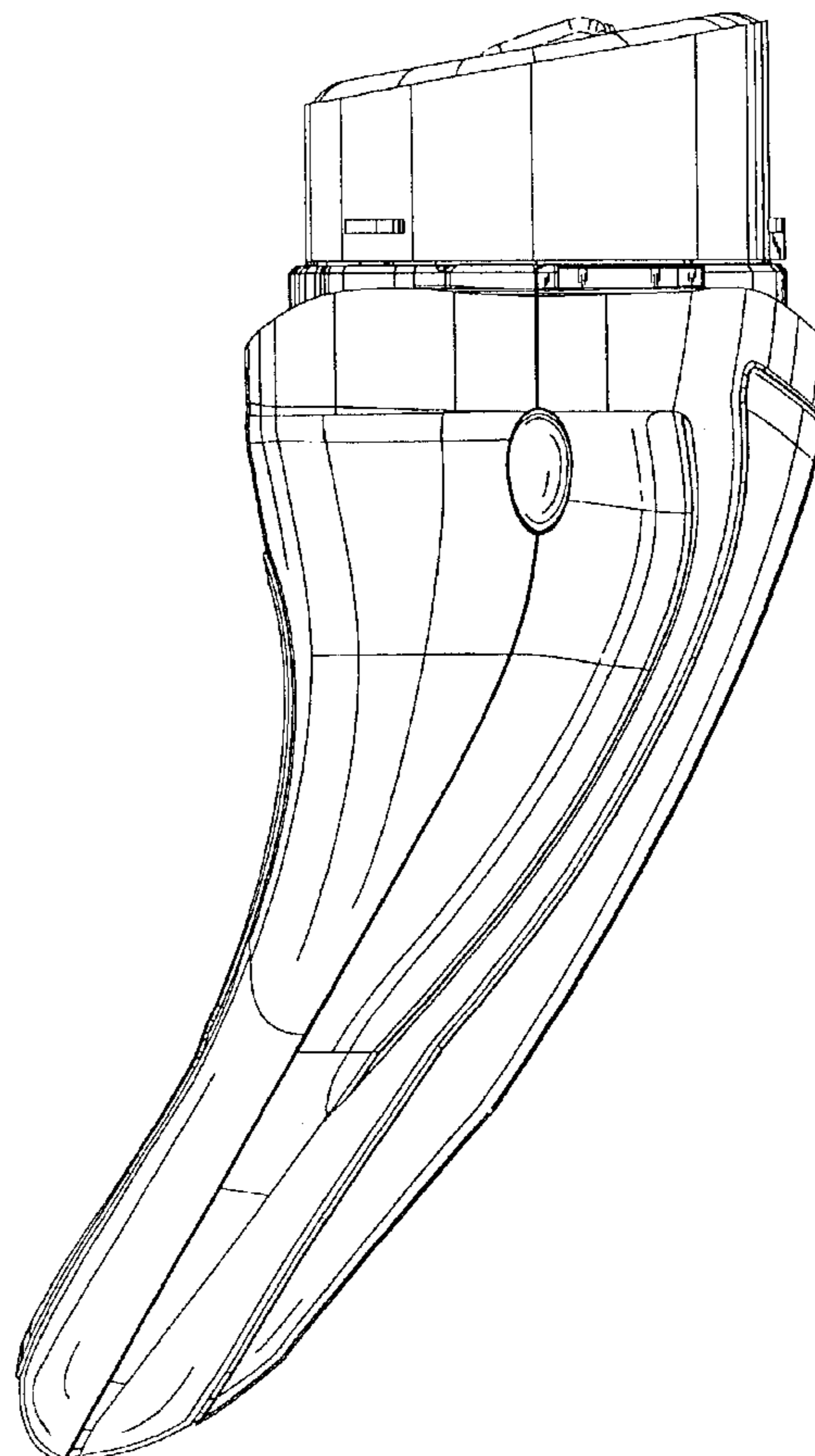
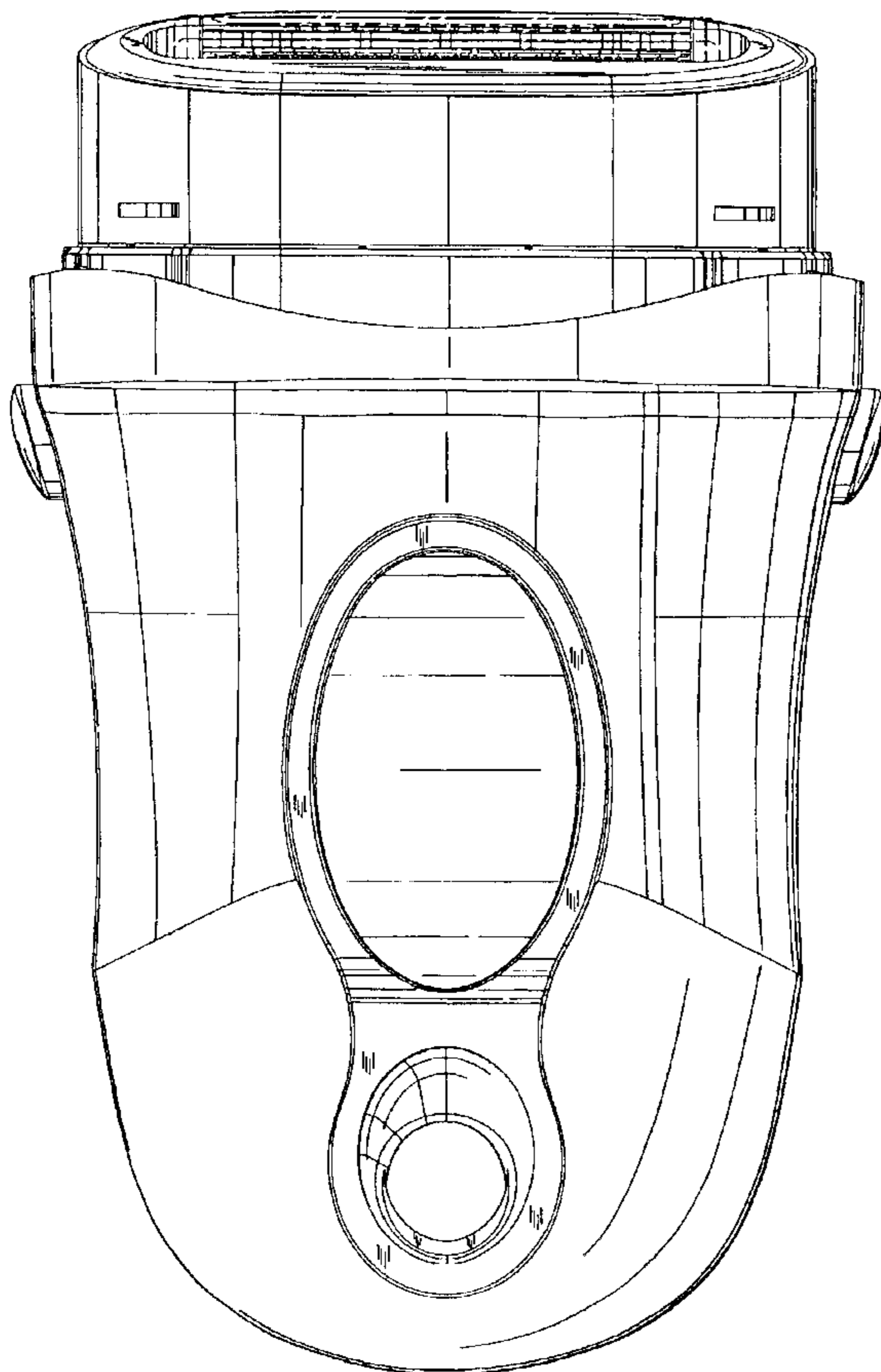

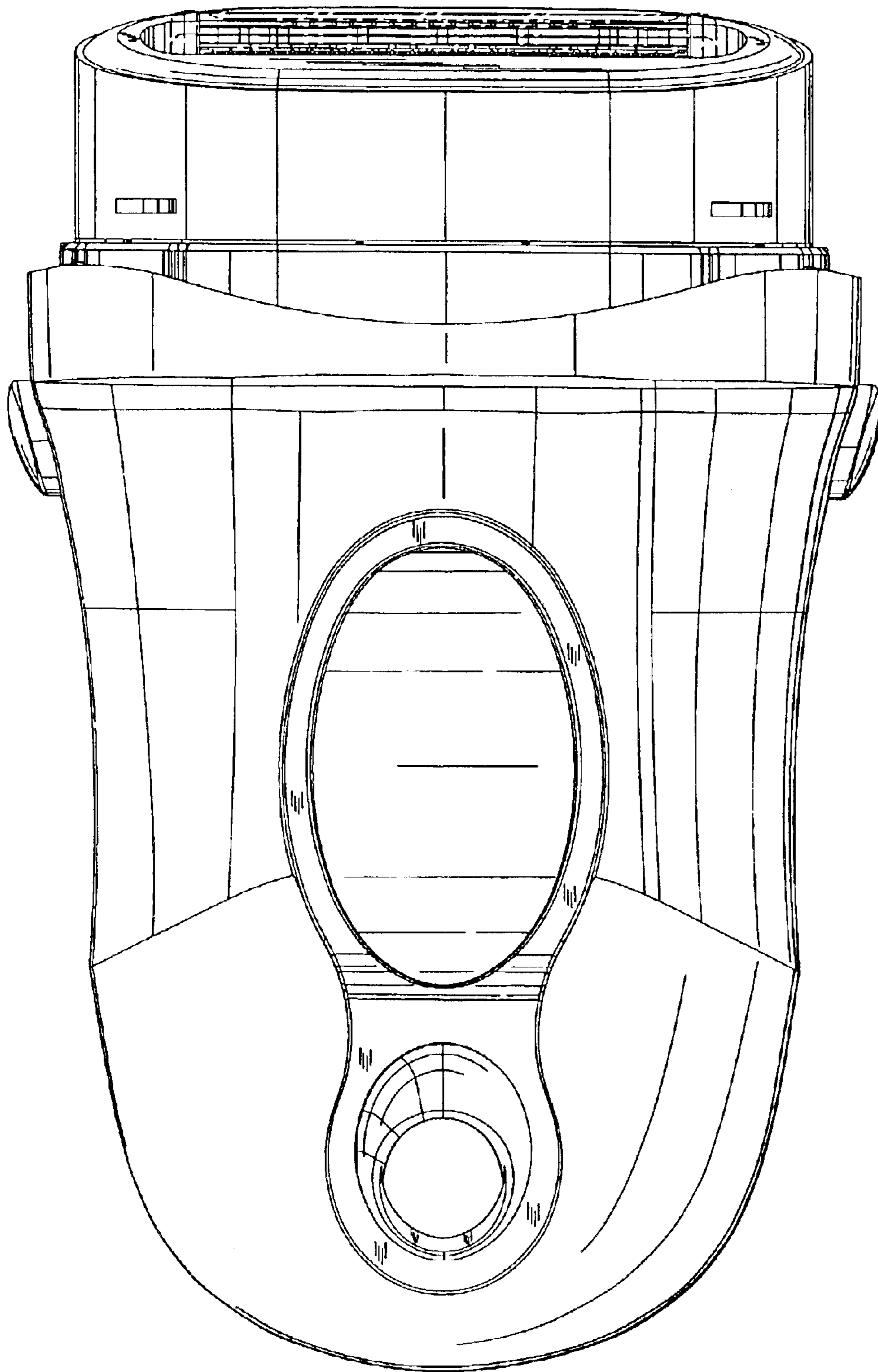

FIG. 1

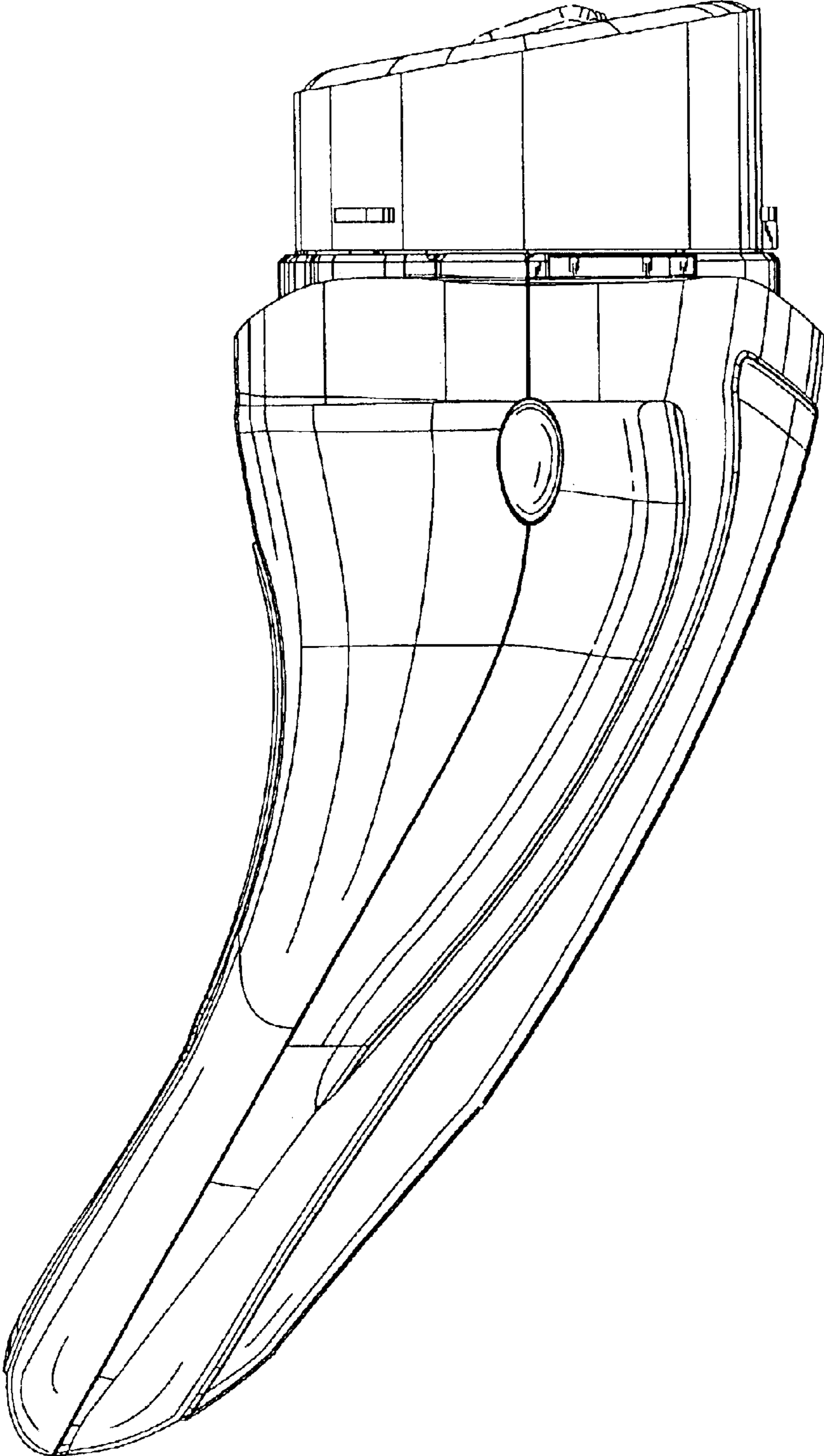

FIG. 2

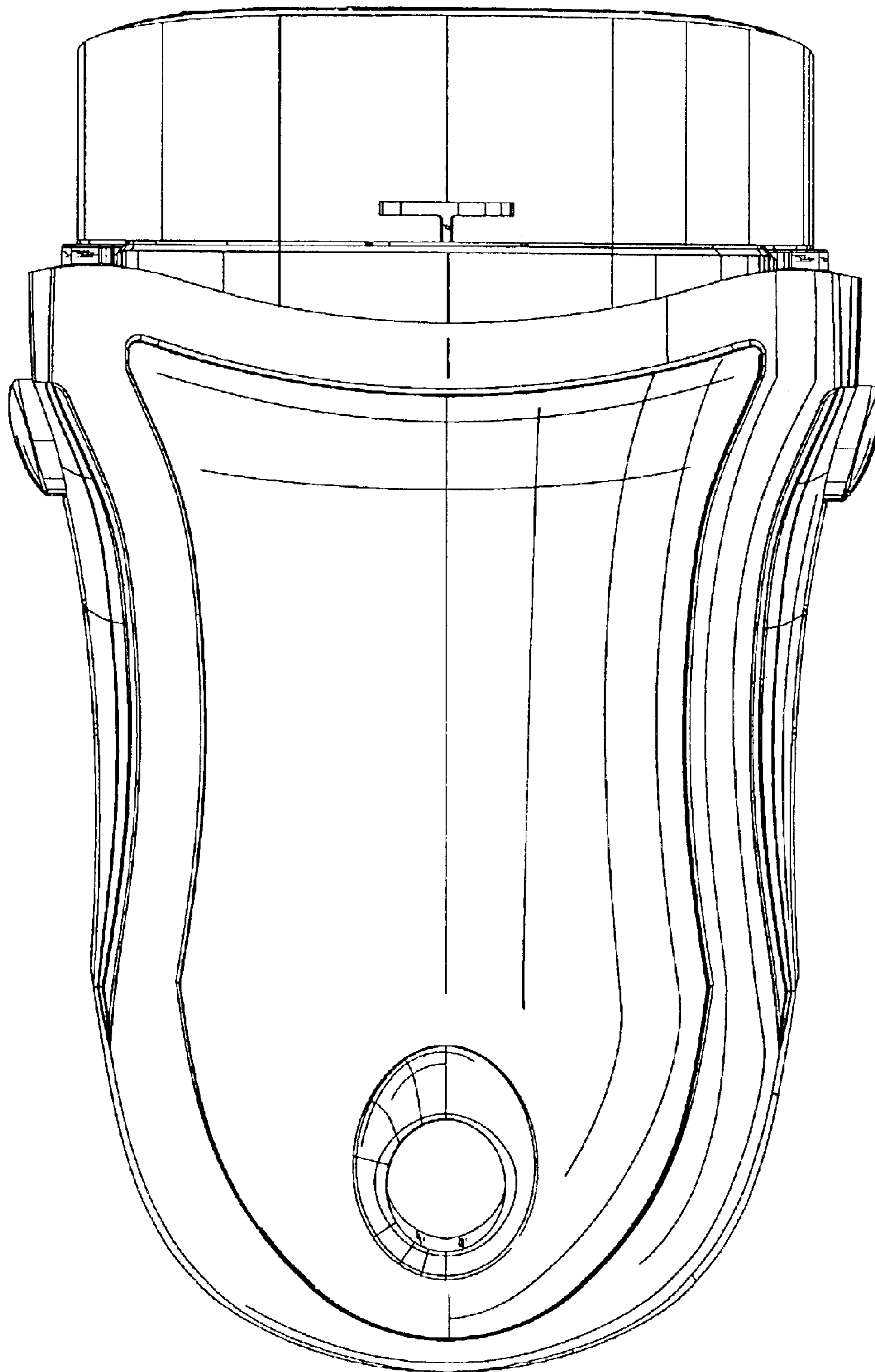

FIG. 3

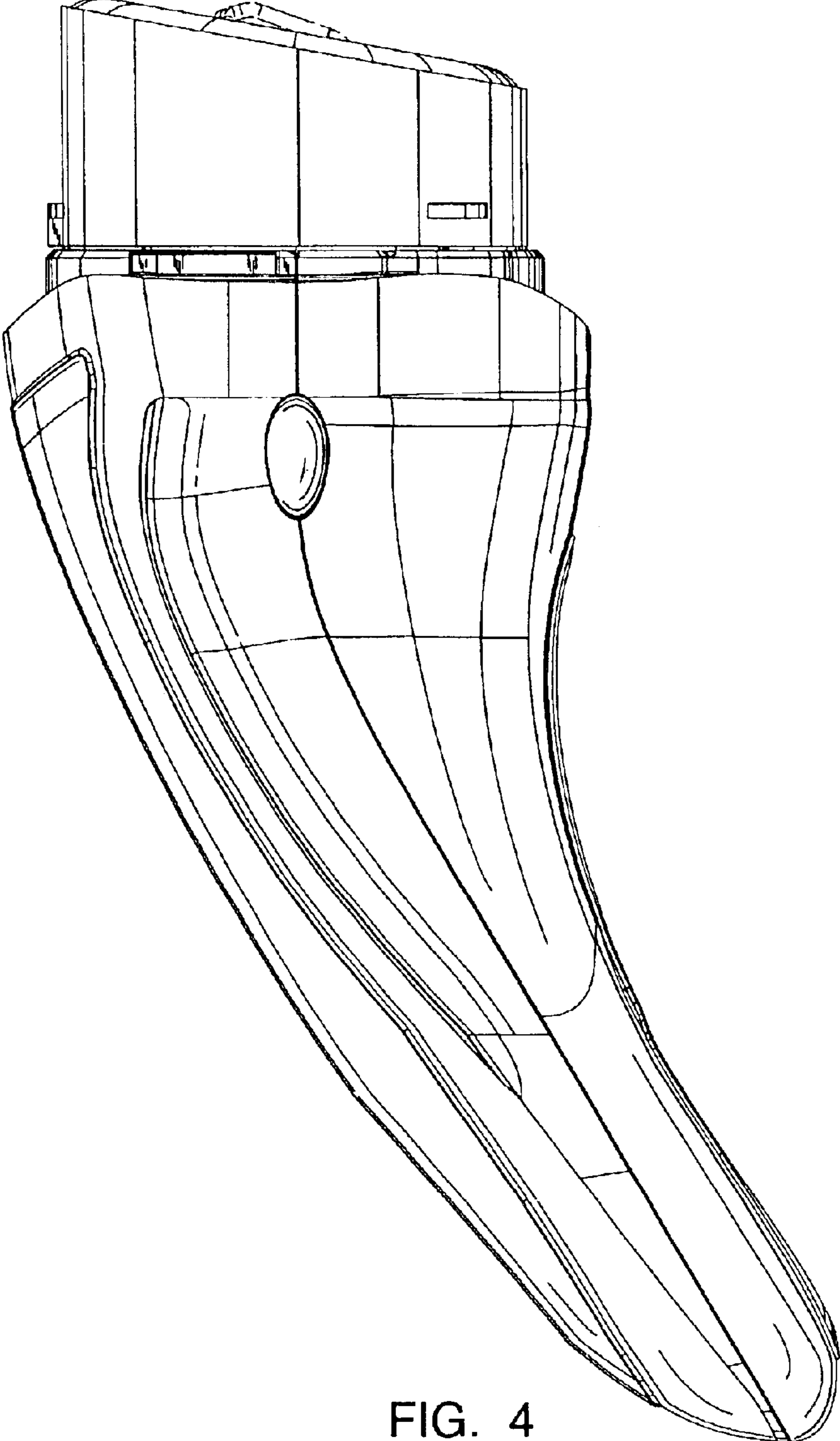

FIG. 4

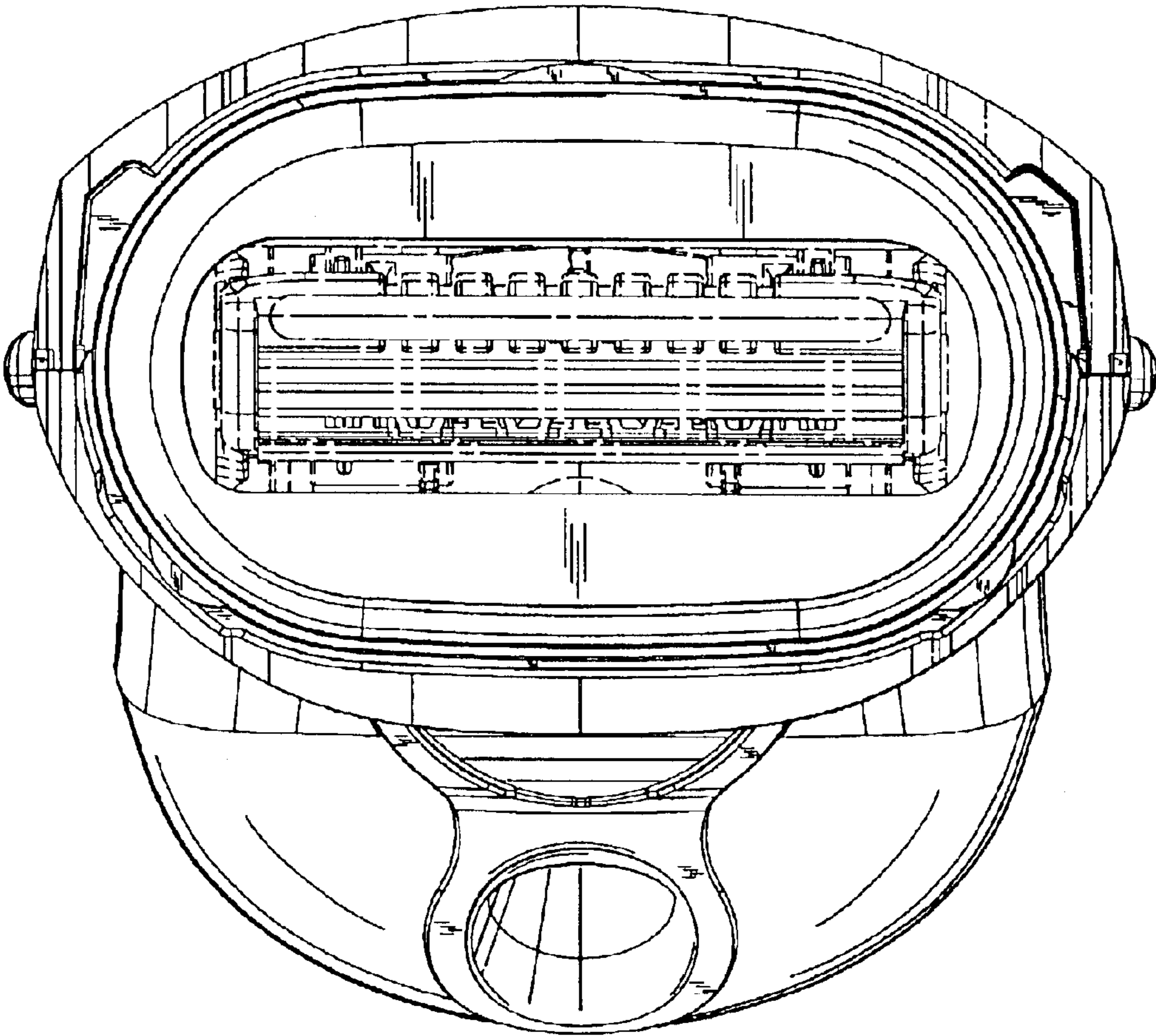

FIG. 5

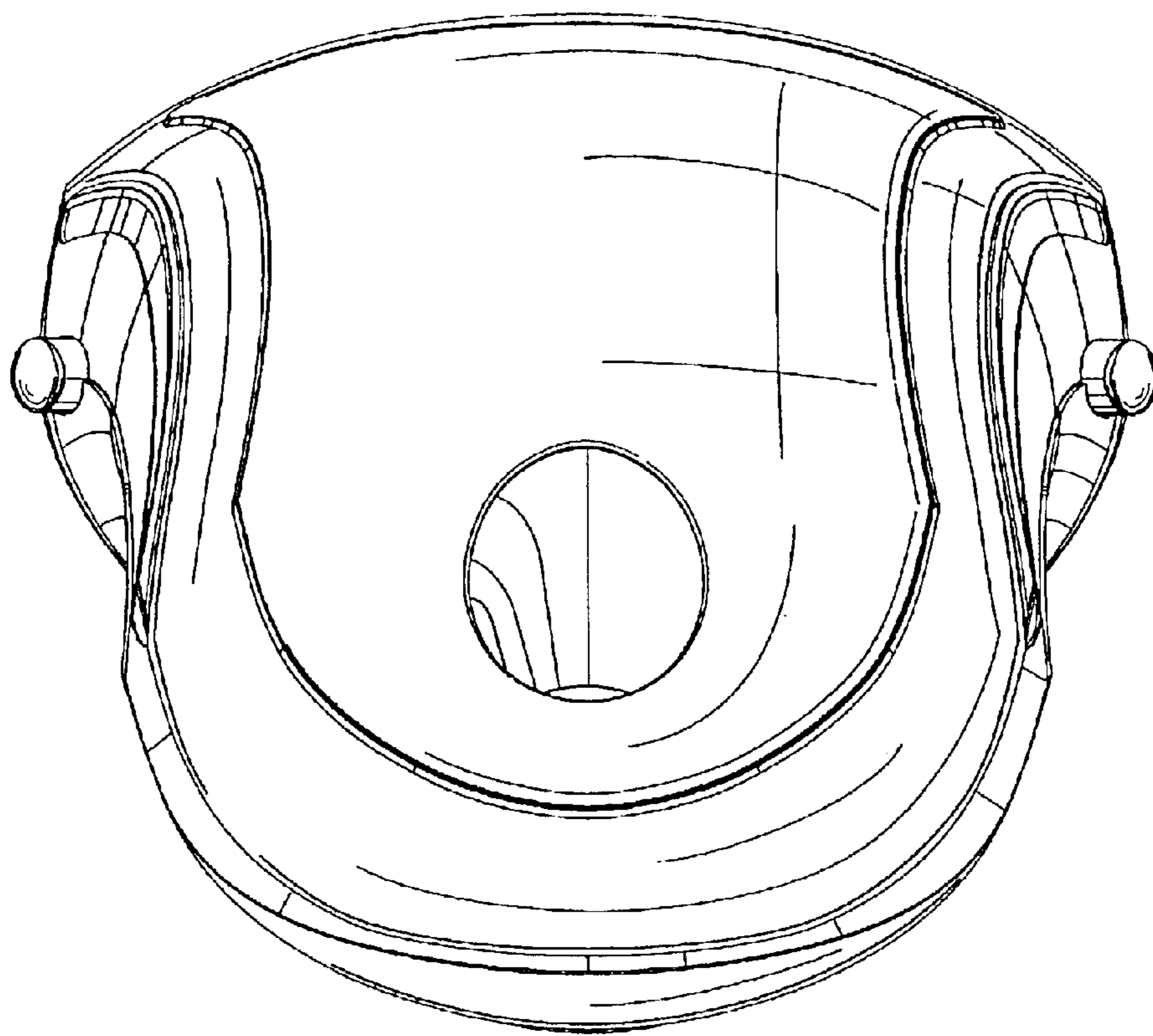

FIG. 6