

US00D500166S

(12) **United States Design Patent**
Naden

(10) **Patent No.:** **US D500,166 S**
(45) **Date of Patent:** **** Dec. 21, 2004**

- (54) **NO SMOKING SIGN ASHTRAY**
- (75) Inventor: **Mark Cameron Naden**, New York, NY (US)
- (73) Assignee: **Toda, LLC**, New York, NY (US)
- (**) Term: **14 Years**
- (21) Appl. No.: **29/171,709**
- (22) Filed: **Nov. 27, 2002**
- (51) **LOC (7) Cl.** **27-05**
- (52) **U.S. Cl.** **D27/131**
- (58) **Field of Search** 131/231, 235.1, 131/236, 240.1, 241, 242; D27/102, 103, 106, 108, 125, 131, 133, 134, 135

(56) **References Cited**

U.S. PATENT DOCUMENTS

- D286,918 S * 11/1986 Valencia D27/106
- 4,926,573 A * 5/1990 Hetrick 131/270
- D402,399 S * 12/1998 Fowler D27/135
- D430,952 S * 9/2000 Haywood D27/131

D453,236 S * 1/2002 Hsu D27/134

* cited by examiner

Primary Examiner—Jennifer Rivard

(74) *Attorney, Agent, or Firm*—Mayer Fortkort & Williams, PC; Michael P. Fortkort, Esq.

(57) **CLAIM**

The ornamental design for a no smoking sign ashtray, as shown and described.

DESCRIPTION

FIG. 1 is a top view of a preferred embodiment of a no smoking sign ashtray;
 FIG. 2 is a section view thereof;
 FIG. 3 is a side view thereof;
 FIG. 4 is a section view thereof;
 FIG. 5 is a side view thereof;
 FIG. 6 is a section view thereof; and,
 FIG. 7 is a perspective view thereof.

The broken lines in the figures are for illustrative purposes only and form no part of the claimed design.

1 Claim, 3 Drawing Sheets

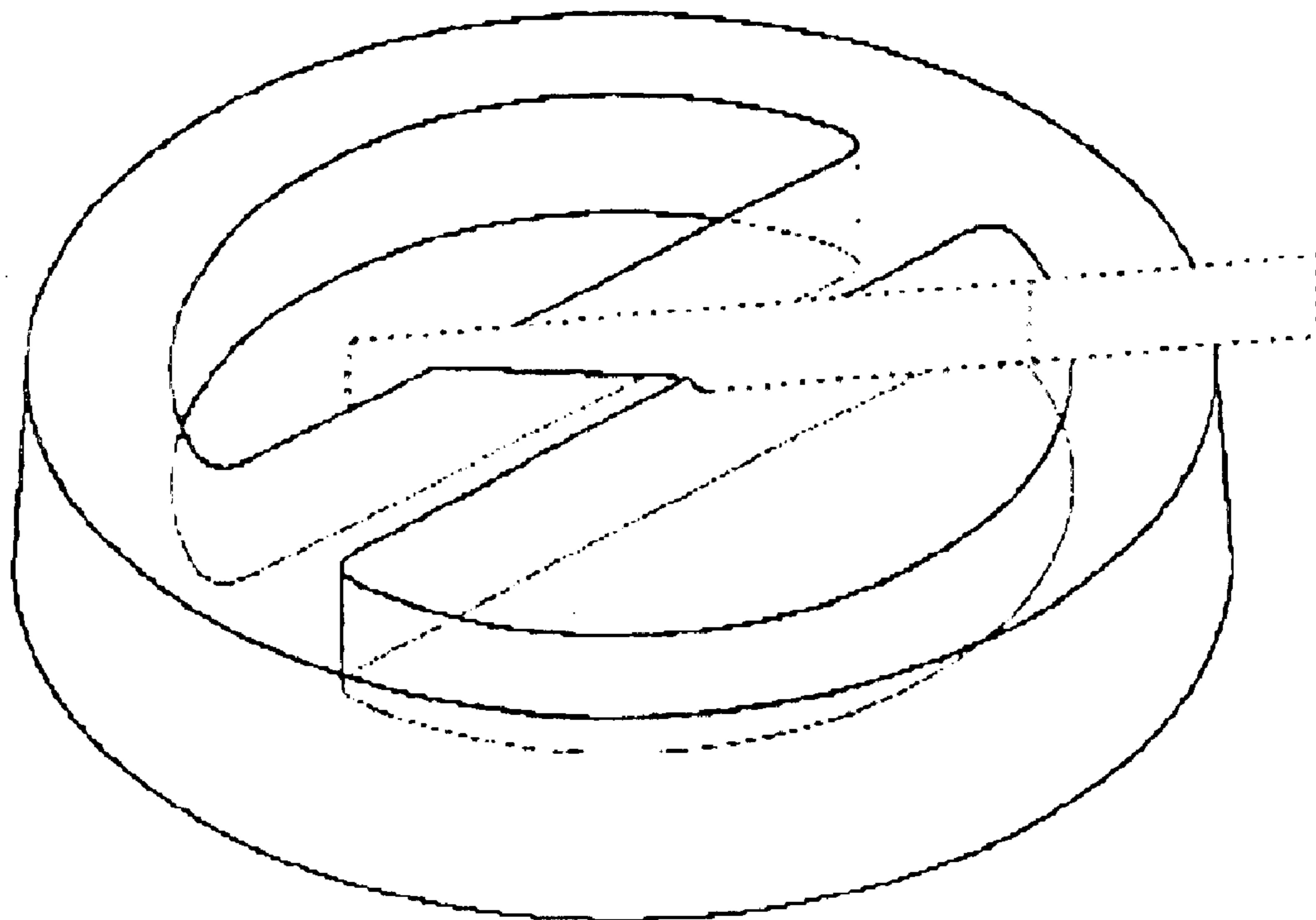

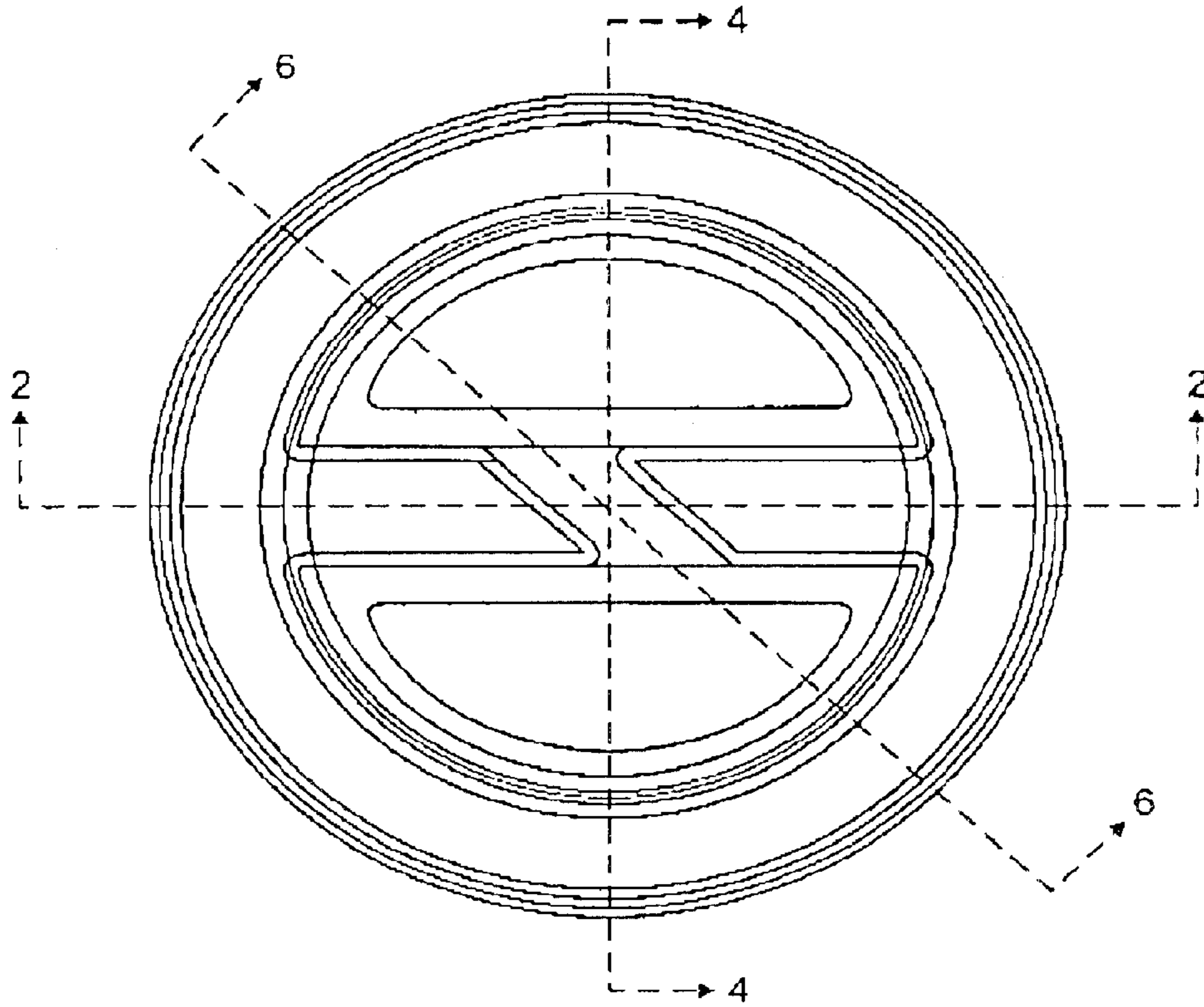

FIG. 1

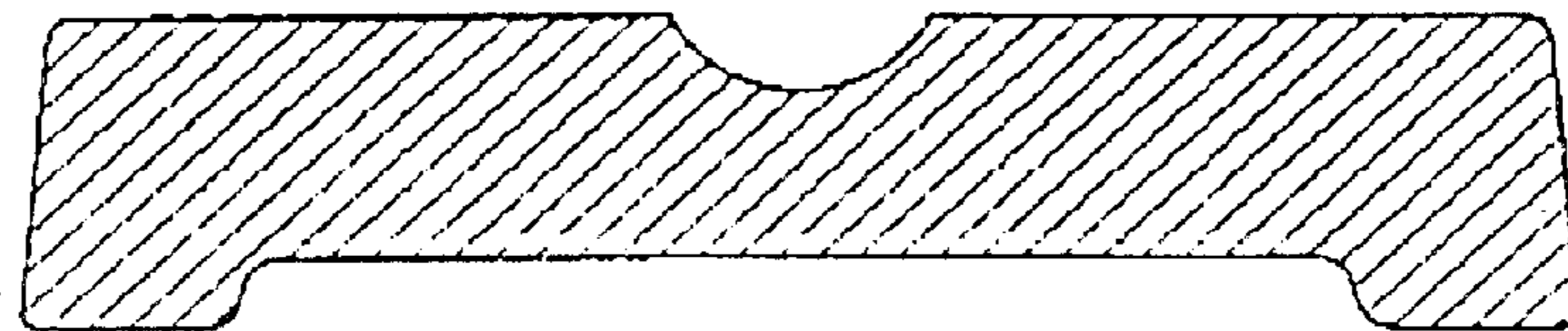

FIG. 2

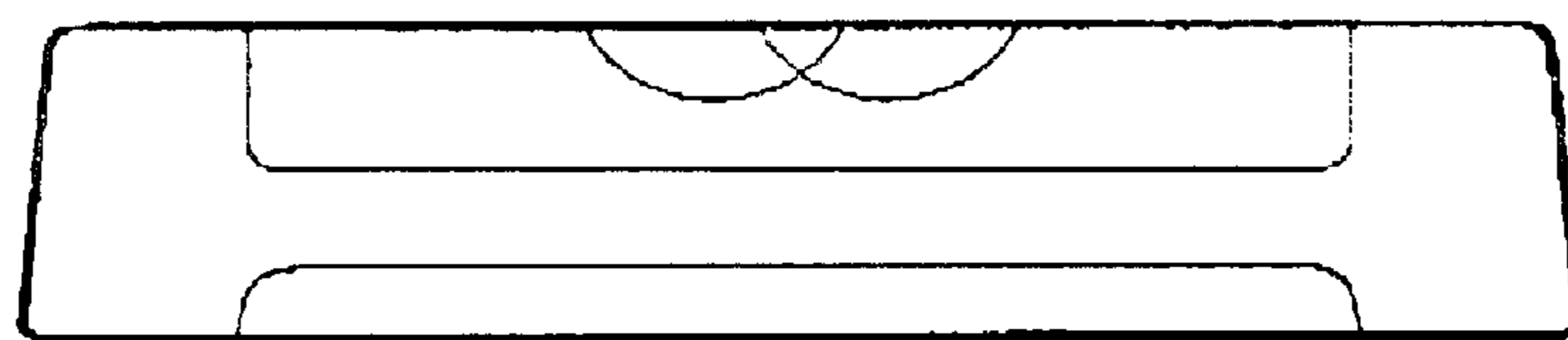

FIG. 3

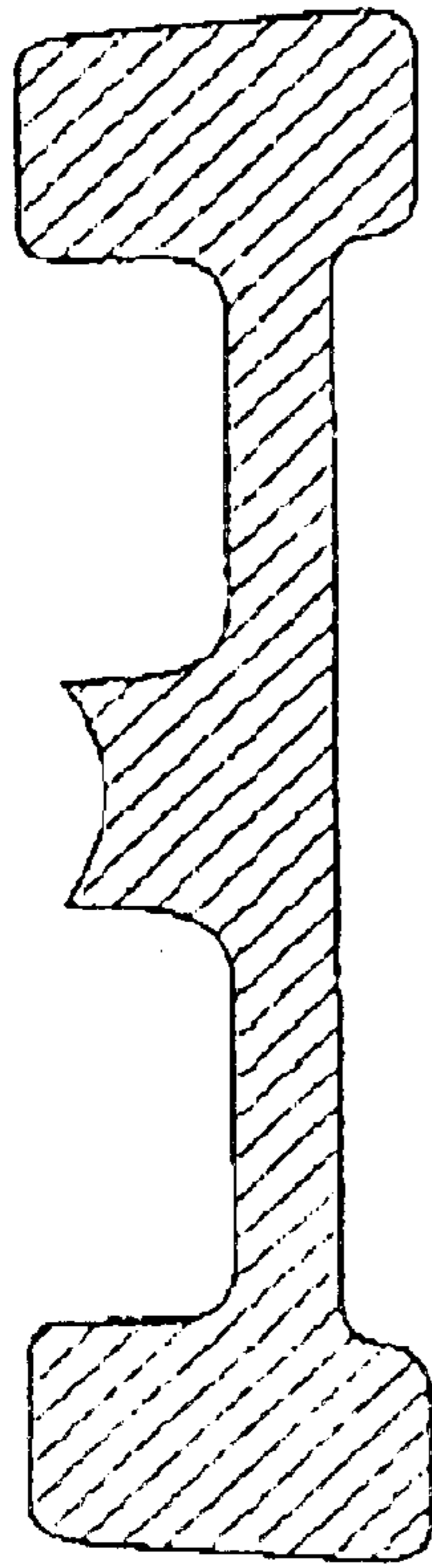

FIG. 4

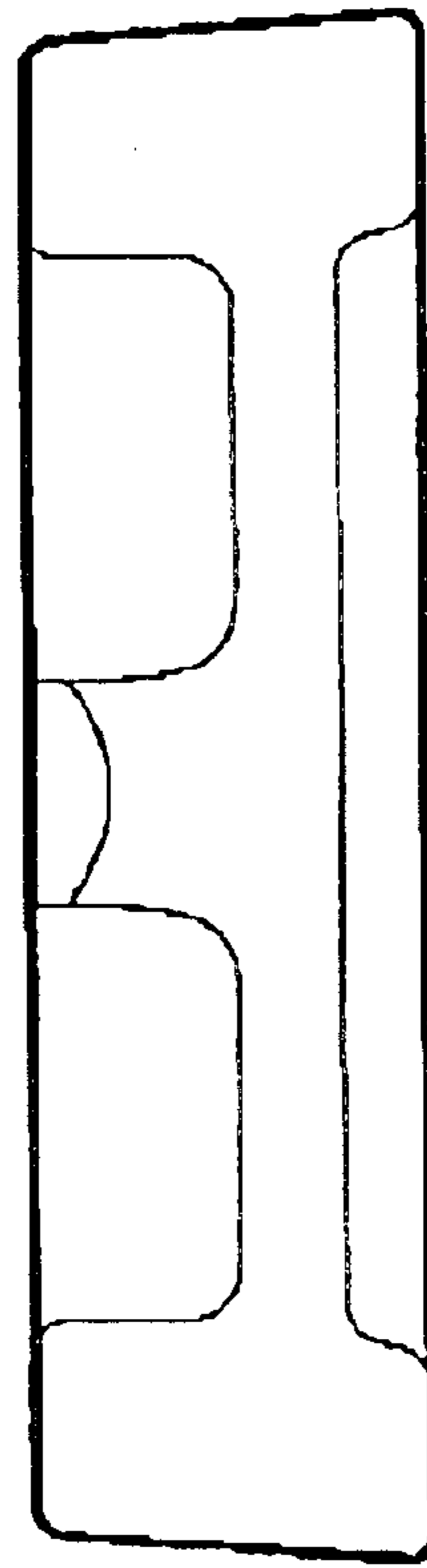

FIG. 5

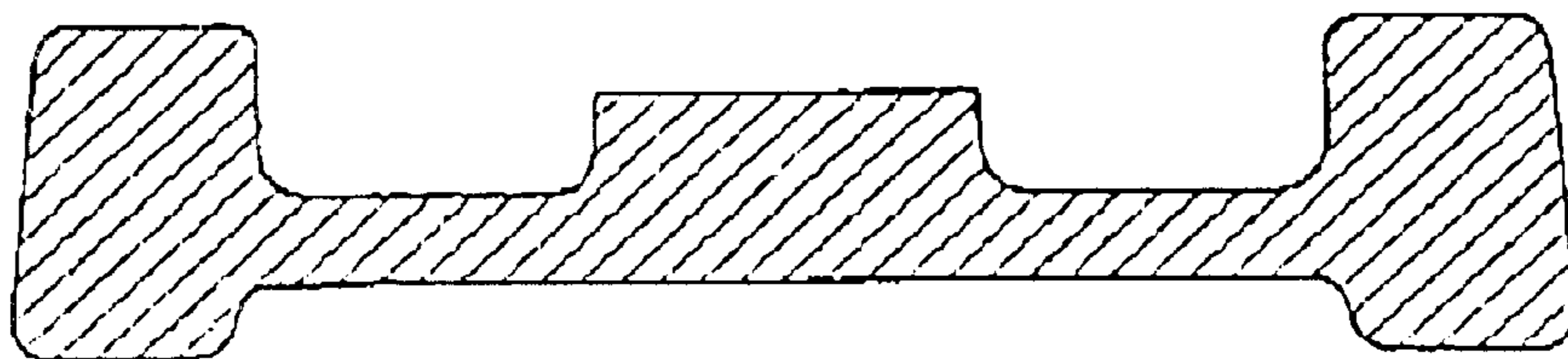

FIG. 6

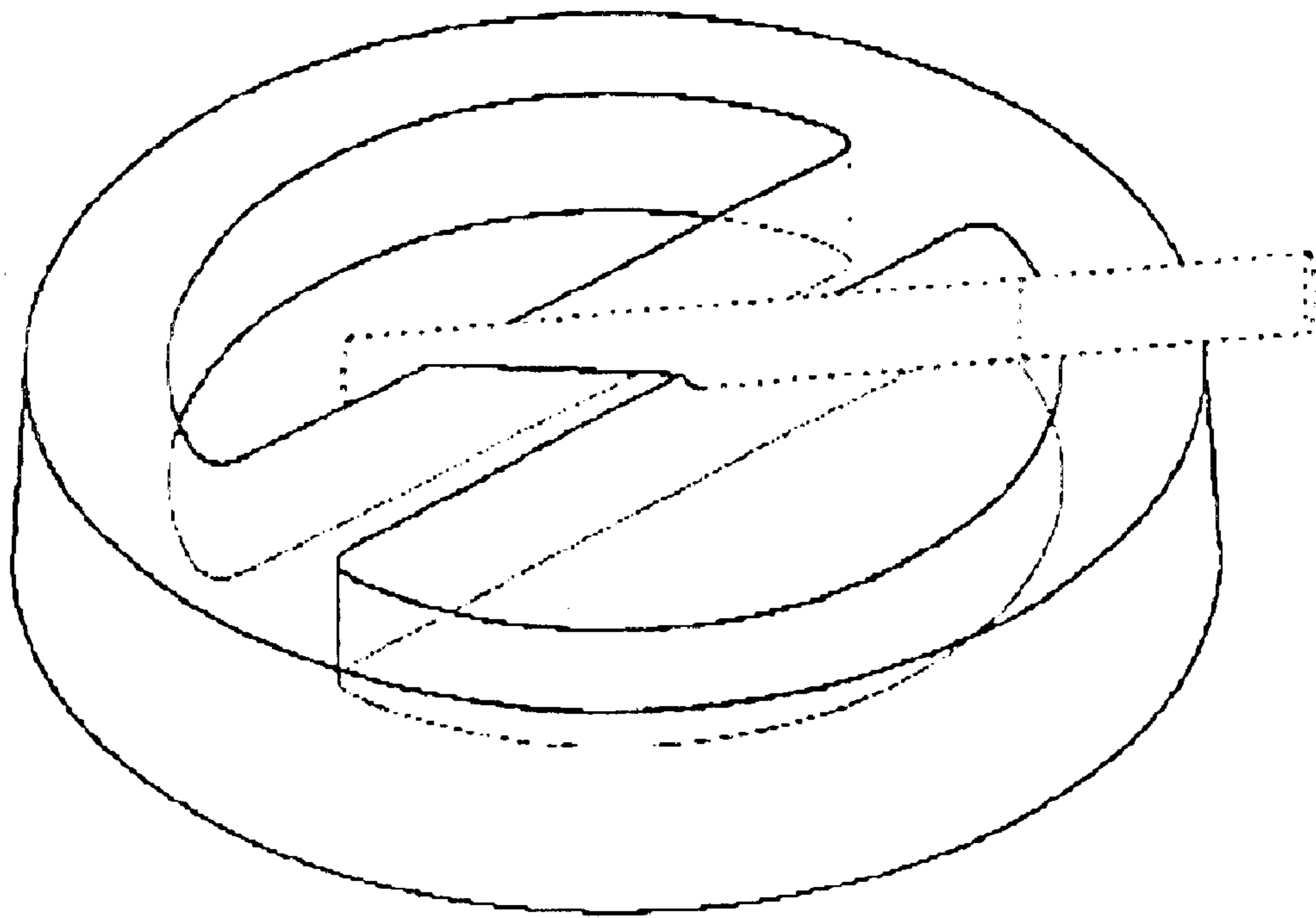

FIG. 7