

US00D500139S

(12) **United States Design Patent**  
**Bender**

(10) **Patent No.:** **US D500,139 S**

(45) **Date of Patent:** **\*\* Dec. 21, 2004**

(54) **BABY BOTTLE WITH BASE**

(76) **Inventor:** **Gregory D. Bender**, 1817 Grandview Ave., Portsmouth, OH (US) 45662

(\*\*) **Term:** **14 Years**

(21) **Appl. No.:** **29/195,156**

(22) **Filed:** **Dec. 8, 2003**

(51) **LOC (7) Cl.** ..... **07-01**

(52) **U.S. Cl.** ..... **D24/197**

(58) **Field of Search** ..... D24/197, 199;  
215/11.1, 11.2, 11.3, 11.4, 11.5, 11.6; 248/102,  
103, 104, 105, 106, 107

(56) **References Cited**

**U.S. PATENT DOCUMENTS**

D375,794 S	*	11/1996	Bender	.....	D24/197
D402,372 S	*	12/1998	Burchett et al.	.....	D24/197
D404,493 S	*	1/1999	Varlet	.....	D24/197
D470,593 S	*	2/2003	Iodice	.....	D24/197
D477,529 S	*	7/2003	Chan	.....	D9/307
D477,668 S	*	7/2003	Kipperman et al.	.....	D24/197

\* cited by examiner

*Primary Examiner*—Ian Simmons

*Assistant Examiner*—Sally Shih

(74) *Attorney, Agent, or Firm*—Jason H. Foster; Kremblas, Foster, Phillips & Pollick

(57) **CLAIM**

The ornamental design for a baby bottle with base, as shown.

**DESCRIPTION**

FIG. 1 is a front perspective view of a baby bottle with the base showing my new design.

FIG. 2 is a top view thereof.

FIG. 3 is a bottom view thereof.

FIG. 4 is a side view thereof. The opposite side view is substantially identical.

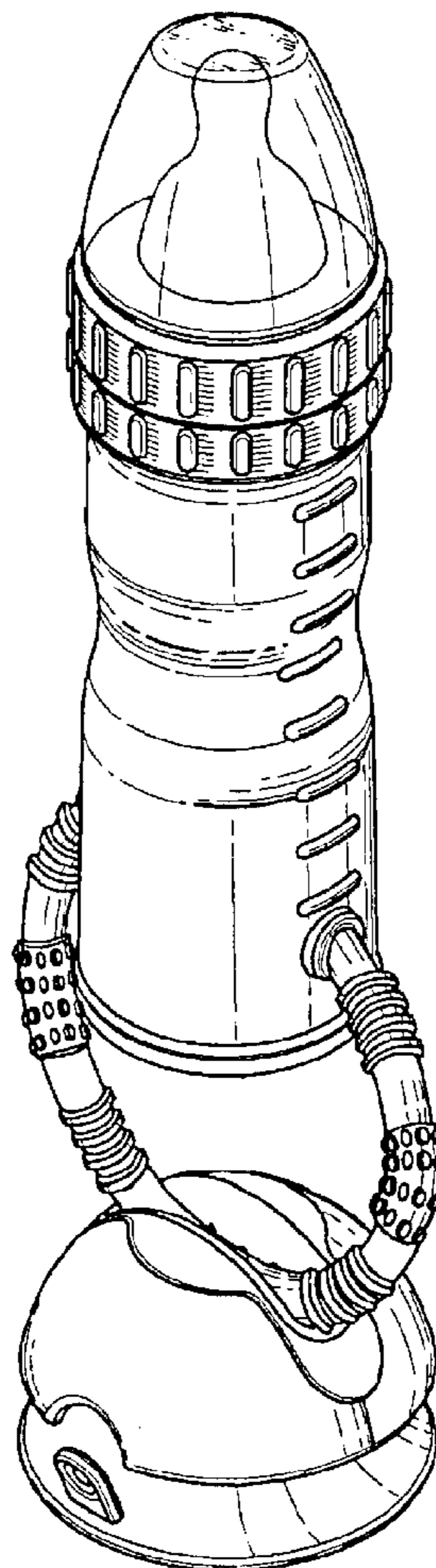
FIG. 5 is a back view thereof.

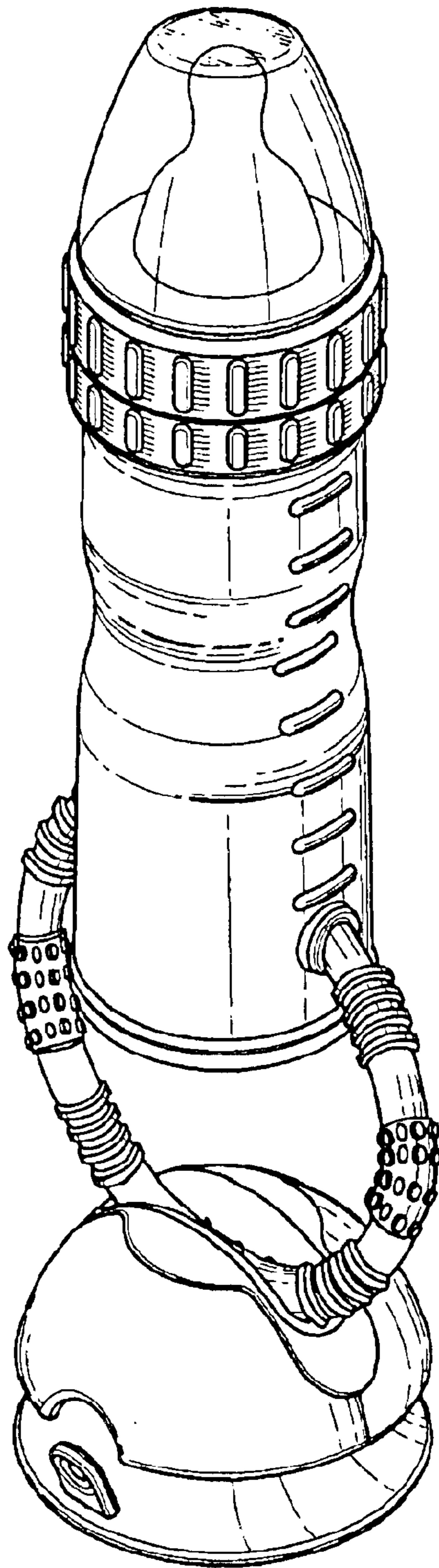
FIG. 6 is a front view thereof.

FIG. 7 is an exploded view of the baby bottle; and,

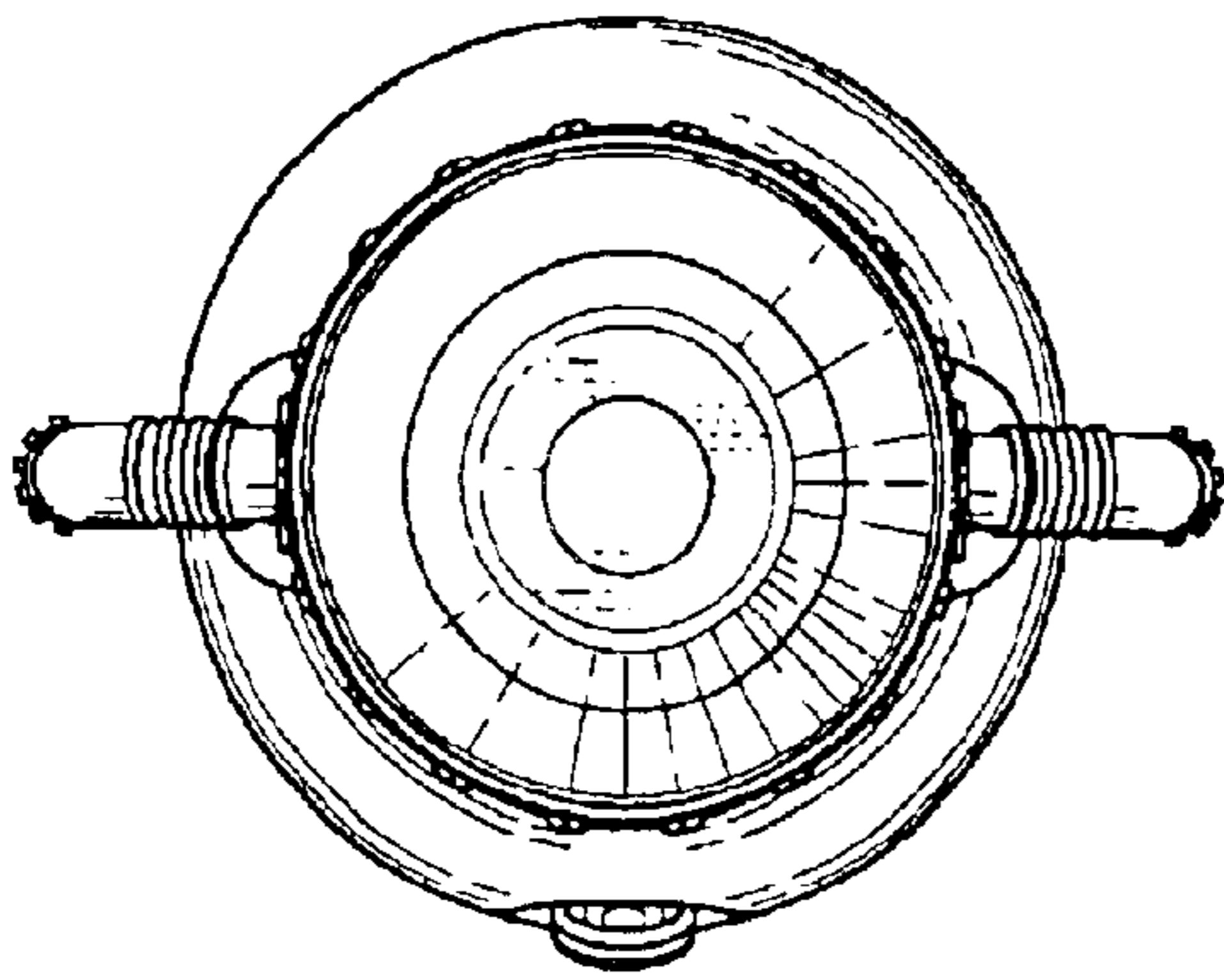
FIG. 8 is an exploded view of the base.

**1 Claim, 5 Drawing Sheets**

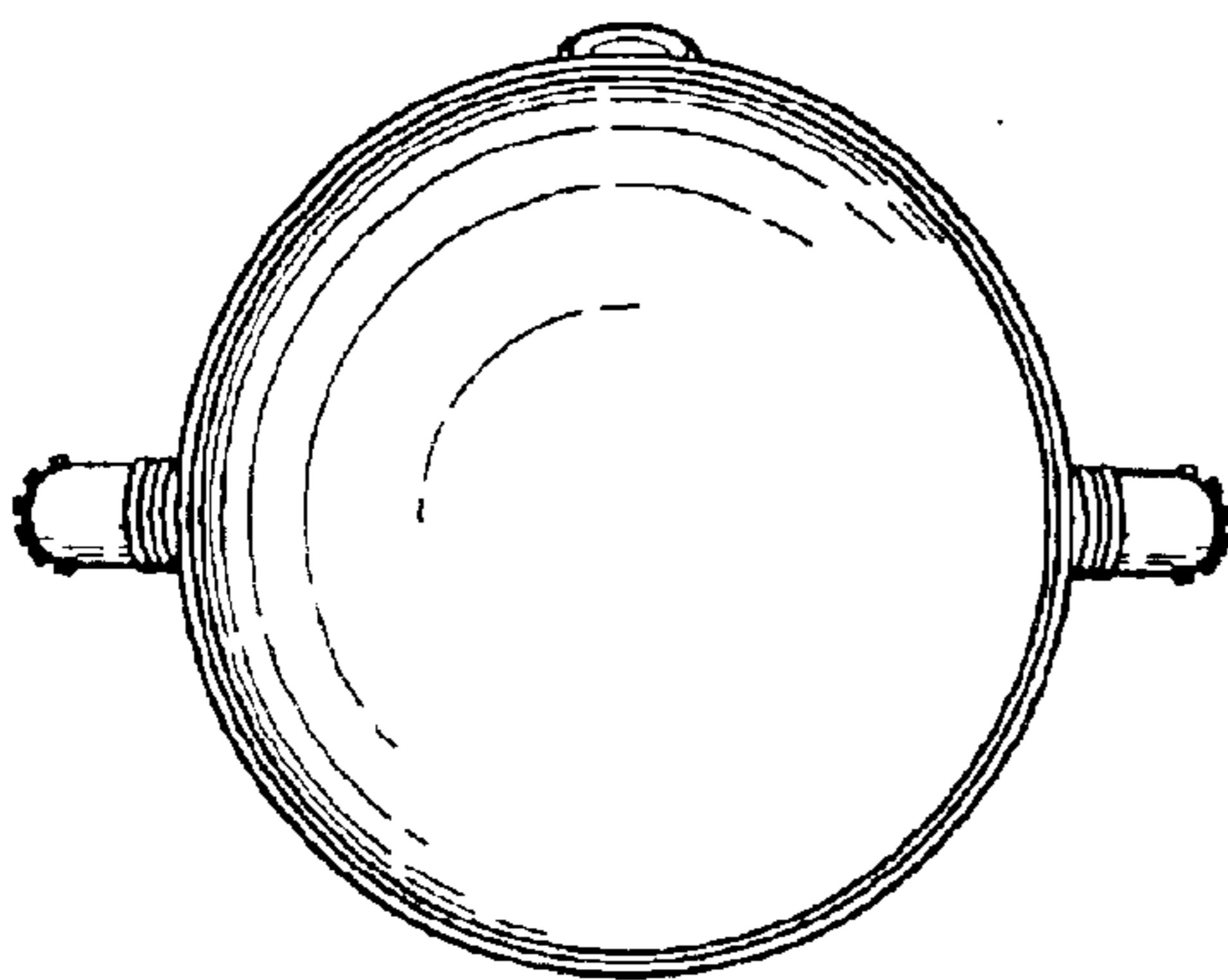




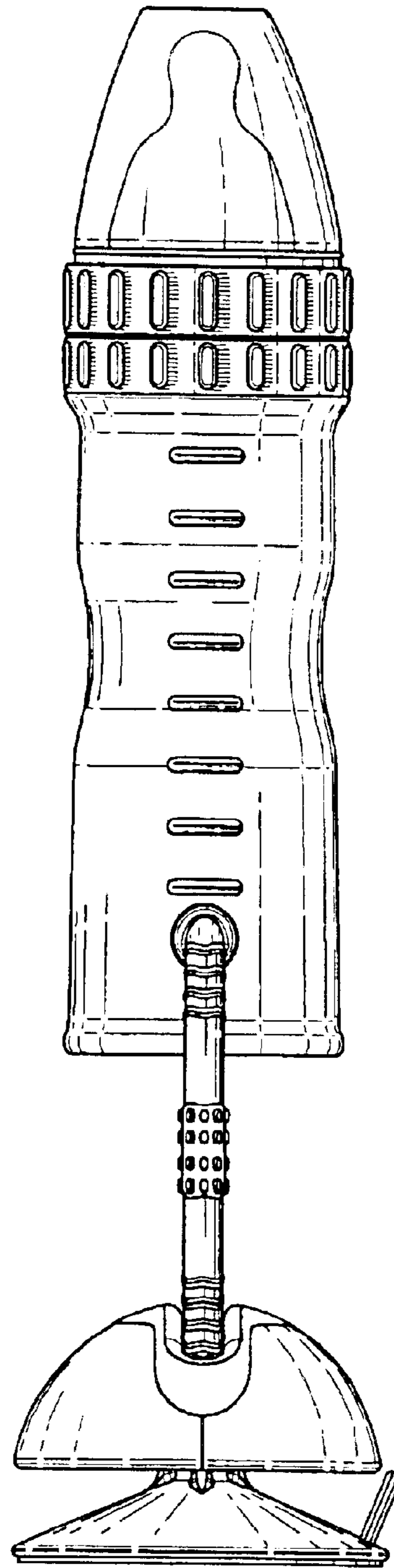
*Fig. 1*



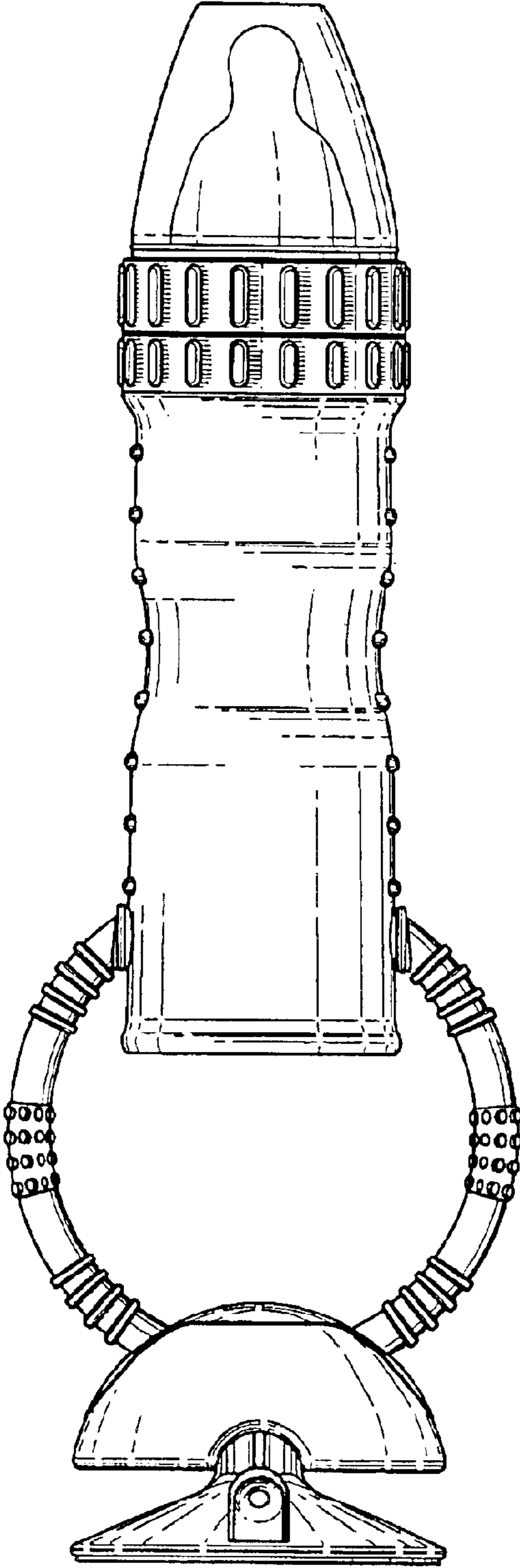
*Fig. 2*



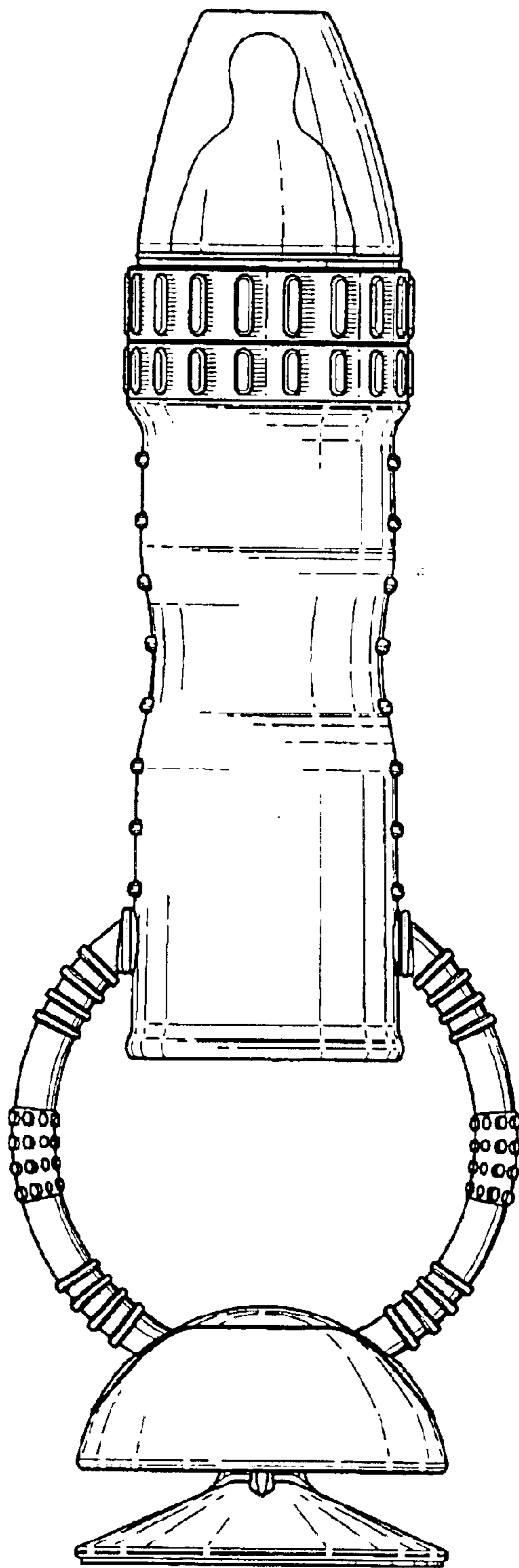
*Fig. 3*



*Fig. 4*



*Fig. 5*



*Fig. 6*

