



US00D500092S

(12) **United States Design Patent**
Carbonero

(10) **Patent No.:** **US D500,092 S**
(45) **Date of Patent:** **** Dec. 21, 2004**

(54) **LAUNCHING BASE FOR EYE-HAND COORDINATION GAME**

6,159,112 A * 12/2000 Ciluffo et al. 473/451
D442,229 S * 5/2001 Chiang D21/312

(75) Inventor: **Kurt K. Carbonero**, Rochester, MI (US)

(73) Assignee: **Pull-Buoy, Inc.**, Sterling Heights, MI (US)

(**) Term: **14 Years**

(21) Appl. No.: **29/196,852**

(22) Filed: **Jan. 6, 2004**

(51) **LOC (7) Cl.** **21-01**

(52) **U.S. Cl.** **D21/301; D21/454**

(58) **Field of Search** D21/300-302,
D21/312, 322, 453, 454, 385; 124/4, 5,
6, 79, 41.1; 446/61, 63, 64; 273/317, 329,
330, 410, 108; 473/505, 516, 569

(56) **References Cited**

U.S. PATENT DOCUMENTS

191,628 A * 6/1877 Wilkie 124/4
D138,093 S * 6/1944 Schlitz D21/385
D177,880 S * 5/1956 Steiner D21/454
3,031,797 A * 5/1962 Gelfand 446/65
3,912,271 A * 10/1975 Stevenson 273/317
D326,479 S * 5/1992 Scarpelli D21/449
D327,098 S * 6/1992 Bisko D21/385
5,207,421 A * 5/1993 Gorvin 124/79

OTHER PUBLICATIONS

Gym Closet, 2000, p. 48, Sterling Heights, Michigan, submitted in color.

* cited by examiner

Primary Examiner—Prabhakar Deshmukh

(74) *Attorney, Agent, or Firm*—Reising, Ethington, Barnes, Kisselle, P.C.

(57) **CLAIM**

The ornamental design for a launching base for an eye-hand coordination game, as shown and described.

DESCRIPTION

FIG. 1 is a perspective view of a launching base for an eye-hand coordination game;
FIG. 2 is a top view of the launching base for an eye-hand coordination game;
FIG. 3 is a bottom view of the launching base for an eye-hand coordination game;
FIG. 4 is a side view of the launching base for an eye-hand coordination game;
FIG. 5 is a rear view of the launching base for an eye-hand coordination game; and,
FIG. 6 is a front view of the launching base for an eye-hand coordination game.

1 Claim, 3 Drawing Sheets

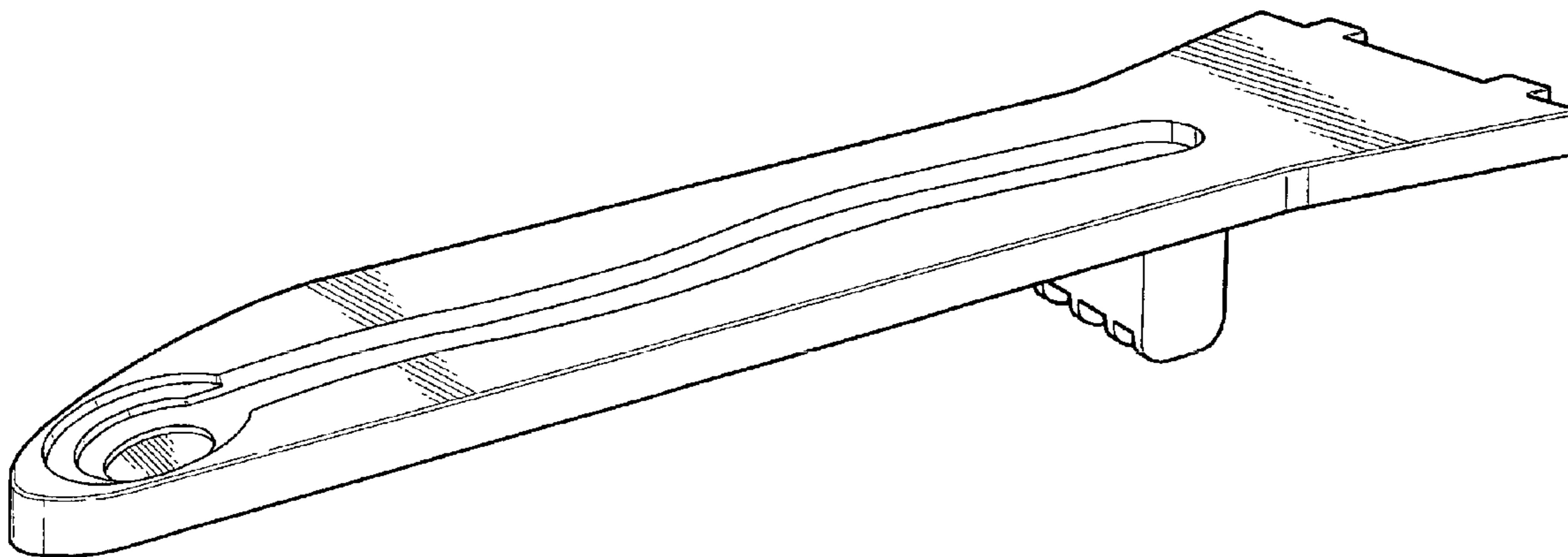

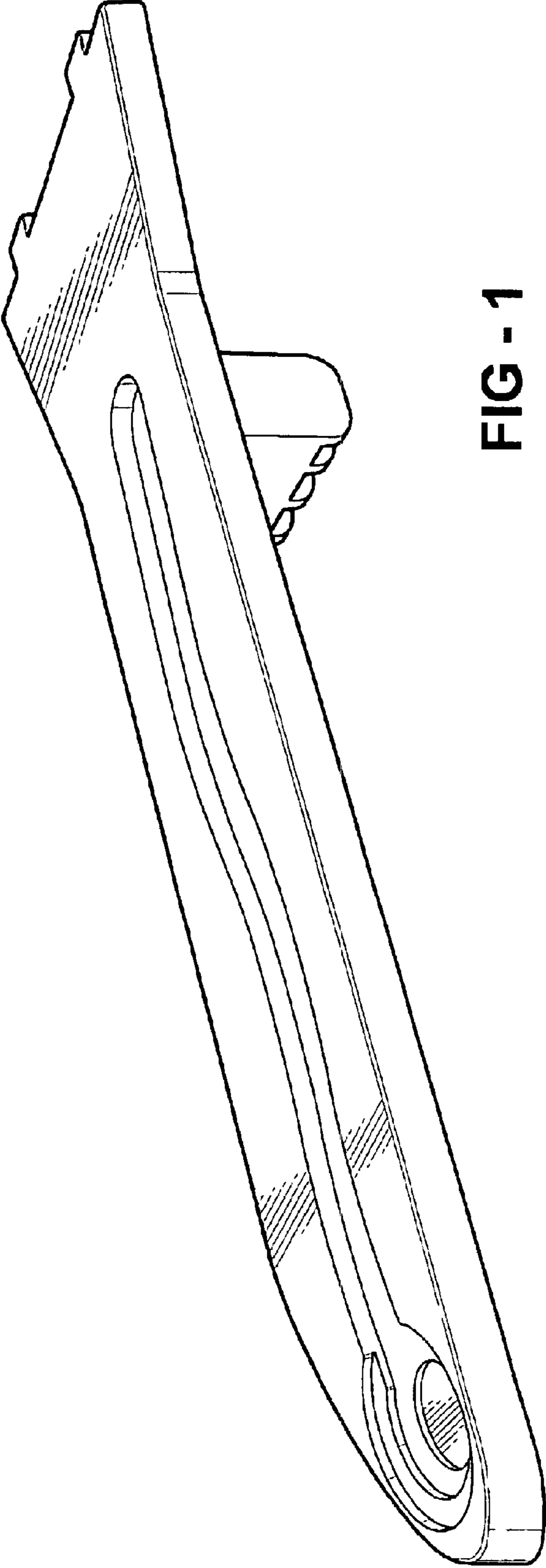

FIG - 1

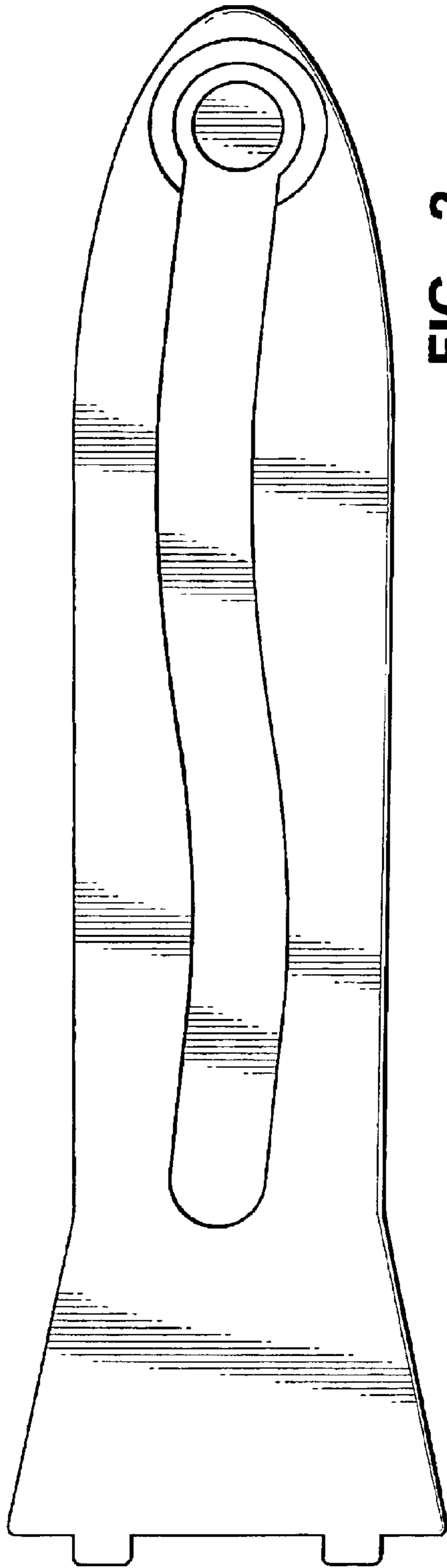

FIG - 2

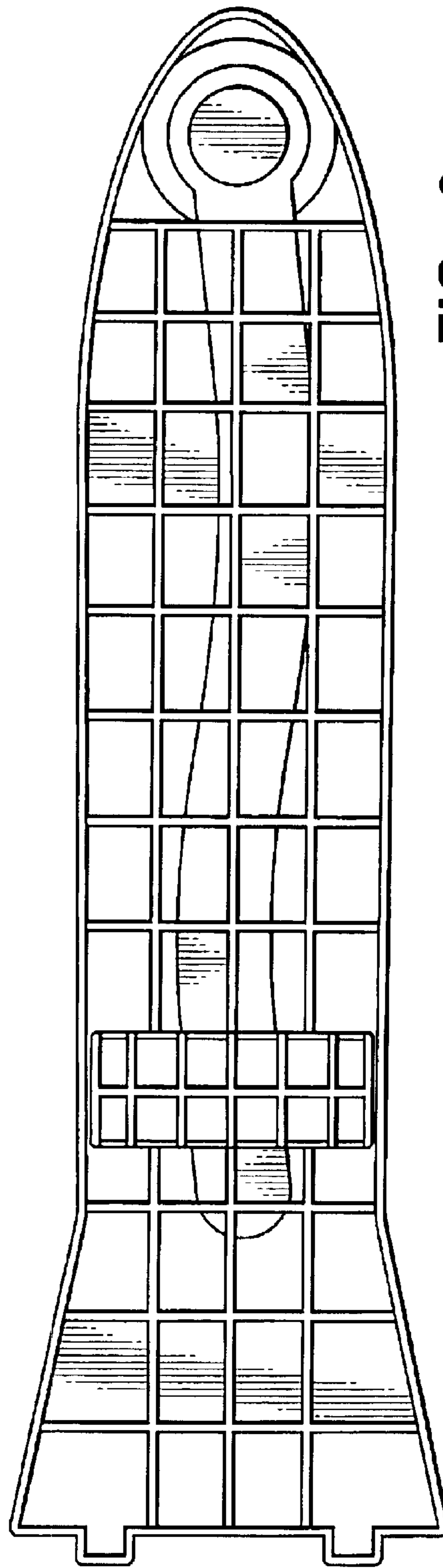

FIG - 3

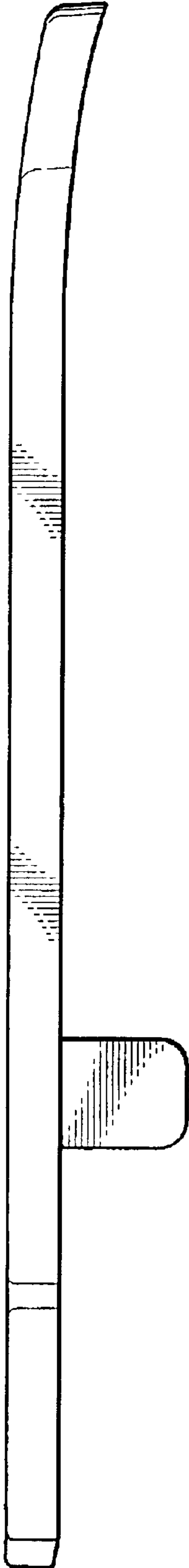

FIG - 4

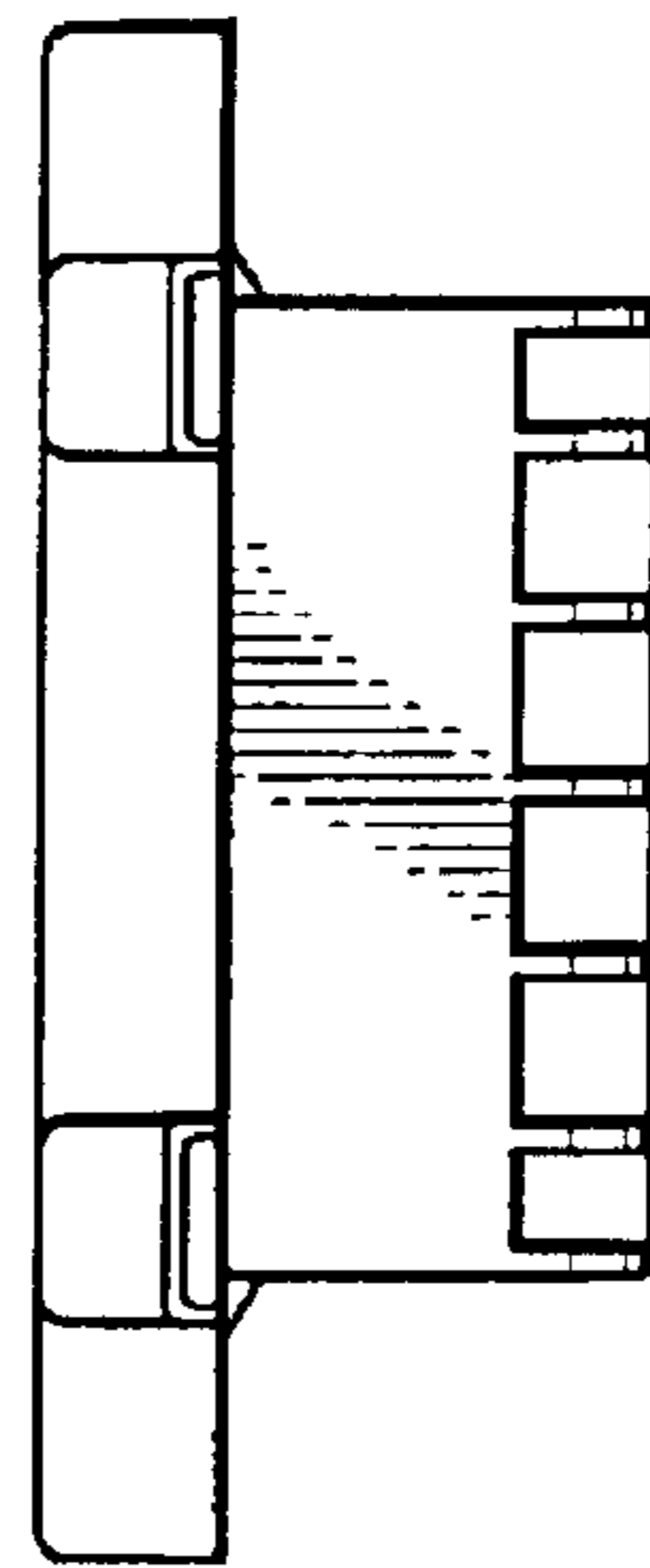

FIG - 5

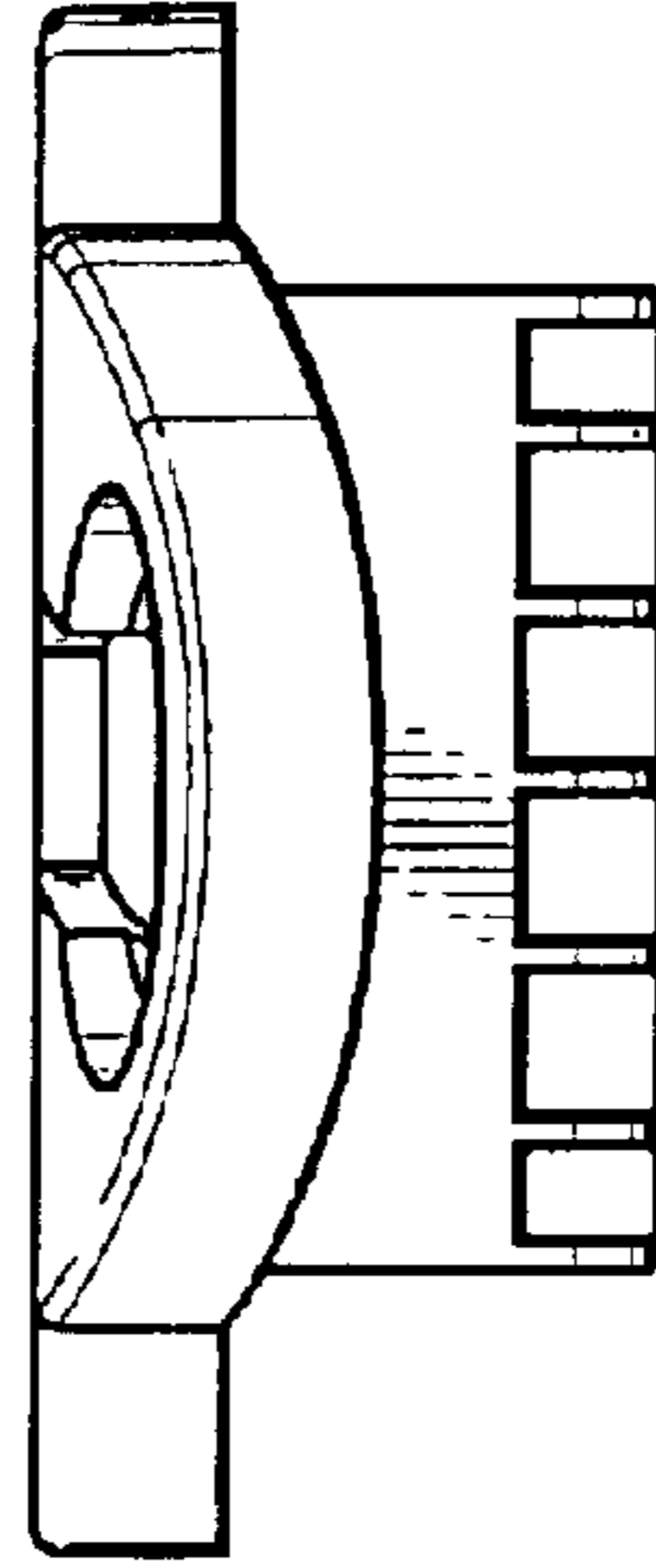

FIG - 6