

US00D500073S

(12) **United States Design Patent**
Rousseau

(10) **Patent No.:** **US D500,073 S**

(45) **Date of Patent:** **** Dec. 21, 2004**

(54) **PRINT DRUM MAINTENANCE UNIT**

D366,276 S * 1/1996 Yasuda D18/43
D463,817 S * 10/2002 Kunihiro et al. D18/40

(75) Inventor: **Gerard H. Rousseau**, Portland, OR
(US)

* cited by examiner

(73) Assignee: **Xerox Corporation**, Stamford, CT
(US)

Primary Examiner—Caron D. Veynar

(74) *Attorney, Agent, or Firm*—Manuel Quiogue

(**) Term: **14 Years**

(57) **CLAIM**

The ornamental design for a print drum maintenance unit, as shown and described.

(21) Appl. No.: **29/196,224**

(22) Filed: **Dec. 22, 2003**

DESCRIPTION

(51) **LOC (7) Cl.** **16-03**

(52) **U.S. Cl.** **D18/40**

(58) **Field of Search** D18/12, 40, 43,
D18/56; D14/471, 481, 483; 222/DIG. 1;
399/24-31, 110-125, 252-262; 400/207,
208; D9/500, 520; 209/447

FIG. 1 is a perspective view illustrating the new design;
FIG. 2 is a front elevational view of the new design.
FIG. 3 is a right side elevational view of the new design.
FIG. 4 is a rear elevational view of the new design.
FIG. 5 is a left side elevational view of the new design.
FIG. 6 is a top plan view of the new design; and,
FIG. 7 is a bottom plan view of the new design.
The broken line showing of certain portions of the print
drum maintenance unit is for illustrative purposes only and
forms no part of the claimed design.

(56) **References Cited**

U.S. PATENT DOCUMENTS

D366,275 S * 1/1996 Komaki D18/43

1 Claim, 7 Drawing Sheets

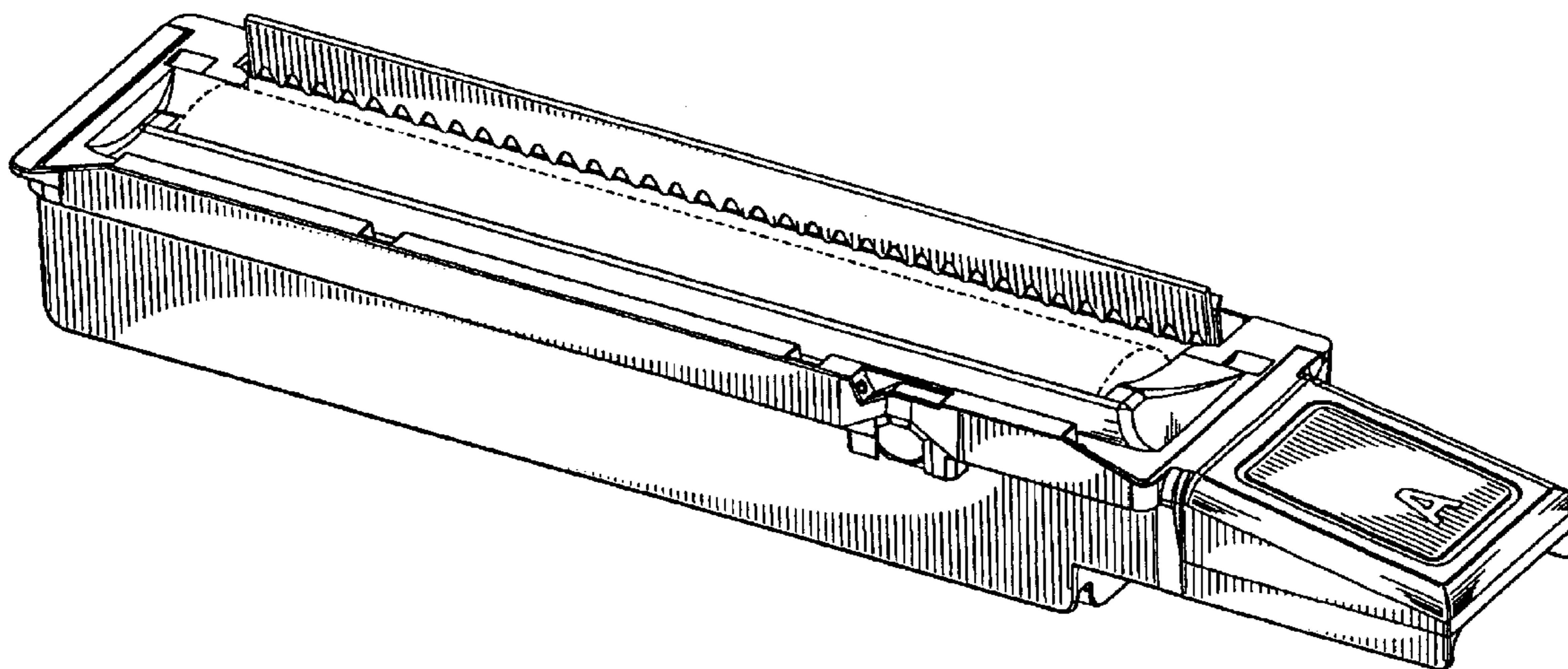

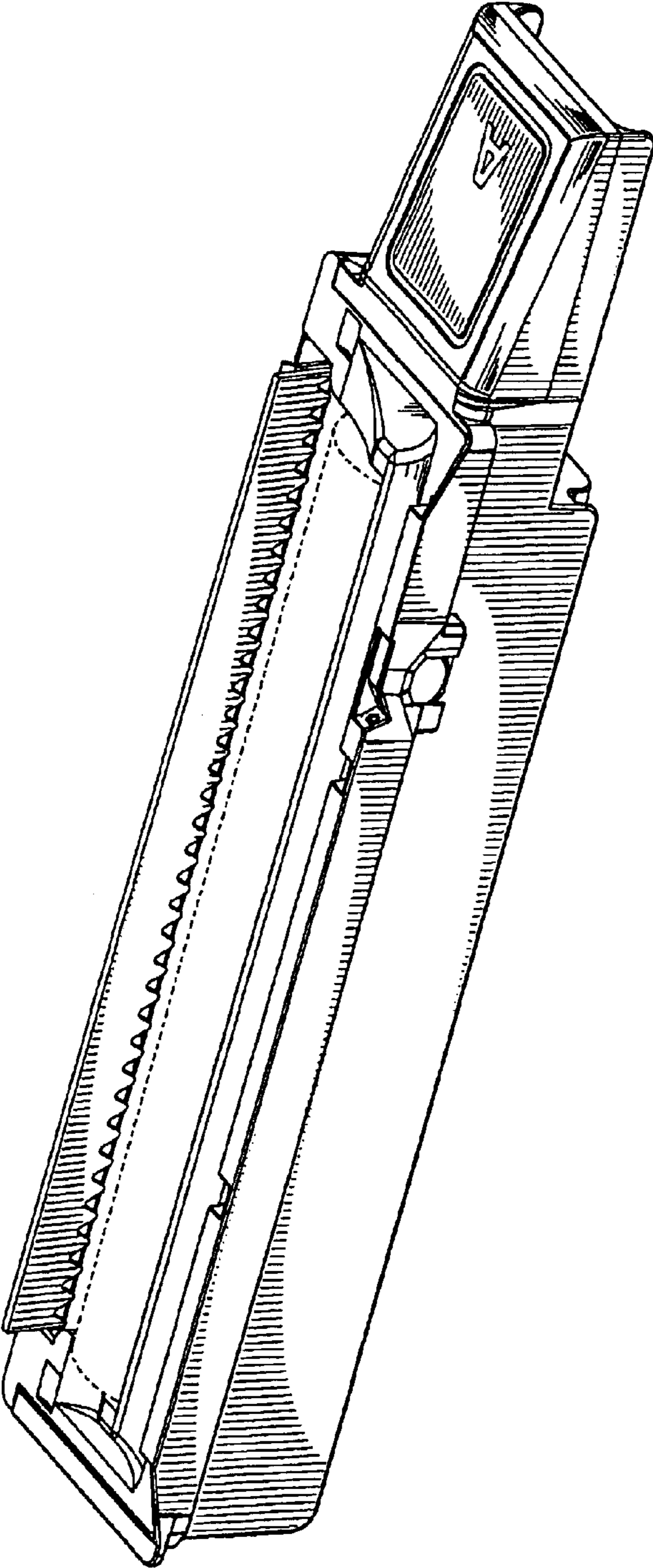

FIG. 1

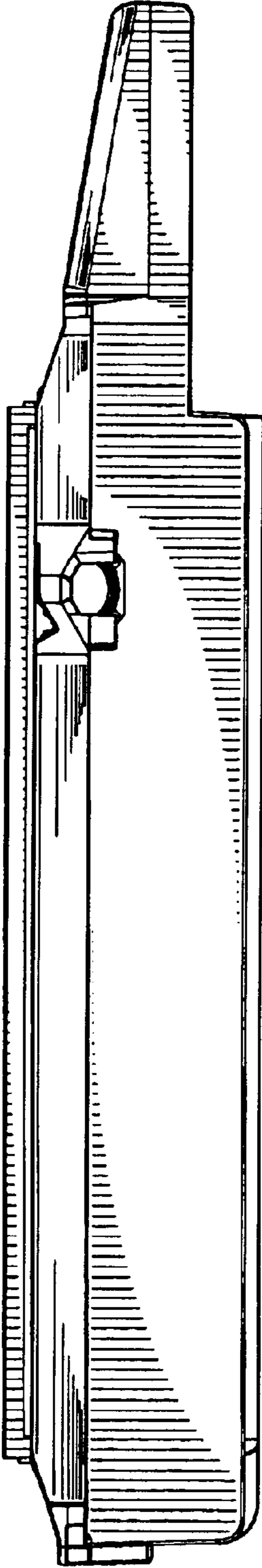

FIG. 2

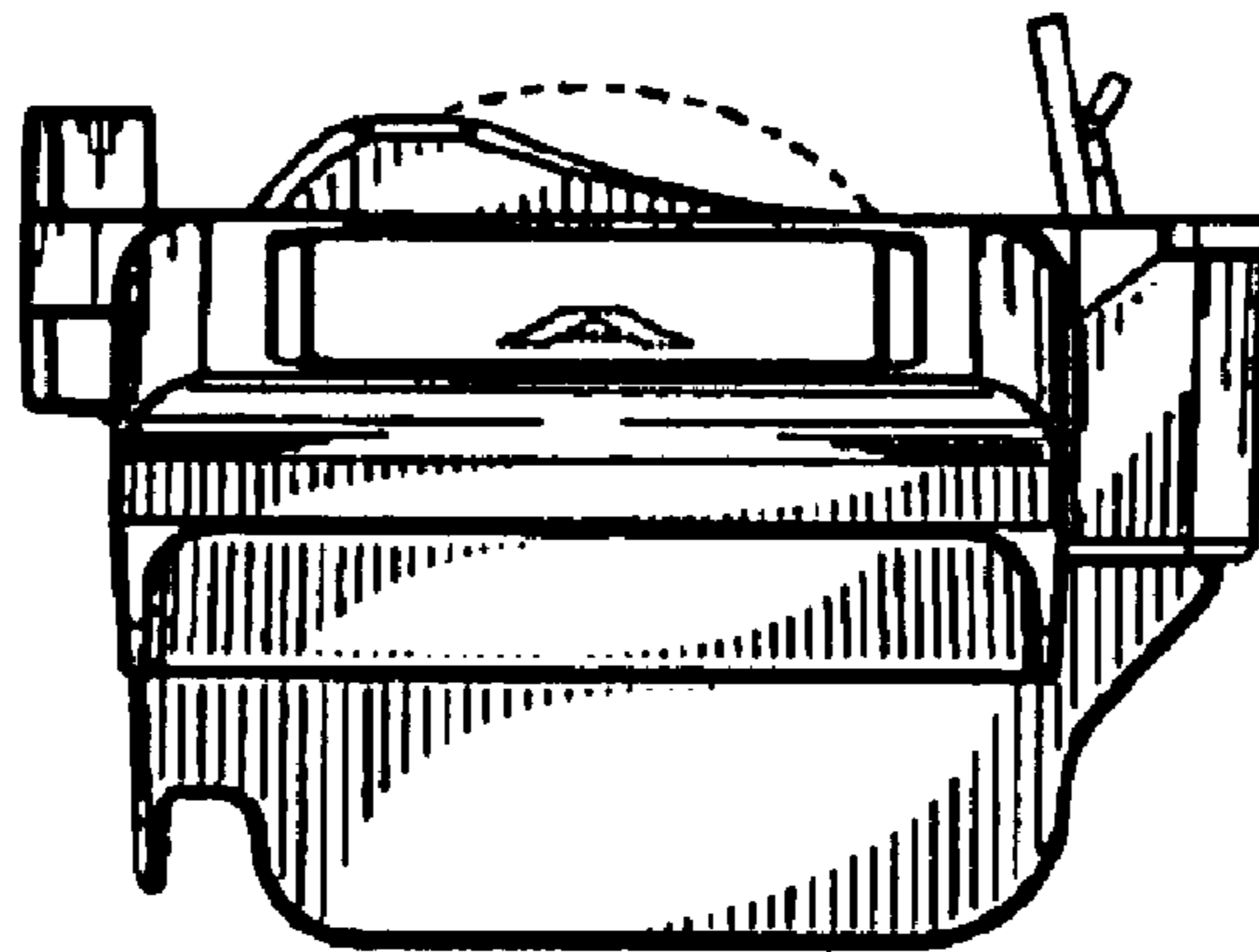

FIG. 3

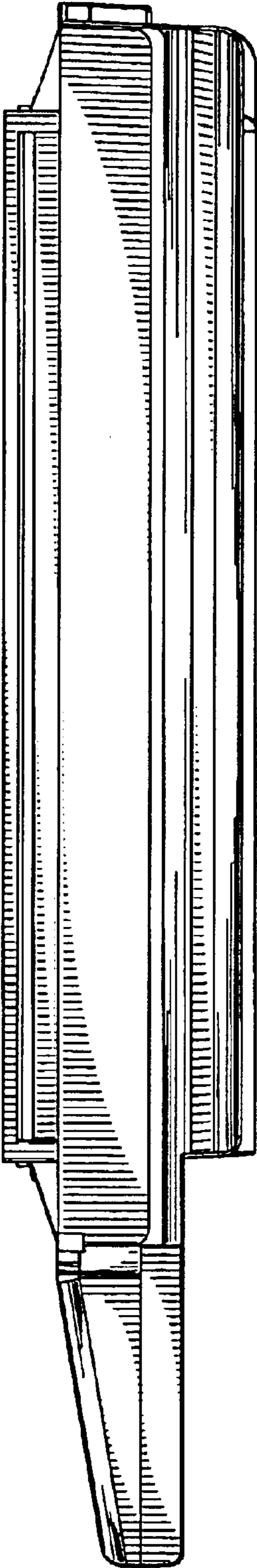

FIG. 4

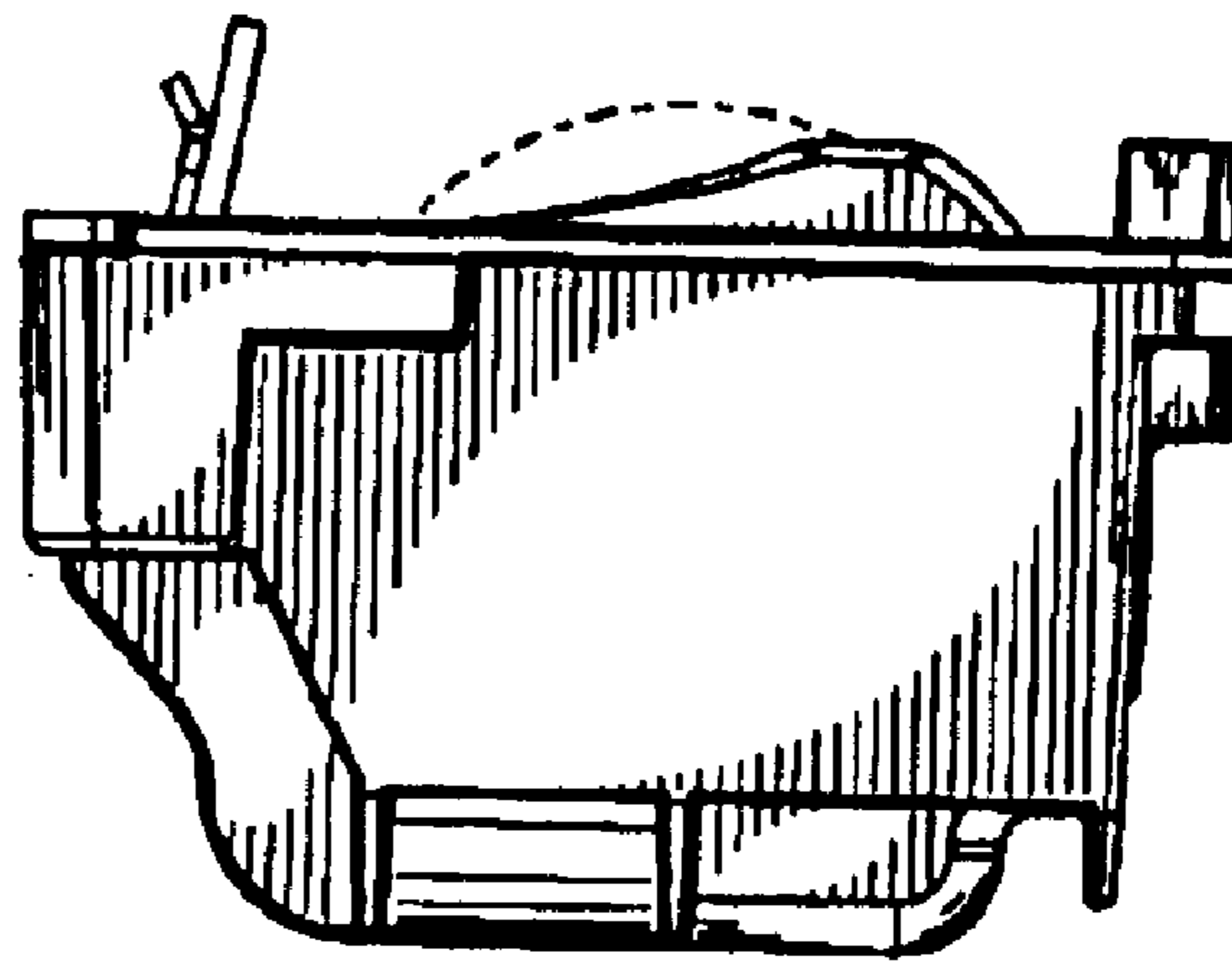

FIG. 5

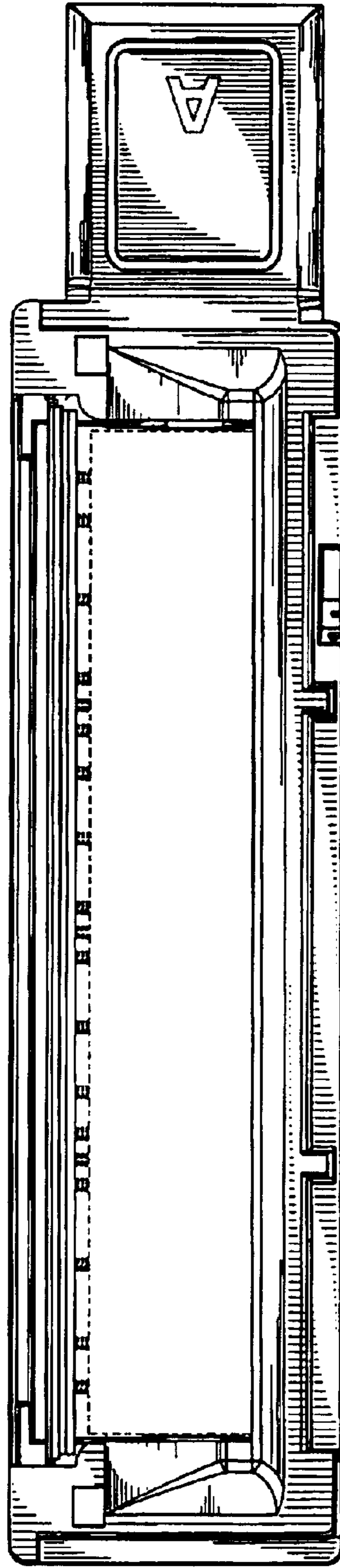

FIG. 6

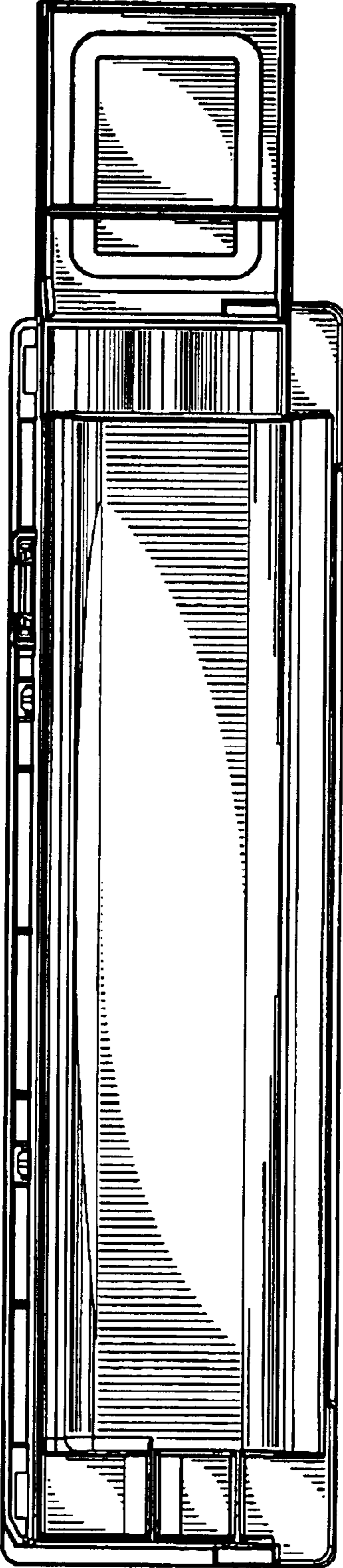

FIG. 7