



US00D499912S

(12) **United States Design Patent**  
**Mohundro**

(10) **Patent No.:** **US D499,912 S**  
(45) **Date of Patent:** **\*\* Dec. 21, 2004**

(54) **BED FOOTBOARD**

D475,862 S \* 6/2003 McDaniel et al. .... D6/393

(75) **Inventor:** **James Glenn Mohundro, Taichung (TW)**

**OTHER PUBLICATIONS**

Ethan Allen, c1998, p. 264, bed at lower right.\*

(73) **Assignee:** **Pacific Marketing International Co., Ltd., Taichung (TW)**

\* cited by examiner

(\*\*) **Term:** **14 Years**

*Primary Examiner*—Janice E. Seeger

(74) *Attorney, Agent, or Firm*—Rosenberg, Klein & Lee

(21) **Appl. No.:** **29/193,049**

(57) **CLAIM**

(22) **Filed:** **Nov. 4, 2003**

The ornamental design for a bed footboard, as shown and described.

(51) **LOC (7) Cl.** ..... **06-02**

(52) **U.S. Cl.** ..... **D6/505**

(58) **Field of Search** ..... D6/382–395, 505–508;  
5/53.1, 279.1, 280, 281, 907

**DESCRIPTION**

FIG. 1 is a front-bottom perspective view of a bed footboard, showing my new design;

FIG. 2 is a front elevation view thereof;

FIG. 3 is a rear elevation view thereof;

FIG. 4 is a left elevation view thereof;

FIG. 5 is a right elevation view thereof;

FIG. 6 is a top plan view thereof; and,

FIG. 7 is a bottom plan view thereof.

(56) **References Cited**

**U.S. PATENT DOCUMENTS**

D41,640 S	*	8/1911	Moore	.....	D6/395
D63,662 S	*	12/1923	Schmitt	.....	D6/393
D270,128 S	*	8/1983	Draheim	.....	D6/505
D400,034 S	*	10/1998	Zaidman	.....	D6/505
D472,068 S	*	3/2003	Risdon et al.	.....	D6/393

**1 Claim, 5 Drawing Sheets**

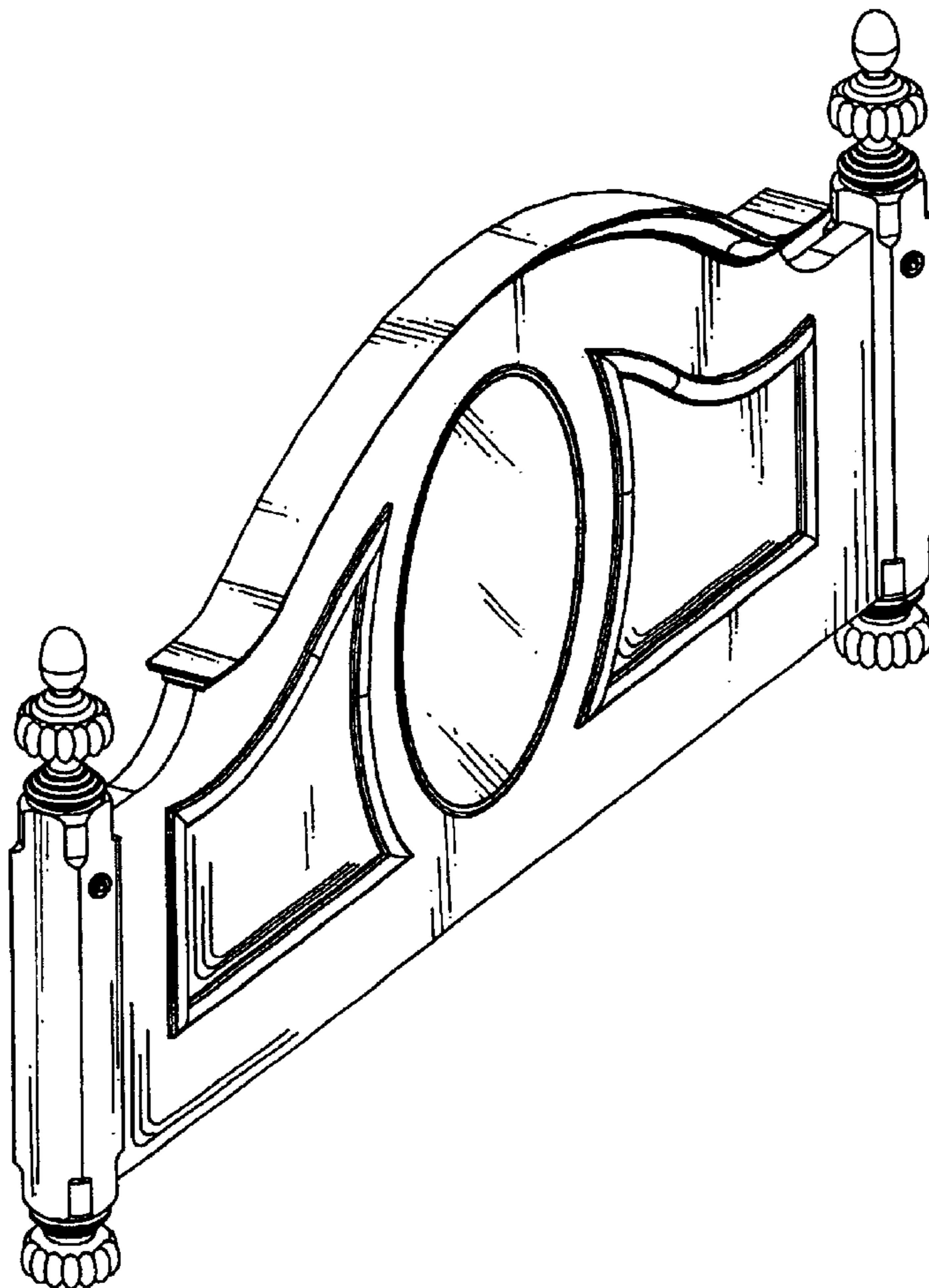

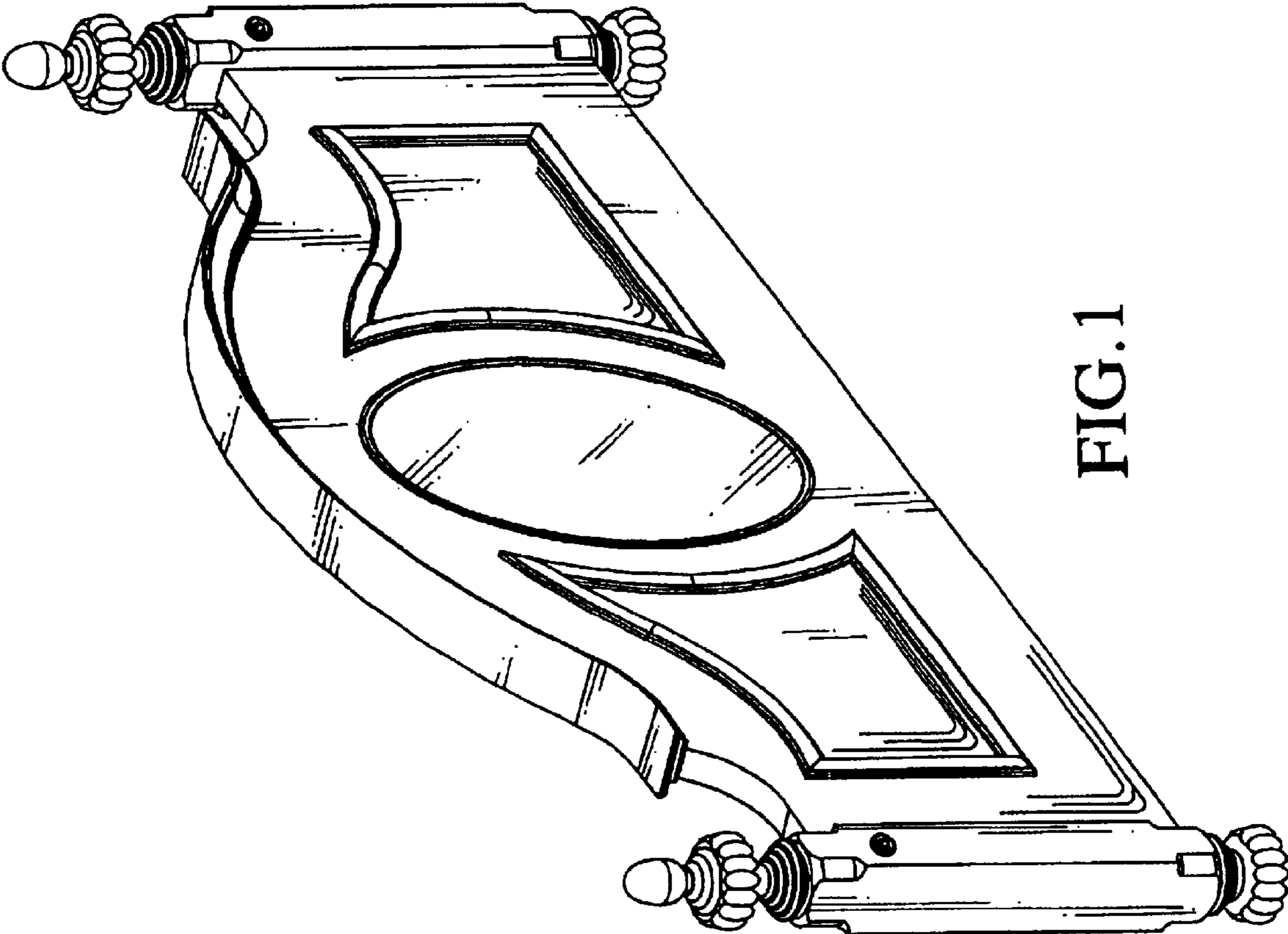

FIG. 1

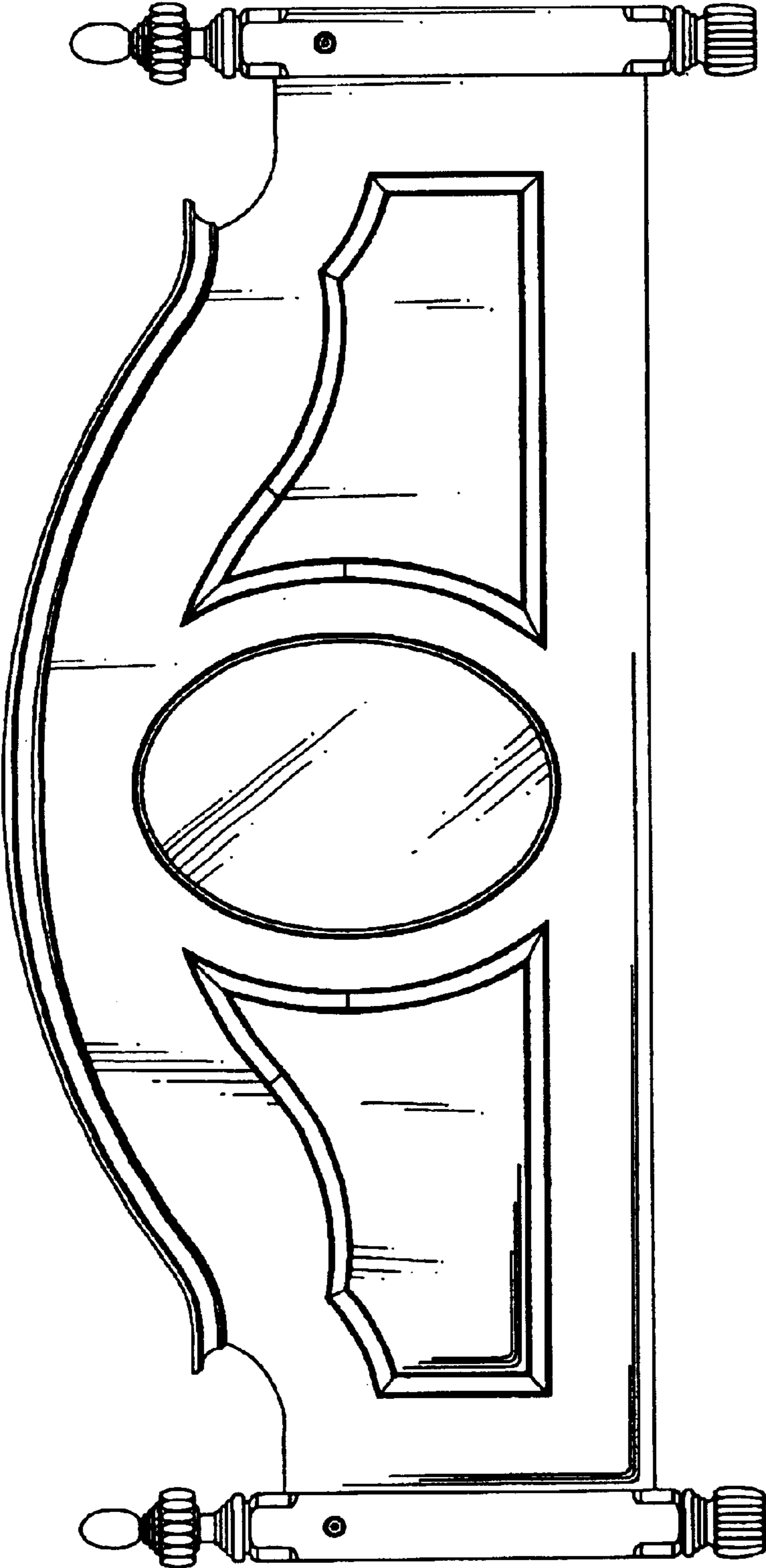

FIG. 2

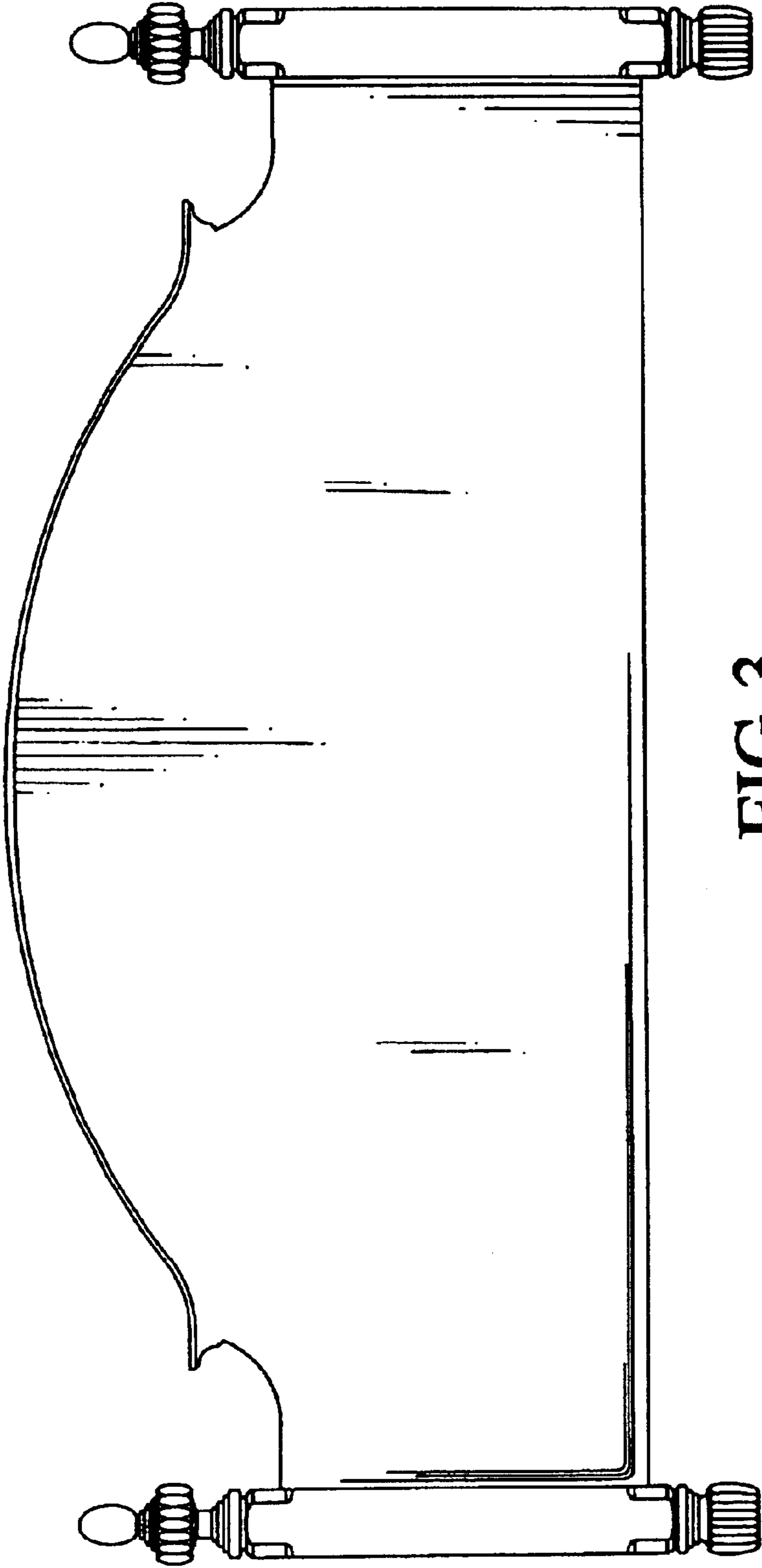

FIG.3

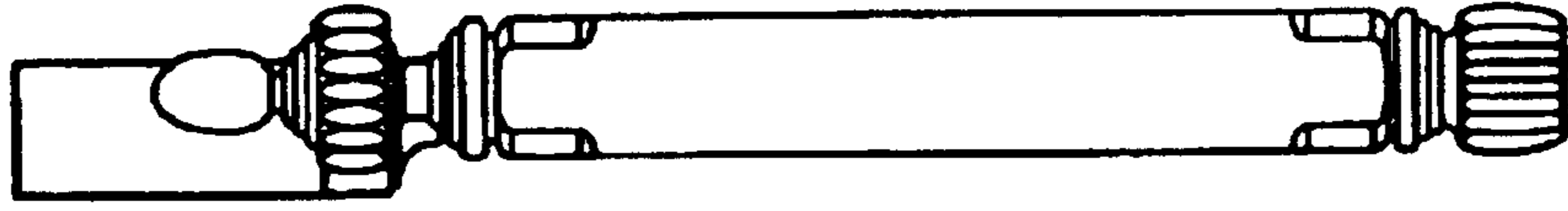

FIG. 5

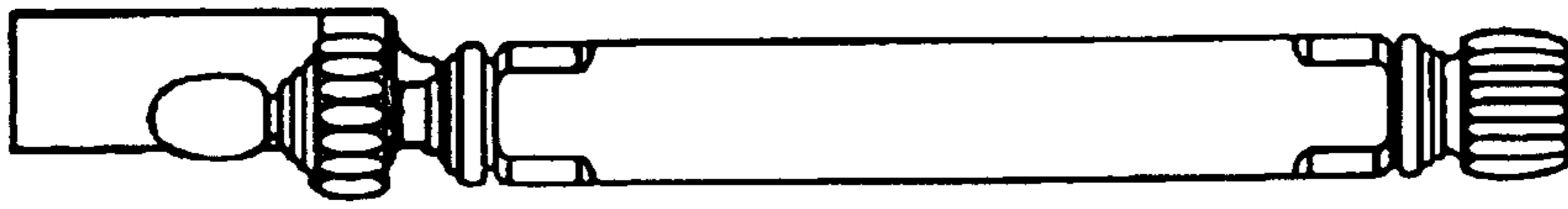

FIG. 4

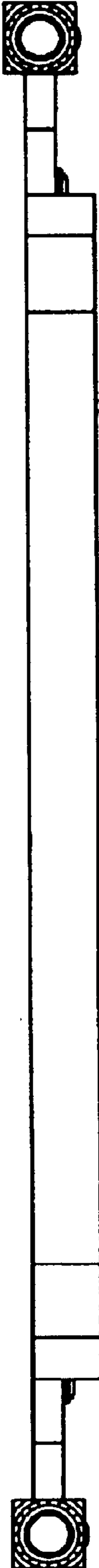

FIG. 6



FIG. 7