

US00D499899S

(12) **United States Design Patent**
Brought

(10) **Patent No.:** **US D499,899 S**

(45) **Date of Patent:** **** Dec. 21, 2004**

(54) **BOOK-READING STAND**

D404,933 S * 2/1999 Travers D6/419
5,979,857 A * 11/1999 Holm 248/451

(76) Inventor: **Jonathan L. Brought**, 934 SE. 226th,
Gresham, OR (US) 97030

* cited by examiner

(**) Term: **14 Years**

Primary Examiner—Janice E. Seeger

(21) Appl. No.: **29/194,905**

(57) **CLAIM**

(22) Filed: **Dec. 4, 2003**

The ornamental design for a book-reading stand, as shown and described.

(51) **LOC (7) Cl.** **06-06**

DESCRIPTION

(52) **U.S. Cl.** **D6/419**

(58) **Field of Search** D6/422–428, 419,
D6/420; 312/194–196; 248/441.1, 454,
460

FIG. 1 is a front view of a book-reading stand showing my new design.

FIG. 2 is a back view of the book-reading stand.

FIG. 3 is a left side view of the book-reading stand.

FIG. 4 is a right side view of the book-reading stand.

FIG. 5 is a top view of the book-reading stand; and,

FIG. 6 is a bottom view of the book-reading stand.

(56) **References Cited**

U.S. PATENT DOCUMENTS

D89,053 S * 1/1933 Mitchell D6/419
D362,130 S * 9/1995 Alba D6/399

1 Claim, 5 Drawing Sheets

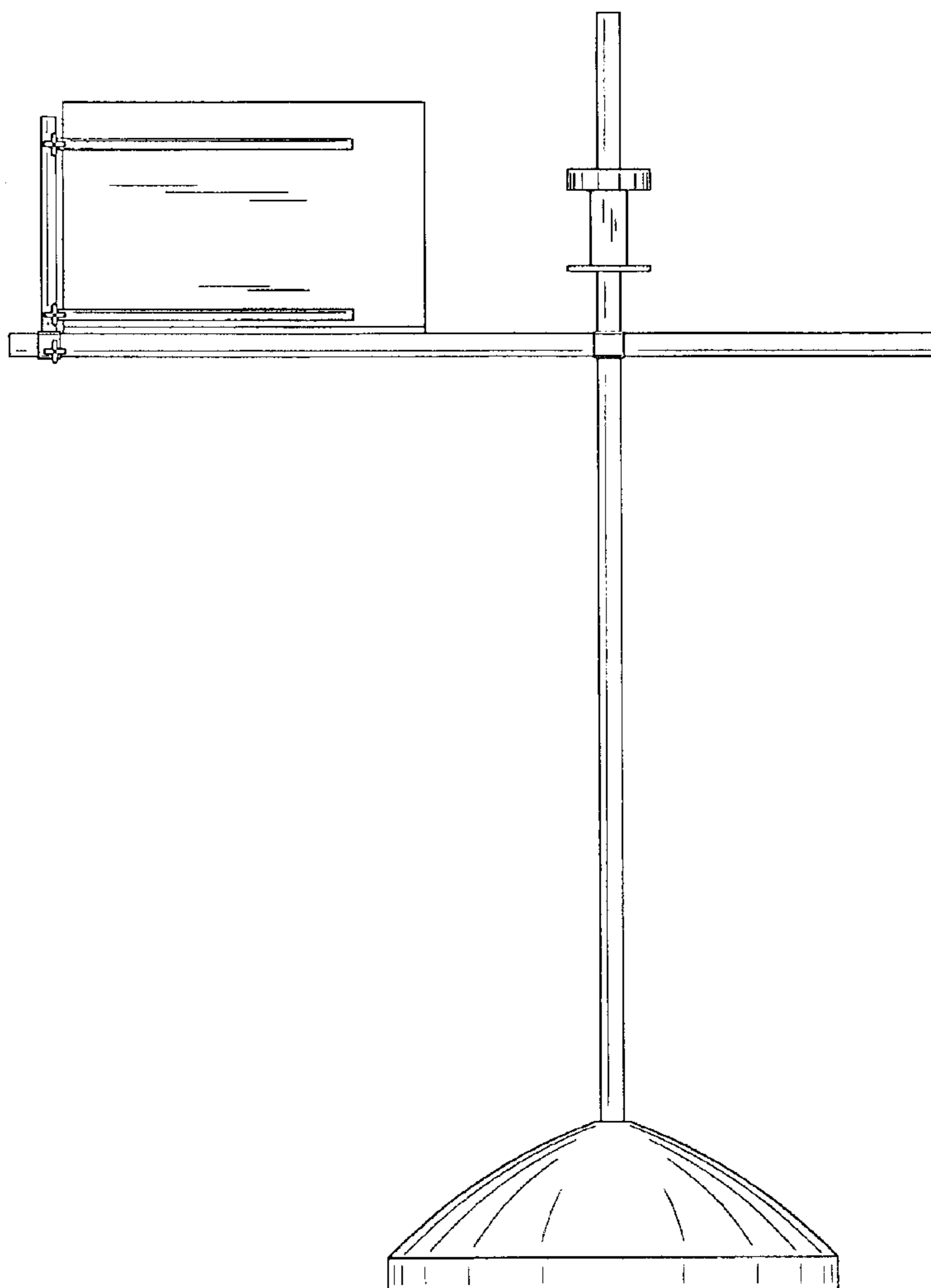

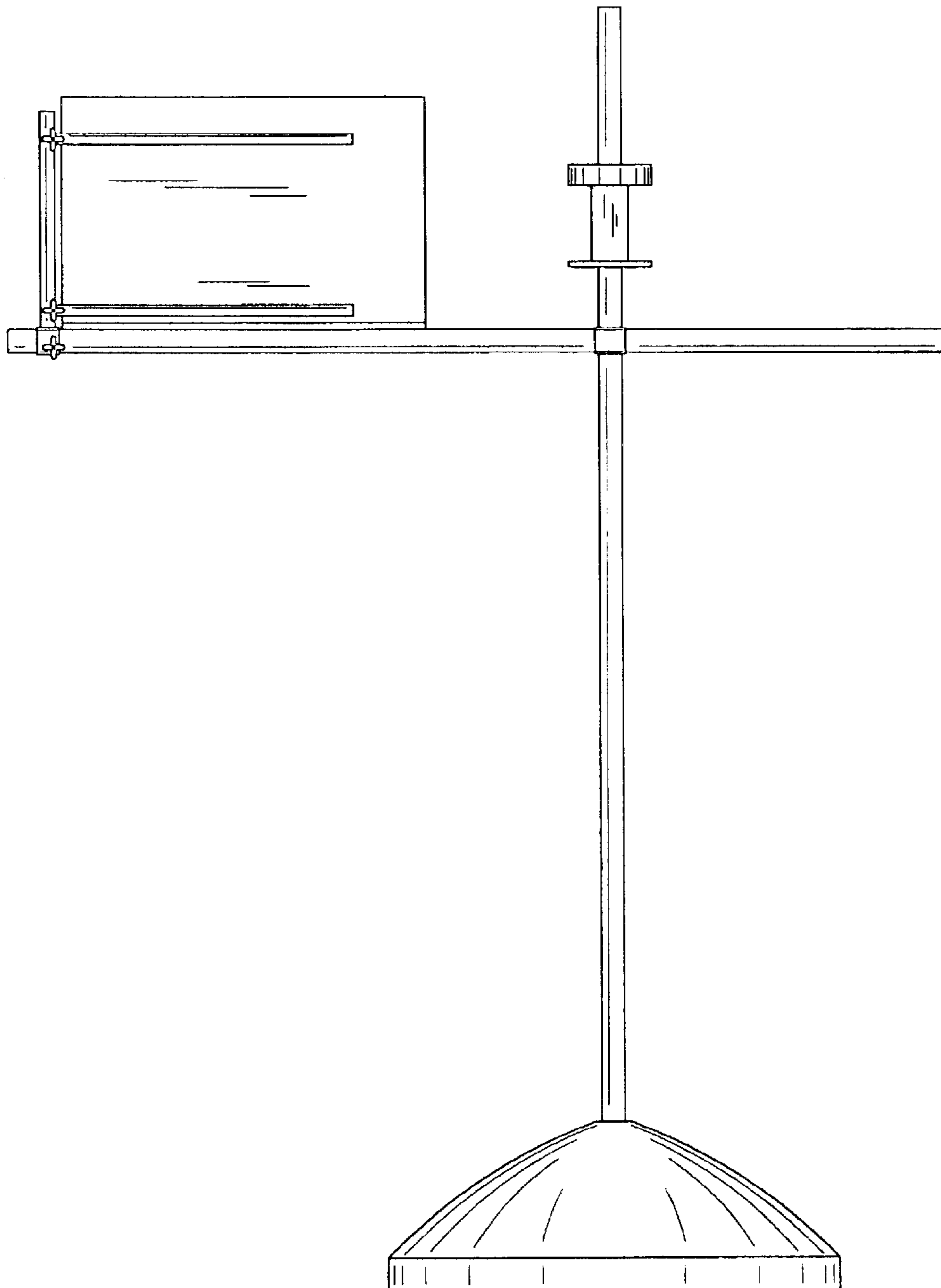

FIG. 1

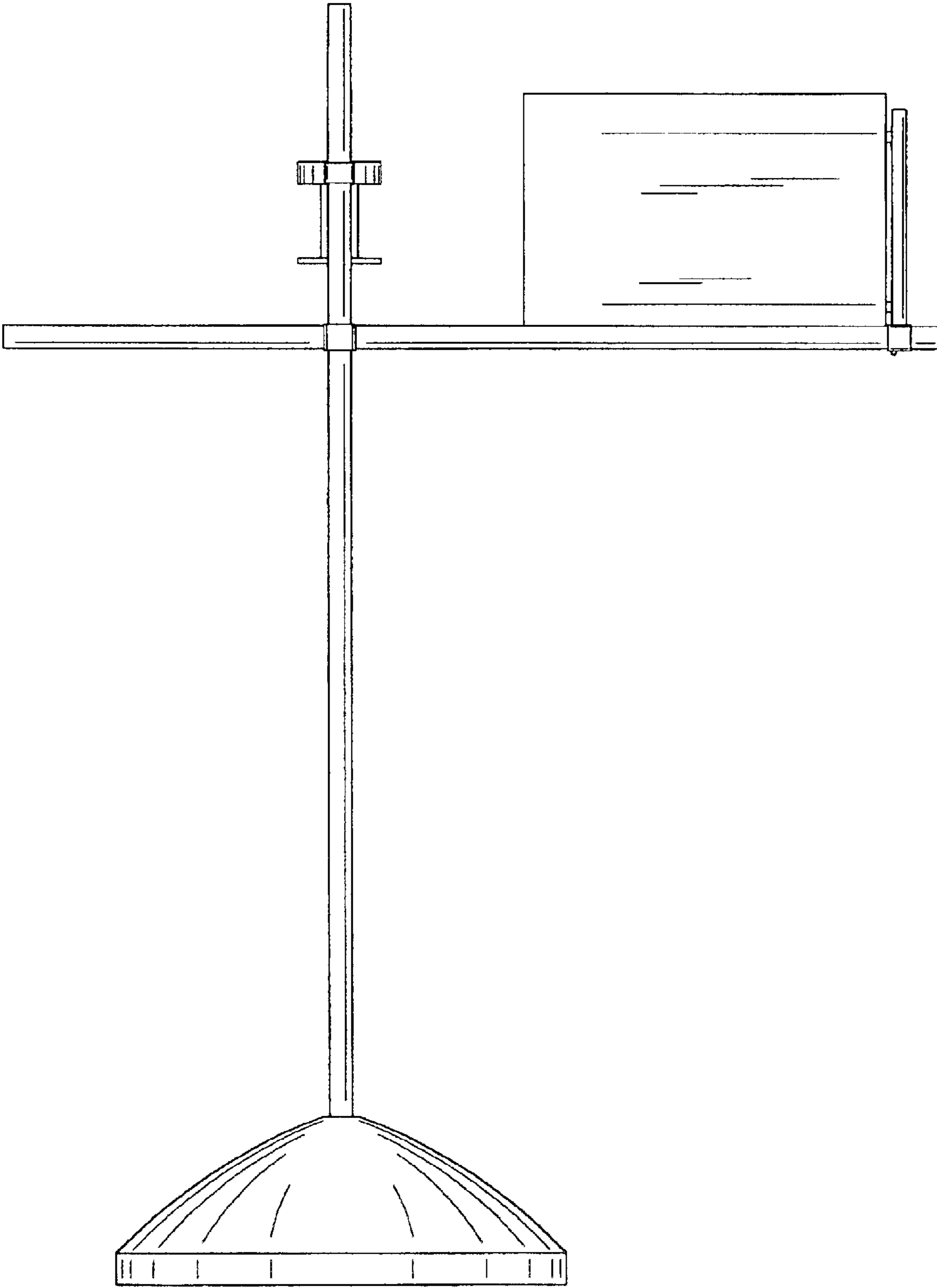

FIG. 2

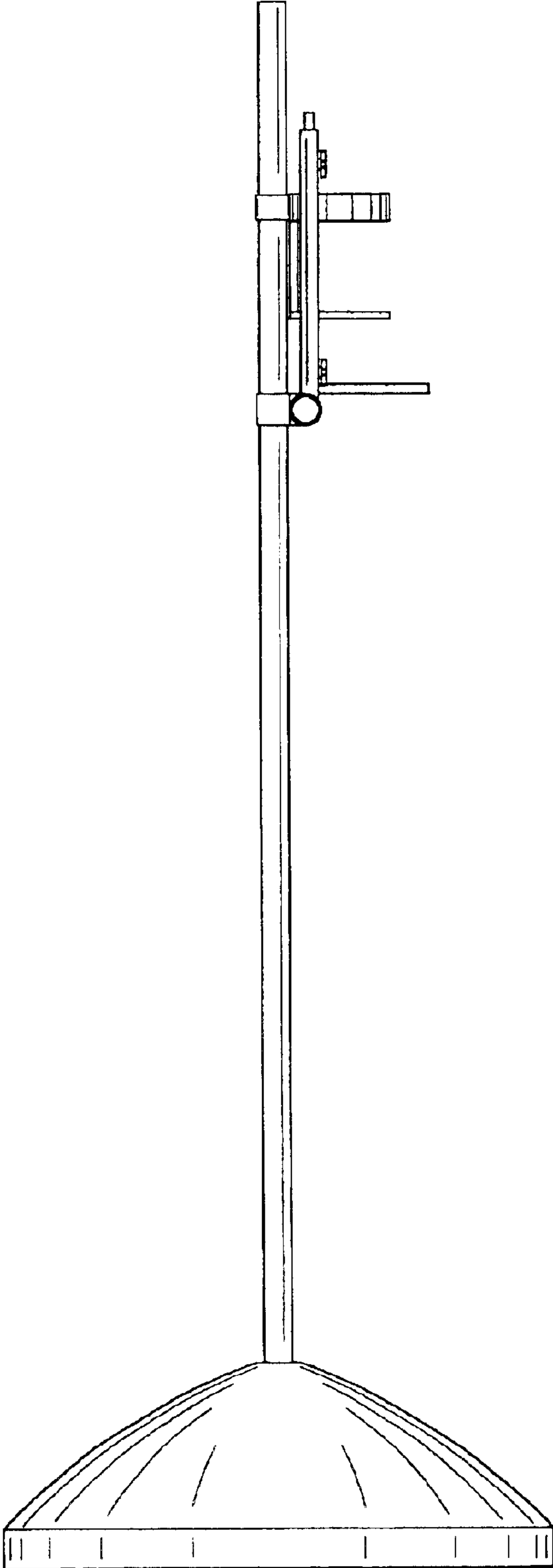

FIG. 3

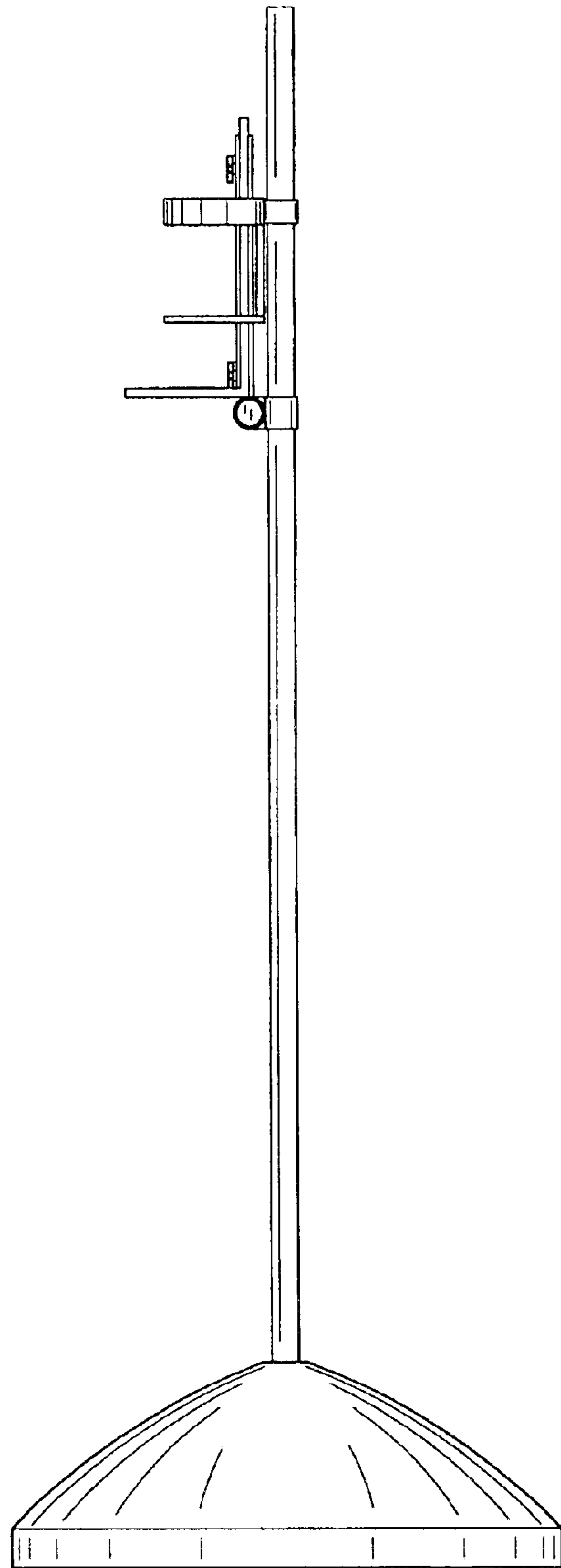

FIG. 4

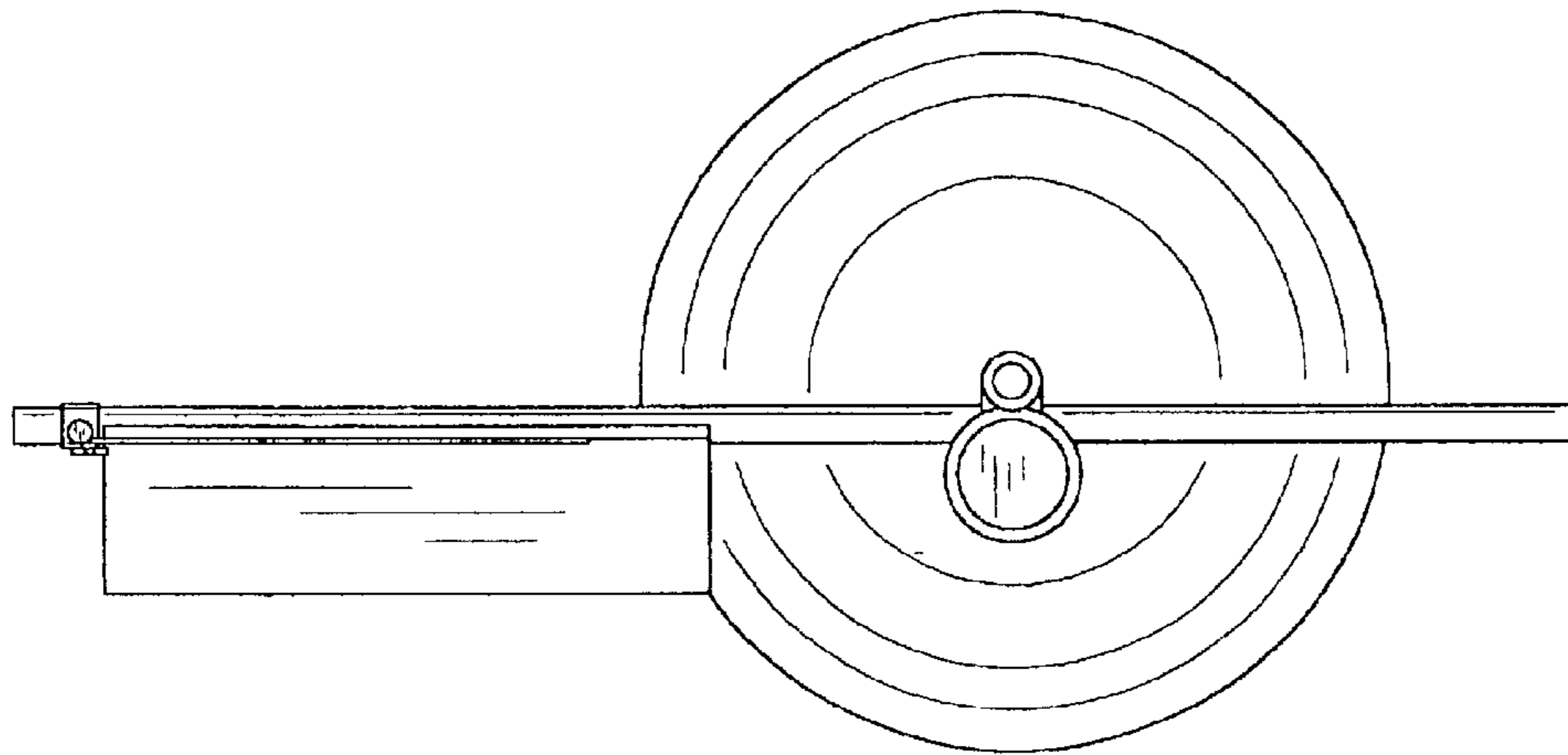

FIG. 5

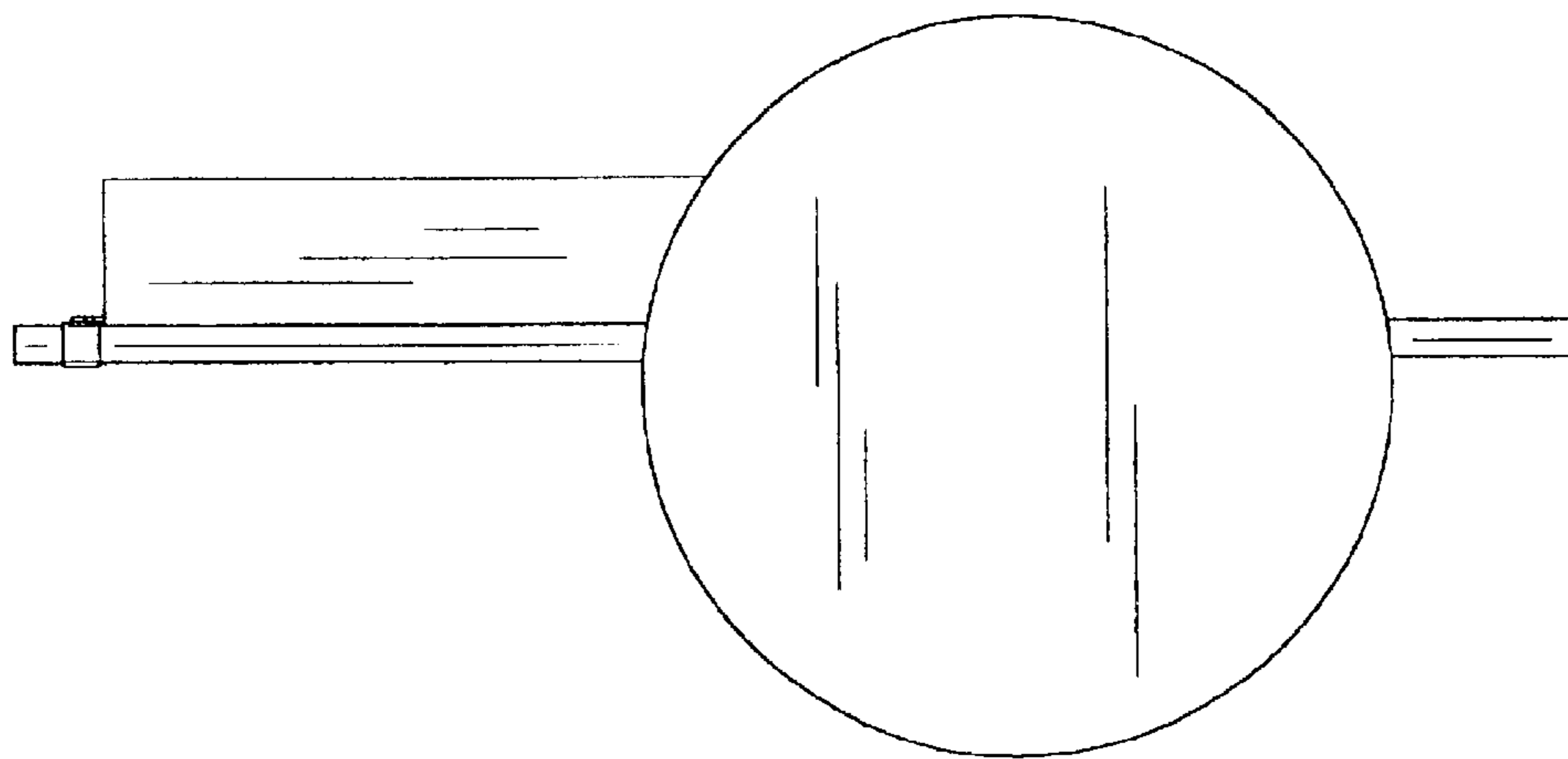

FIG. 6