

US00D499889S

(12) **United States Design Patent**
Hahn

(10) **Patent No.:** **US D499,889 S**
(45) **Date of Patent:** **** Dec. 21, 2004**

(54) **APPARATUS FOR FRAMING AND HANGING A SHEET-LIKE DISPLAY ITEM**

6,298,591 B1 10/2001 Healy
6,305,109 B1 10/2001 Lee
D487,354 S * 3/2004 Hahn D6/300

(76) Inventor: **Richard L. Hahn**, 1380 Lake Martin Dr., Kent, OH (US) 44240

* cited by examiner

(**) Term: **14 Years**

Primary Examiner—Janice E. Seeger

(21) Appl. No.: **29/191,093**

(57) **CLAIM**

(22) Filed: **Oct. 2, 2003**

The ornamental design for an apparatus for framing and hanging a sheet-like display item, as shown and described.

Related U.S. Application Data

DESCRIPTION

(62) Division of application No. 29/168,011, filed on Sep. 25, 2002, now Pat. No. Des. 487,354.

This apparatus for framing and hanging a sheet-like display item is characterized by two generally identical elongate members having decorative ornaments on the front.

(51) **LOC (7) Cl.** **06-07**

FIG. 1 is a perspective view of an apparatus for framing and hanging a sheet-like display item, showing my new design; FIG. 2 is a front elevational view of the top portion of the apparatus, the bottom portion being a mirror image;

(52) **U.S. Cl.** **D6/300**

(58) **Field of Search** D6/300-303, 309-314; 40/700, 711, 722, 724, 732, 745, 747, 749, 756, 780, 790, 798, 757; 211/45, 89.01

FIG. 3 is a top plan view of the top portion of the apparatus, the bottom portion being a mirror image;

(56) **References Cited**

FIG. 4 is a left side elevational view of the apparatus, the right side being a mirror image;

U.S. PATENT DOCUMENTS

1,738,273 A	12/1929	Anderson
2,280,907 A	4/1942	Fink
3,298,374 A	1/1967	Grundell
3,665,628 A	5/1972	Dammond
3,914,892 A	10/1975	Mohr
4,105,127 A	8/1978	Holl
D250,504 S	12/1978	Kliot
4,187,630 A	2/1980	Giulie et al.
4,277,903 A	7/1981	Crossot
D266,380 S	10/1982	Ploeger
4,356,647 A	11/1982	Farris
D268,242 S	3/1983	Fitchett
4,459,773 A	7/1984	Sandlin et al.
D300,285 S	3/1989	Karklins

FIG. 5 is a perspective view of an apparatus for framing and hanging a sheet-like display item, showing an alternative embodiment of my new design;

FIG. 6 is a front elevational view of the top portion of the apparatus, the bottom portion being a mirror image;

FIG. 7 is a top plan view of the top portion of the apparatus, the bottom portion being a mirror image; and,

FIG. 8 is a left side elevational view of the apparatus, the right side being a mirror image.

The rear views are omitted and form no part of the claimed design. The dashed lines are shown for environmental purposes only and form no part of the claimed design.

1 Claim, 4 Drawing Sheets

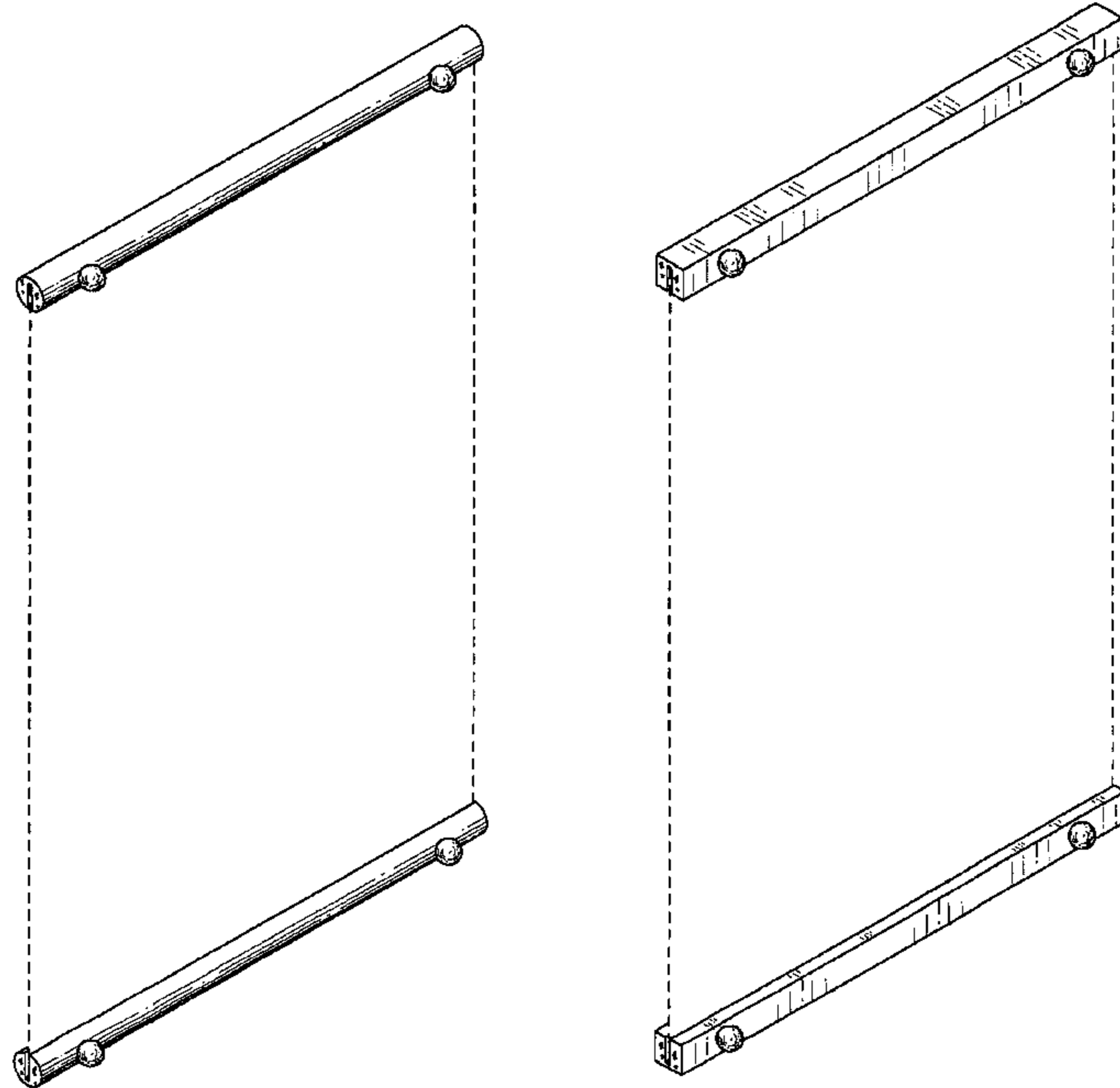

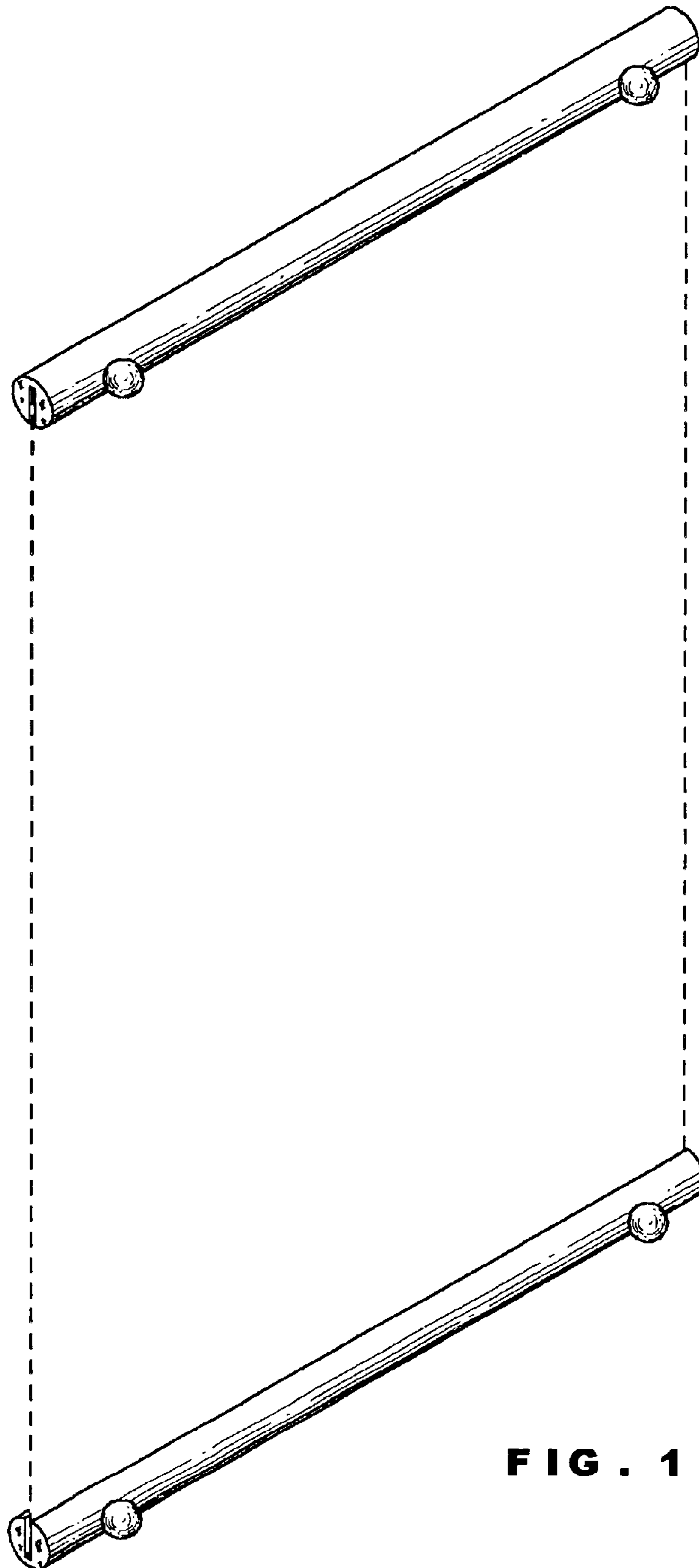

FIG . 1

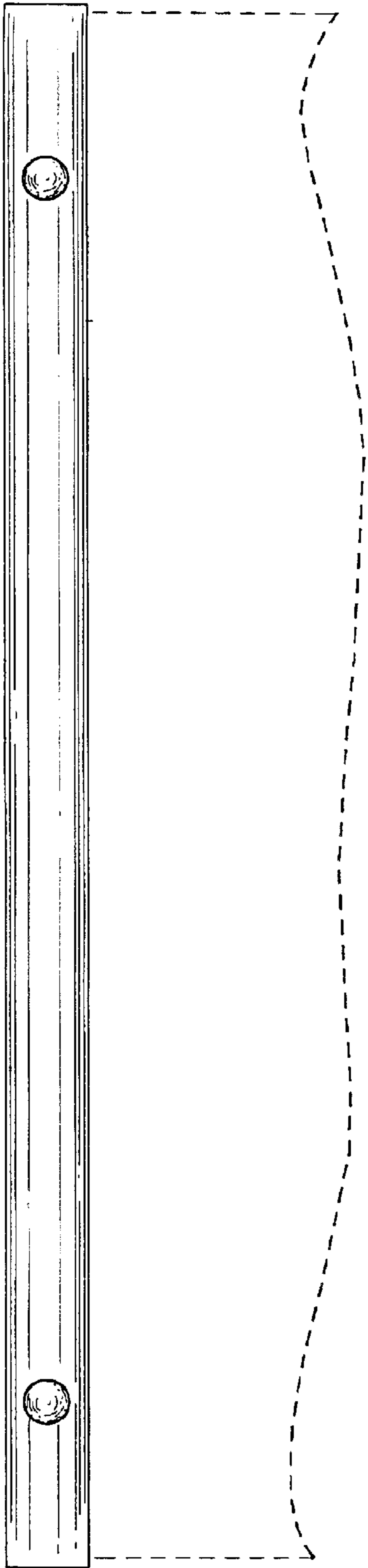

FIG. 2

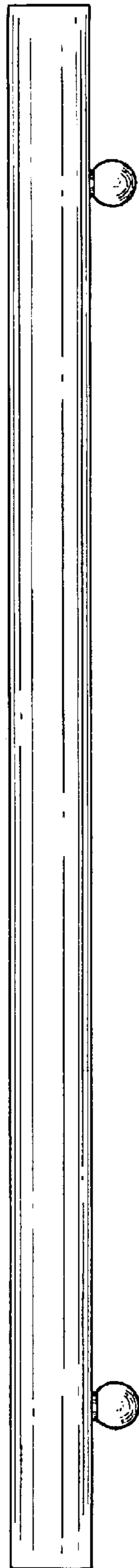

FIG. 3

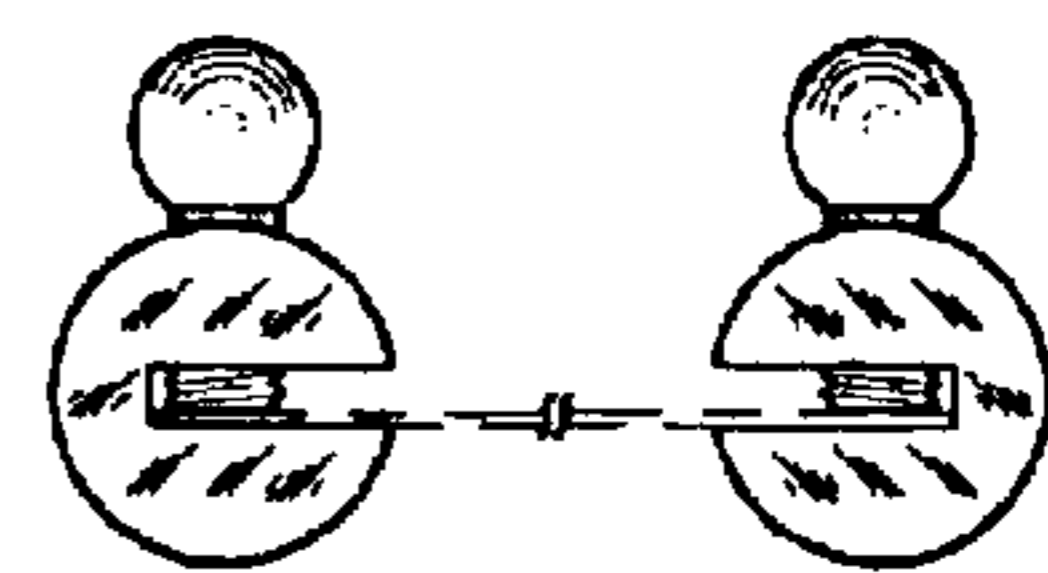

FIG. 4

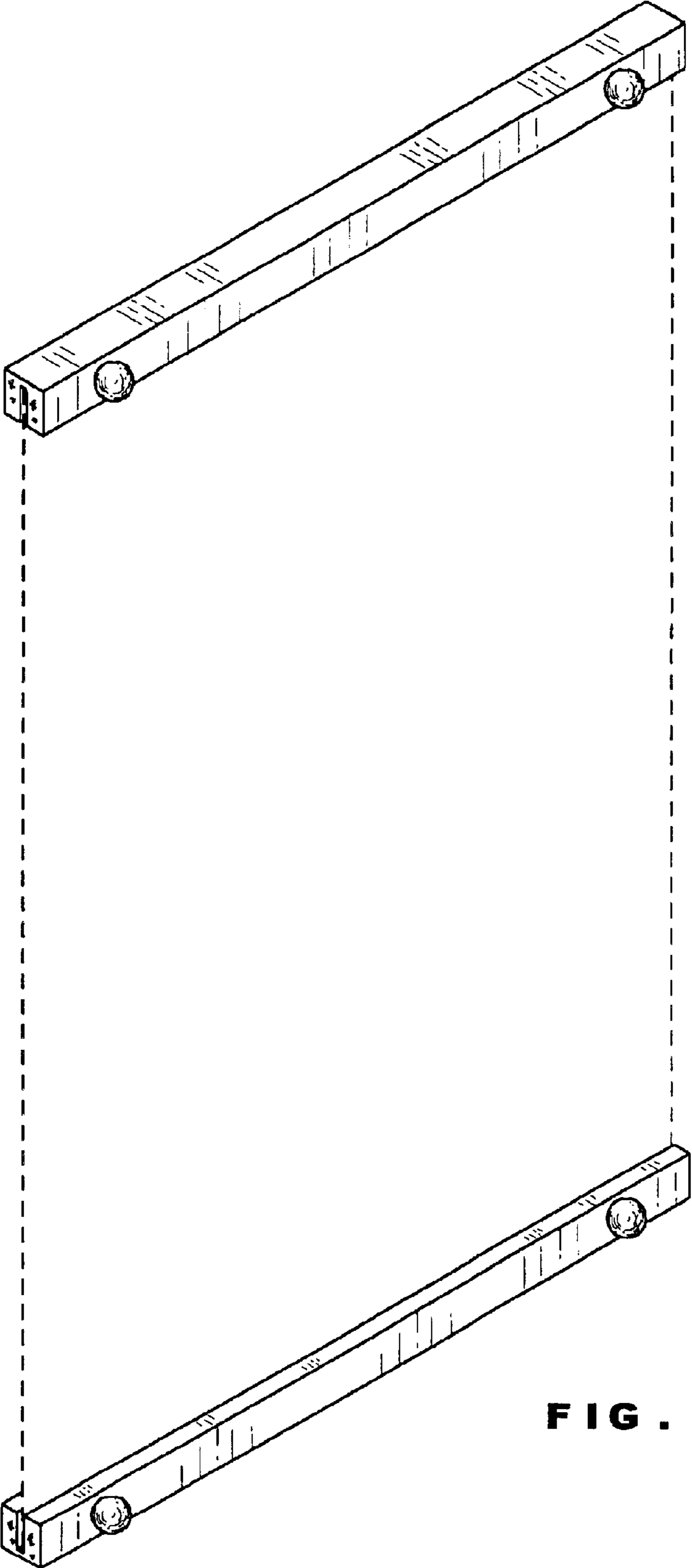

FIG . 5

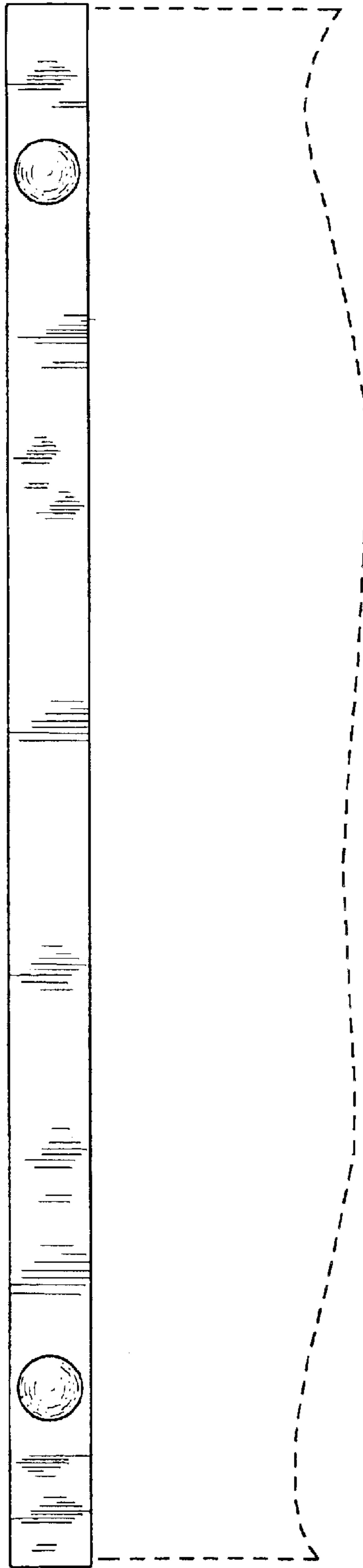

FIG. 6

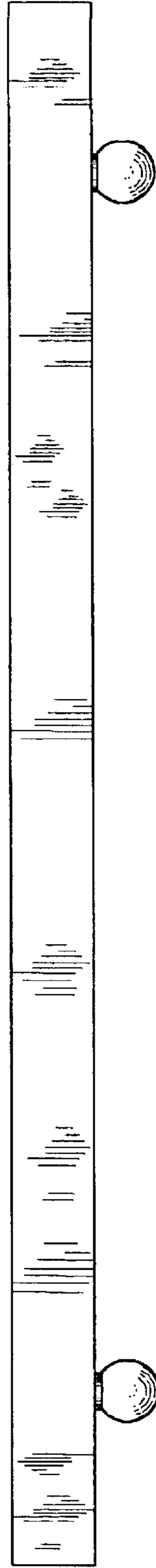

FIG. 7

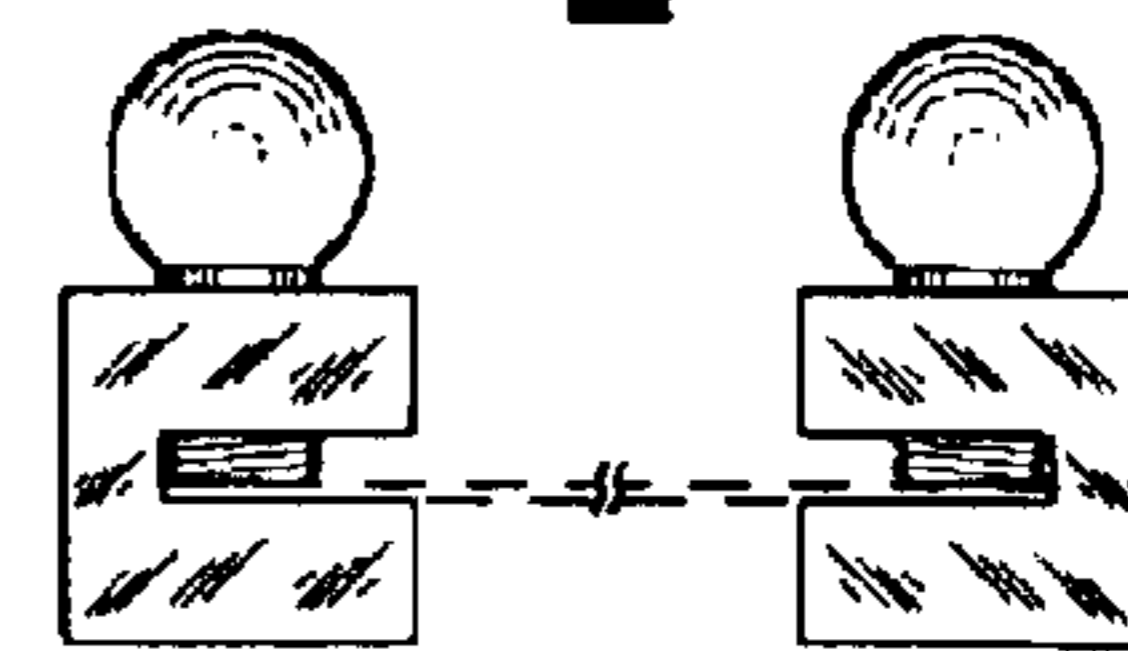

FIG. 8