

US00D499591S

(12) **United States Design Patent**
Hernandez et al.

(10) **Patent No.: US D499,591 S**

(45) **Date of Patent: ** Dec. 14, 2004**

(54) **TOOTHBRUSH AND CUP HOLDER**

(75) Inventors: **Roland Hernandez**, Chicago, IL (US);
Michael Jaron, Chicago, IL (US)

(73) Assignee: **Home Products International, Inc.**,
Chicago, IL (US)

(**) Term: **14 Years**

(21) Appl. No.: **29/201,815**

(22) Filed: **Mar. 22, 2004**

(51) **LOC (7) Cl.** **23-02**

(52) **U.S. Cl.** **D6/531**

(58) **Field of Search** D6/528-540, 524;
248/309.1; 206/77.1, 362.1, 362.2; 211/13.1,
86.01, 88.01, 126.1, 134

(56) **References Cited**

U.S. PATENT DOCUMENTS

D357,151 S * 4/1995 Santapa D6/531
5,638,840 A * 6/1997 Lee et al. D6/531
D405,996 S * 2/1999 Mickler et al. D6/530

D463,933 S * 10/2002 Carlson et al. D6/531
6,457,592 B1 * 10/2002 Rozen 211/65
D481,571 S * 11/2003 Henderson et al. D6/531
D482,556 S * 11/2003 Huang D6/534

* cited by examiner

Primary Examiner—Brian N Vinson

(74) *Attorney, Agent, or Firm*—Wood, Phillips, Katz, Clark
& Mortimer

(57) **CLAIM**

The ornamental design for a toothbrush and cup holder,
substantially as shown and described.

DESCRIPTION

FIG. 1 is a perspective view of a toothbrush and cup holder
showing our new design;
FIG. 2 is a front elevational view thereof;
FIG. 3 is a rear elevational view thereof;
FIG. 4 is a left side elevational view thereof;
FIG. 5 is a right side elevational view thereof;
FIG. 6 is a top plan view thereof; and,
FIG. 7 is a bottom plan view thereof.

1 Claim, 4 Drawing Sheets

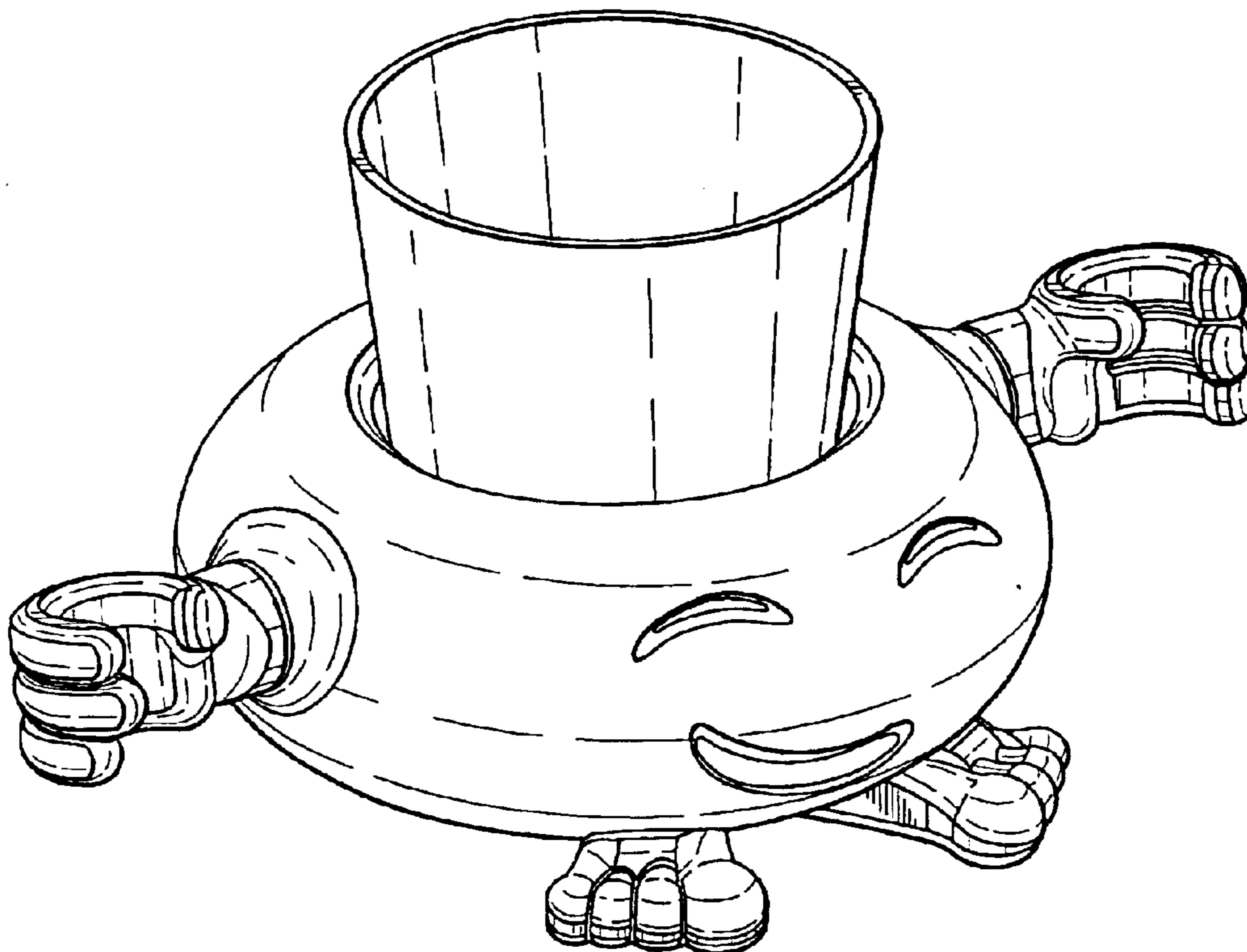

Fig. 1

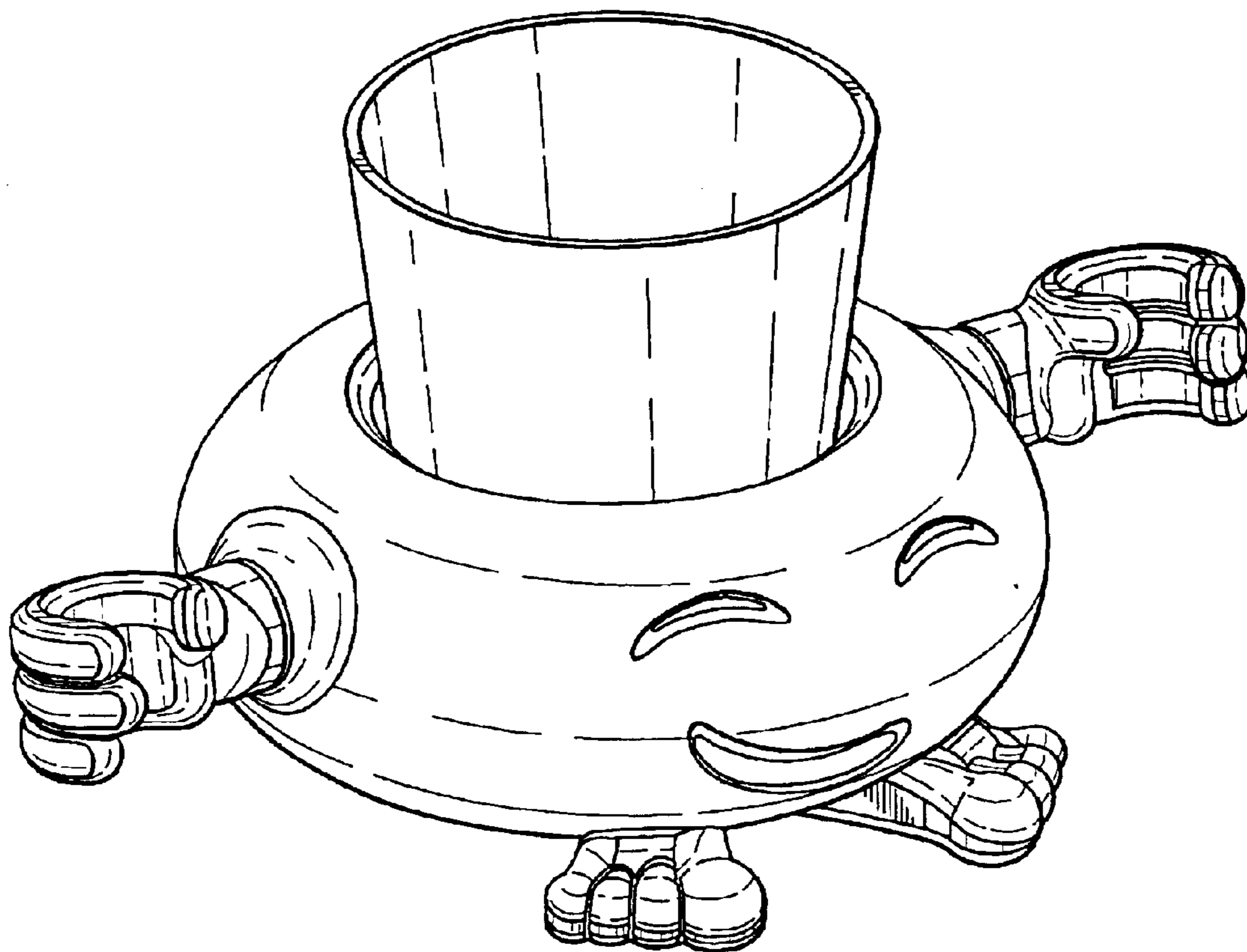

Fig. 2

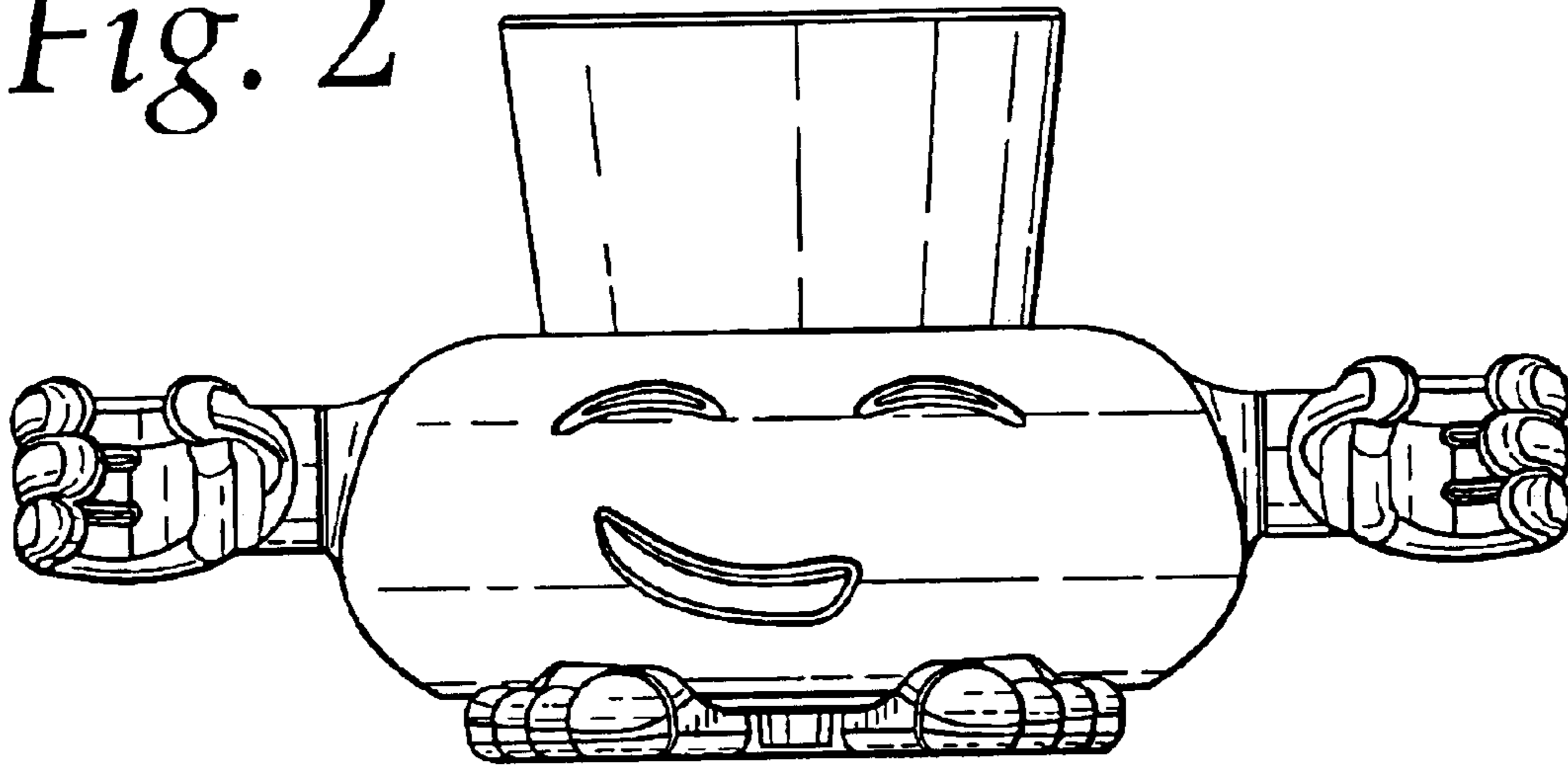

Fig. 3

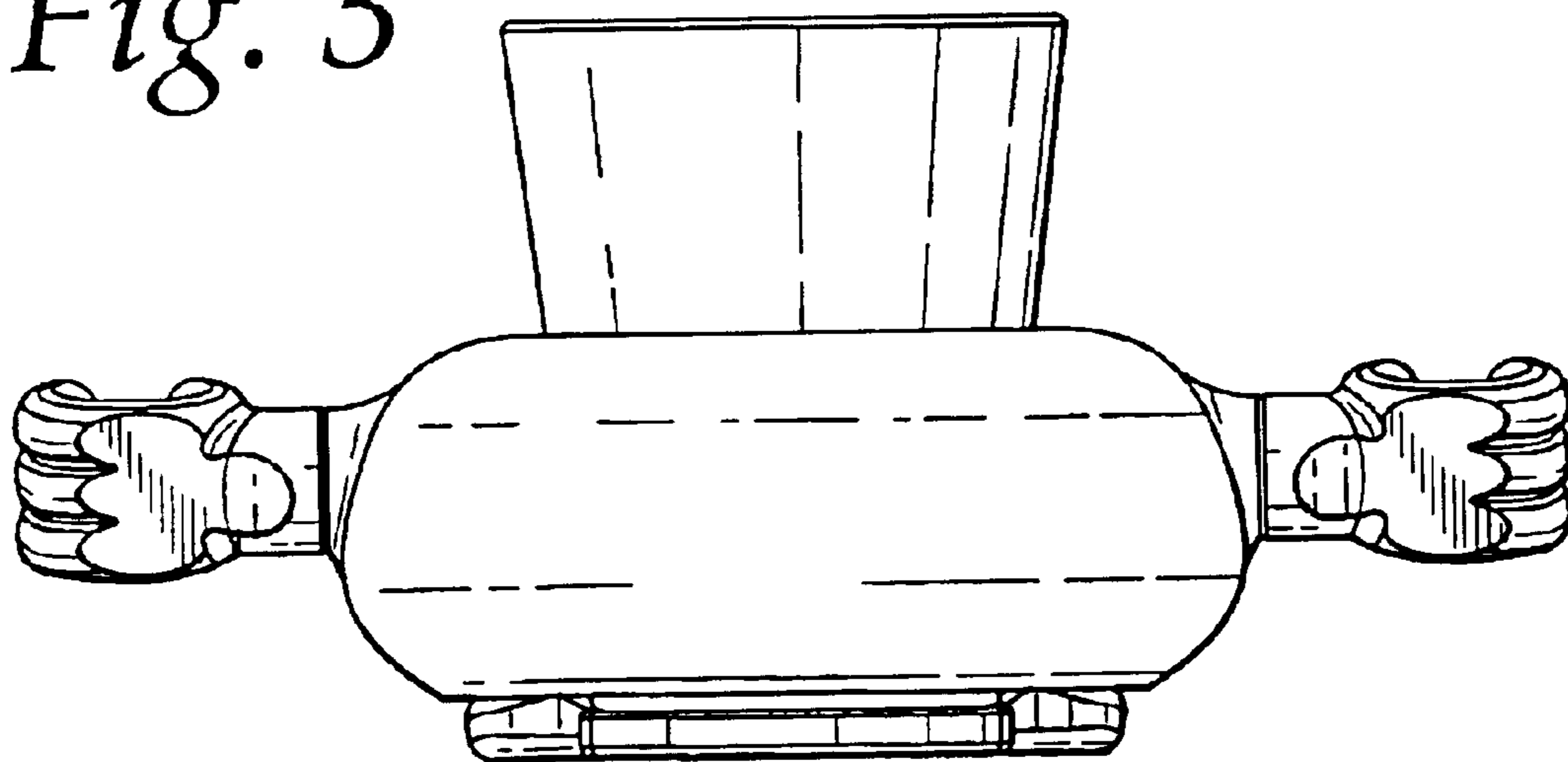

Fig. 4

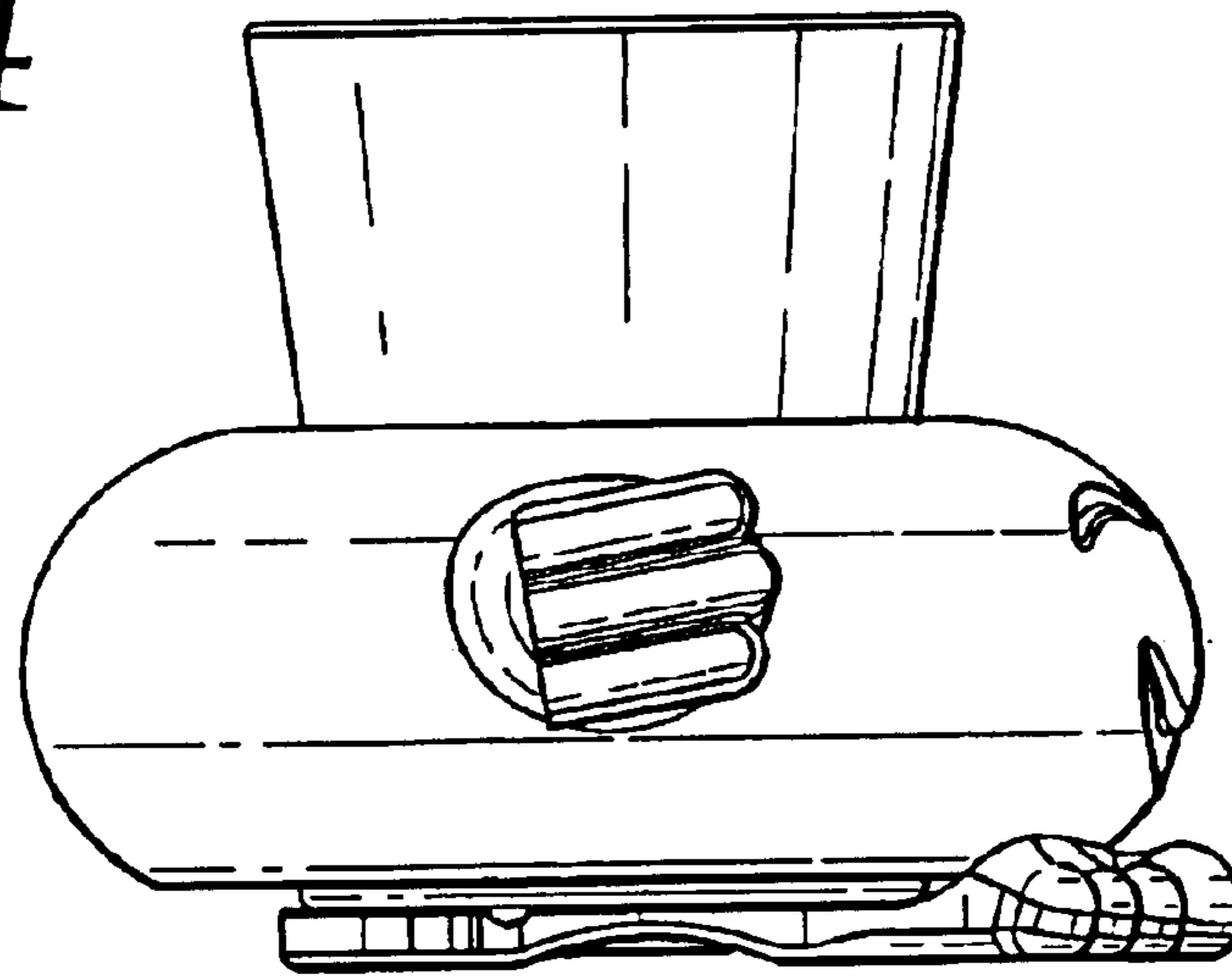

Fig. 5

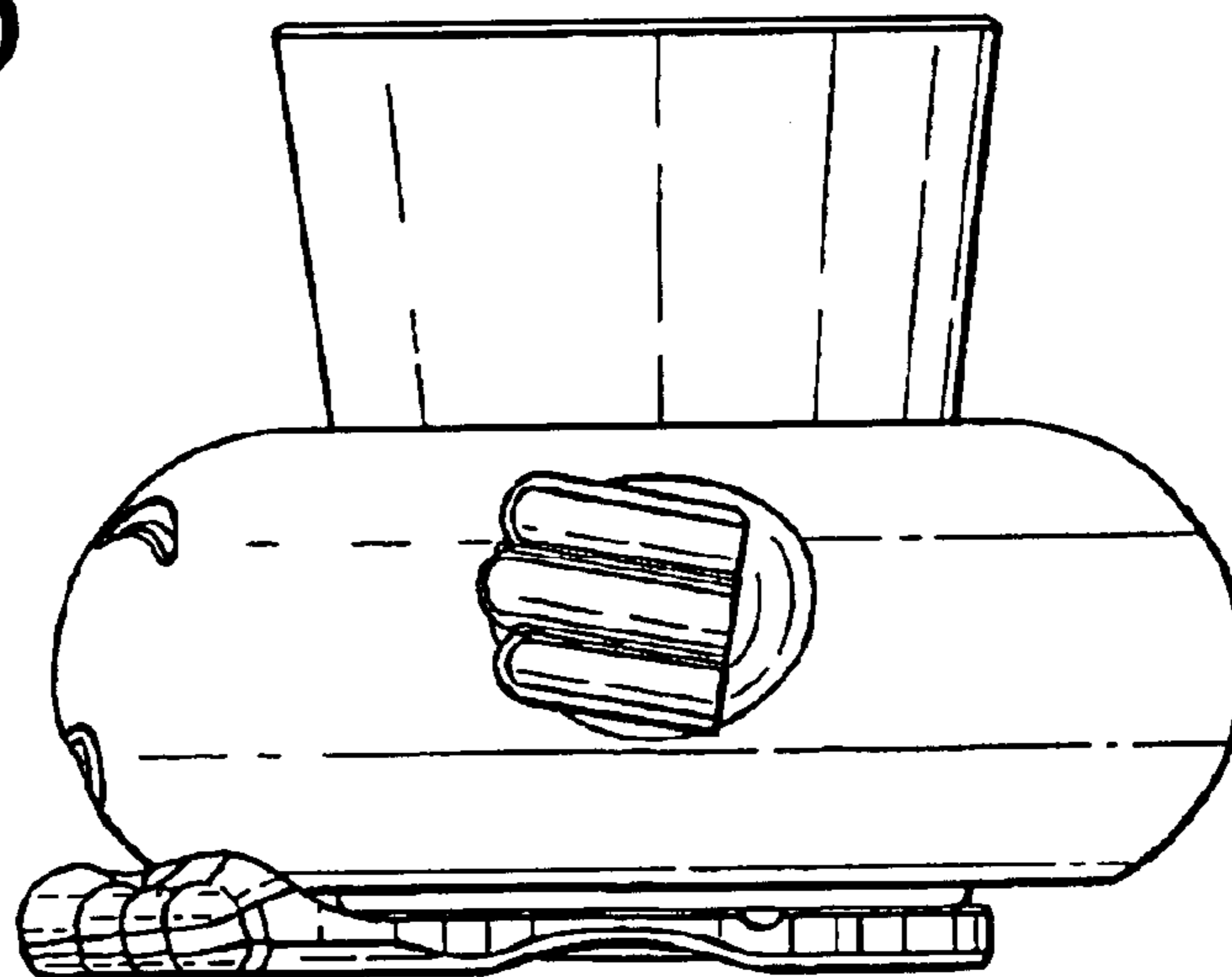

Fig. 6

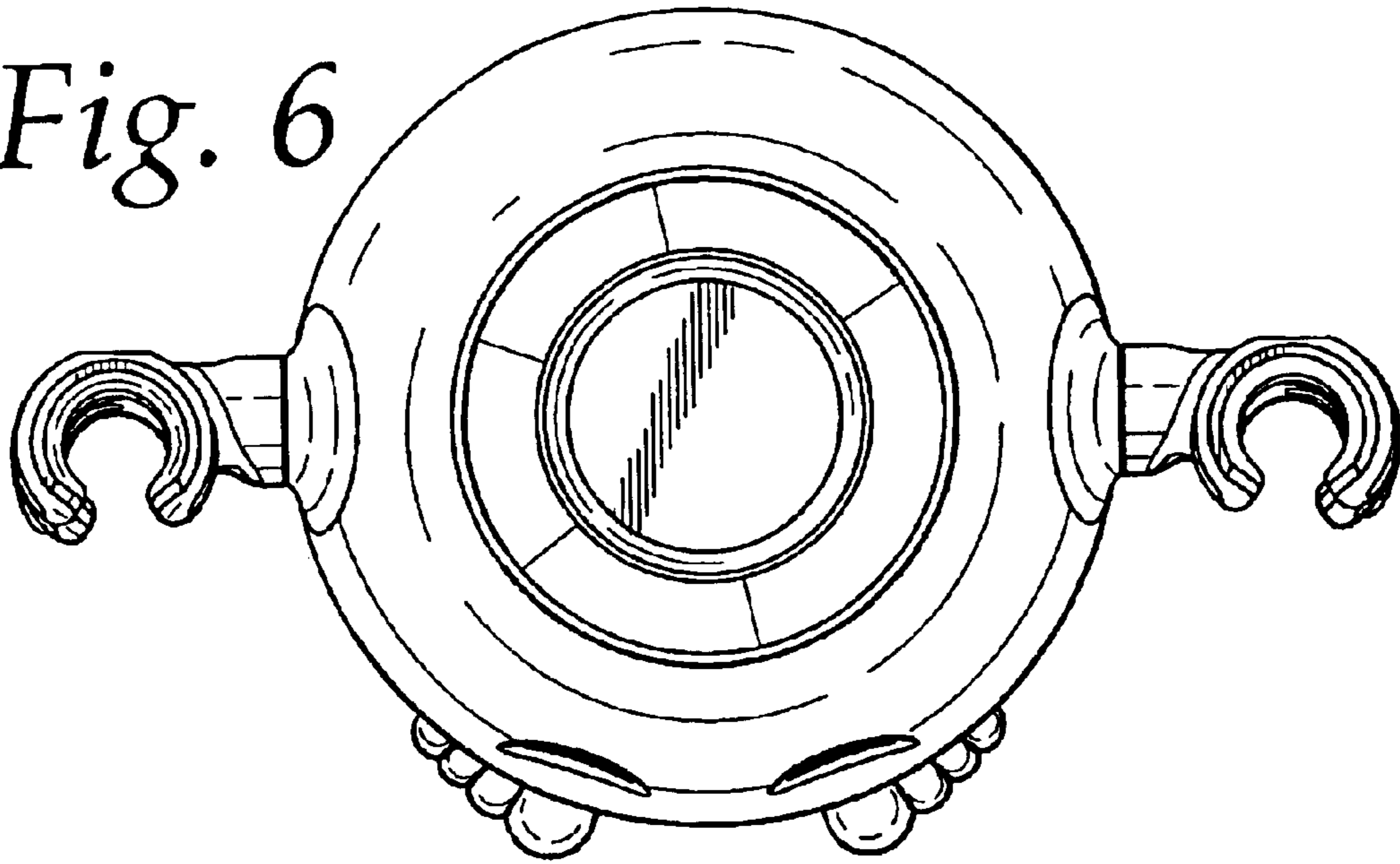

Fig. 7

