



US00D499508S

(12) **United States Design Patent** (10) **Patent No.:** **US D499,508 S**  
**Park** (45) **Date of Patent:** **\*\* Dec. 7, 2004**

(54) **LIGHTER**

(75) Inventor: **Keith K. Park**, La Canada Flintridge, CA (US)

(73) Assignee: **Prometheus International, Inc.**, Commerce, CA (US)

(\*\*) Term: **14 Years**

(21) Appl. No.: **29/201,616**

(22) Filed: **Mar. 18, 2004**

(51) **LOC (7) Cl.** ..... **27-05**

(52) **U.S. Cl.** ..... **D27/143; D27/157**

(58) **Field of Search** ..... **D27/141-143, D27/154-161; 431/151, 153, 253-256, 274-277; 131/249**

(56) **References Cited**

**U.S. PATENT DOCUMENTS**

D459,834 S	*	7/2002	Park	.....	D27/143
D460,211 S	*	7/2002	Park	.....	D27/143
D475,803 S	*	6/2003	Park	.....	D27/143
D484,640 S	*	12/2003	Park	.....	D27/157
D492,061 S	*	6/2004	Reynolds	.....	D27/143

**OTHER PUBLICATIONS**

Prometheus Fall 2002—Fall 2003 catalog, Prometheus International, Inc., pp. 54, 55, 70 (Oct. 2002).  
Prometheus New Products for Fall 2002—Fall 2003, Prometheus International, Inc., p. 3 (Oct. 2002).  
Prometheus Fall 2003—Fall 2004 catalog, Prometheus International, Inc., pp. 57, 60-62, 70 (Oct. 2003).

\* cited by examiner

*Primary Examiner*—Jennifer Rivard  
(74) *Attorney, Agent, or Firm*—Knobbe, Martens, Olson & Bear, LLP

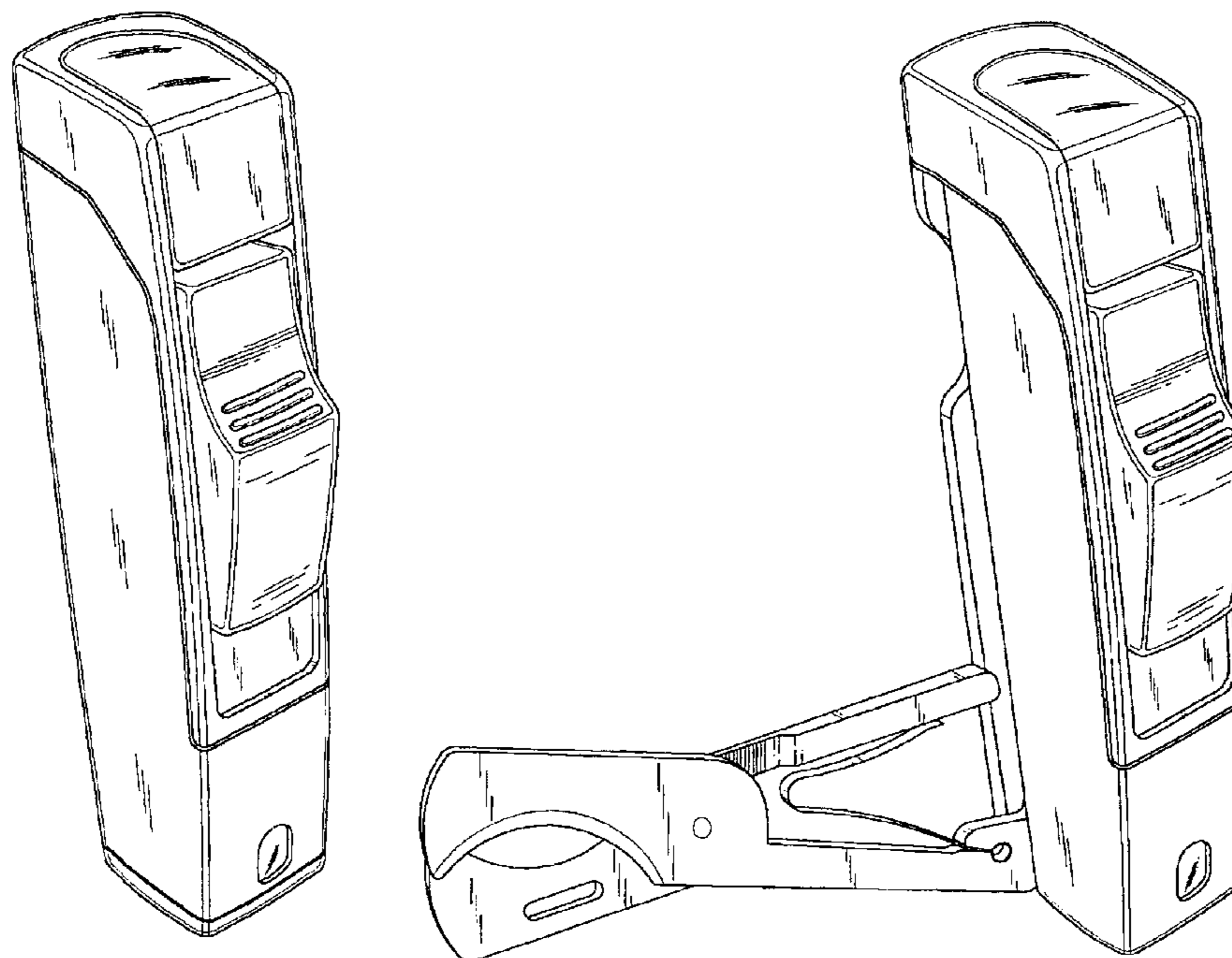
(57) **CLAIM**

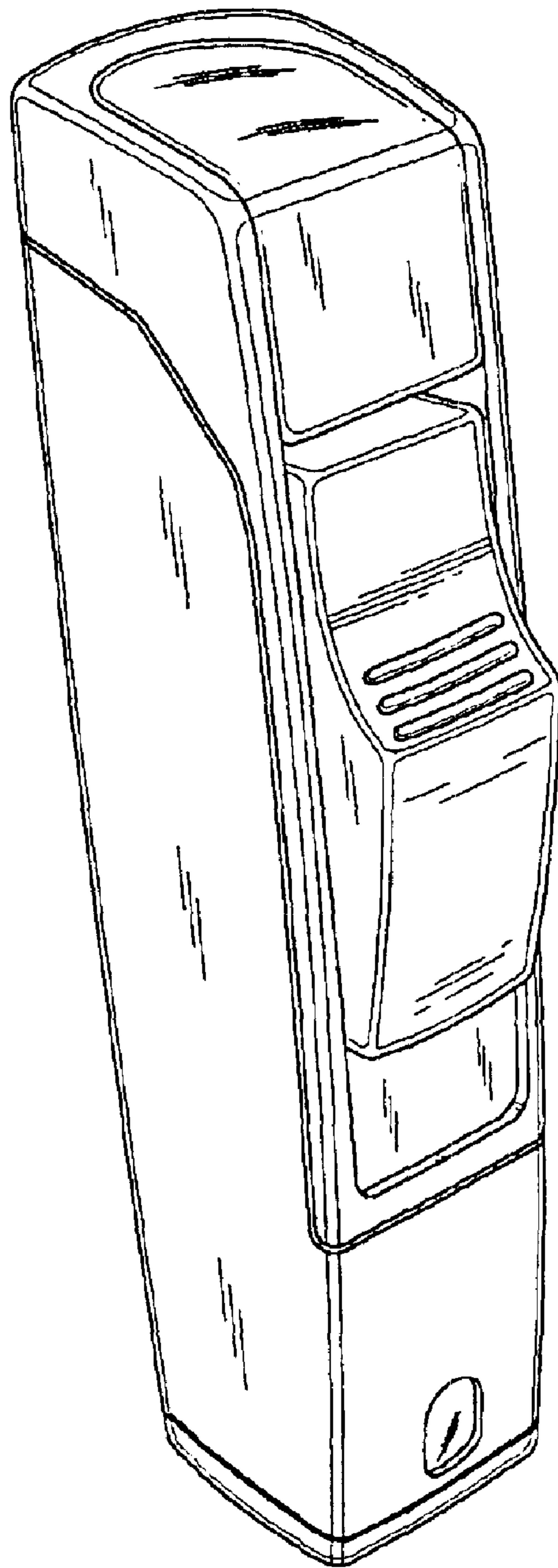
The ornamental design for a lighter, as shown and described.

**DESCRIPTION**

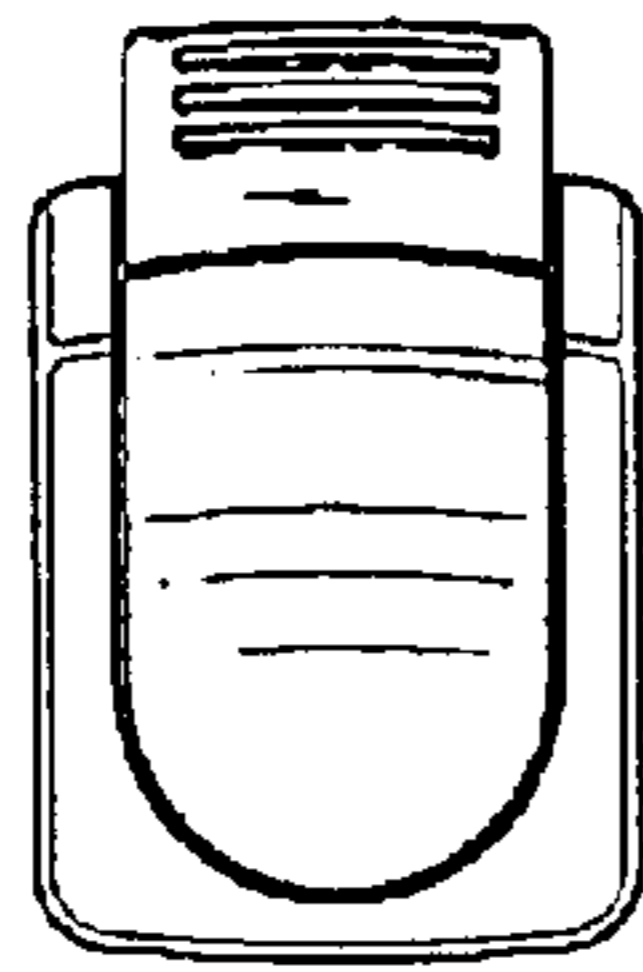
FIG. 1 is a front perspective view of a preferred embodiment of the lighter according to the present design; FIG. 2 is a top plan view of the lighter of FIG. 1; FIG. 3 is a bottom plan view of the lighter of FIG. 1; FIG. 4 is a front elevational view of the lighter of FIG. 1; FIG. 5 is a rear elevational view of the lighter of FIG. 1; FIG. 6 is a right-side elevational view of the lighter of FIG. 1, the left-side elevational view being a mirror image thereof; FIG. 7 is a front perspective view of another preferred embodiment of the lighter according to the present design; FIG. 8 is a front perspective view of the lighter of FIG. 7, illustrating a scissors of the lighter in an unfolded configuration; FIG. 9 is a top plan view of the lighter of FIG. 7; FIG. 10 is a bottom plan view of the lighter of FIG. 7; FIG. 11 is a front elevational view of the lighter of FIG. 7; FIG. 12 is a rear elevational view of the lighter of FIG. 7; FIG. 13 is a right-side elevational view of the lighter of FIG. 7; and, FIG. 14 is a left-side elevational view of the lighter of FIG. 7.  
Phantom lining, where used, is for illustrative purposes only and is not intended to limit the claimed design to the features shown in phantom.

**1 Claim, 5 Drawing Sheets**

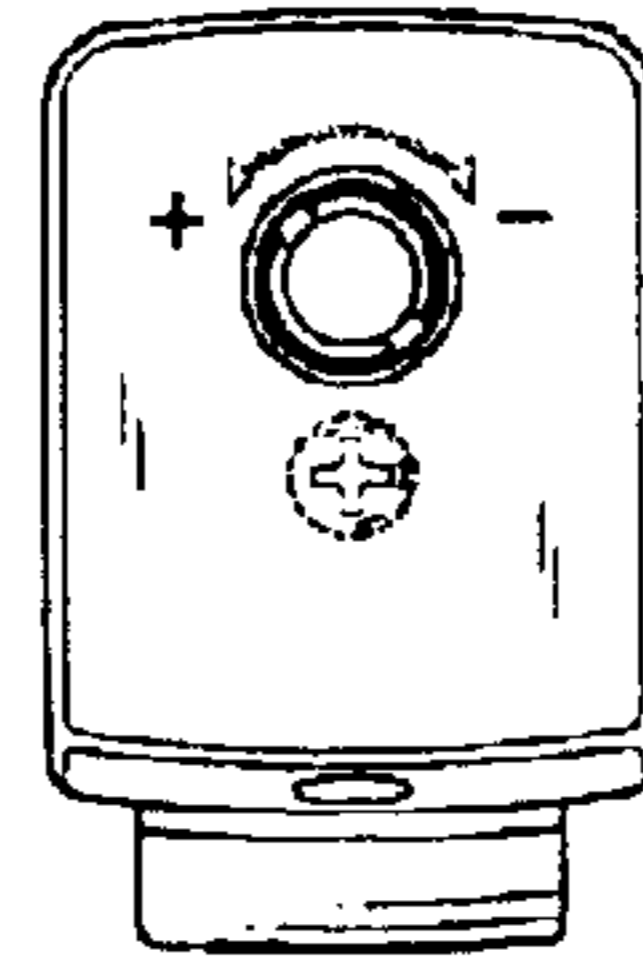




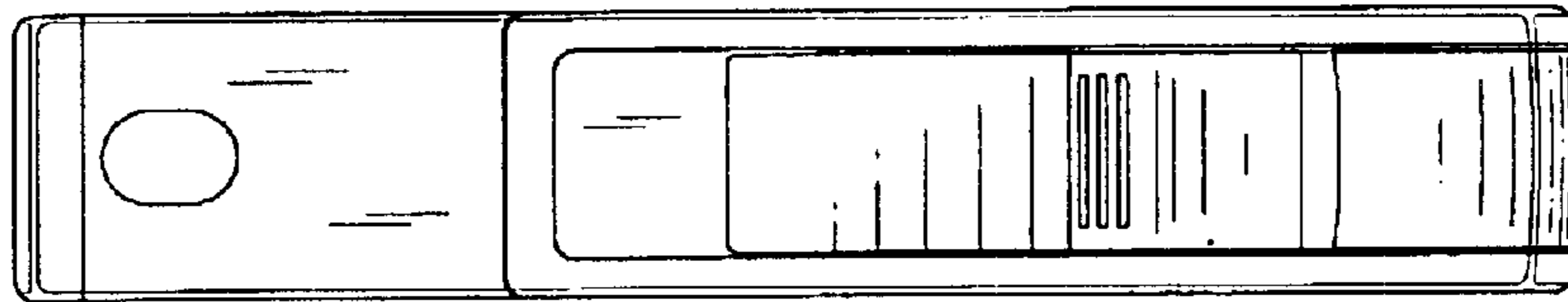
*FIG. 1*



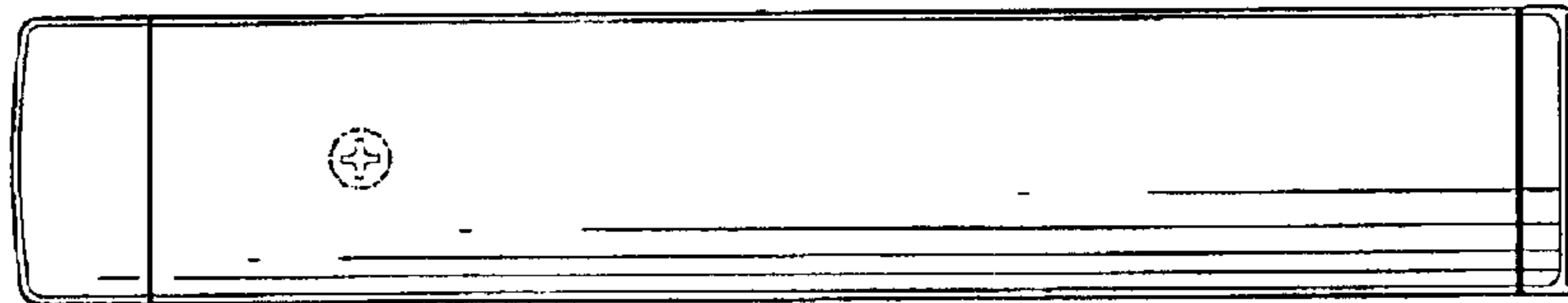
*FIG. 2*



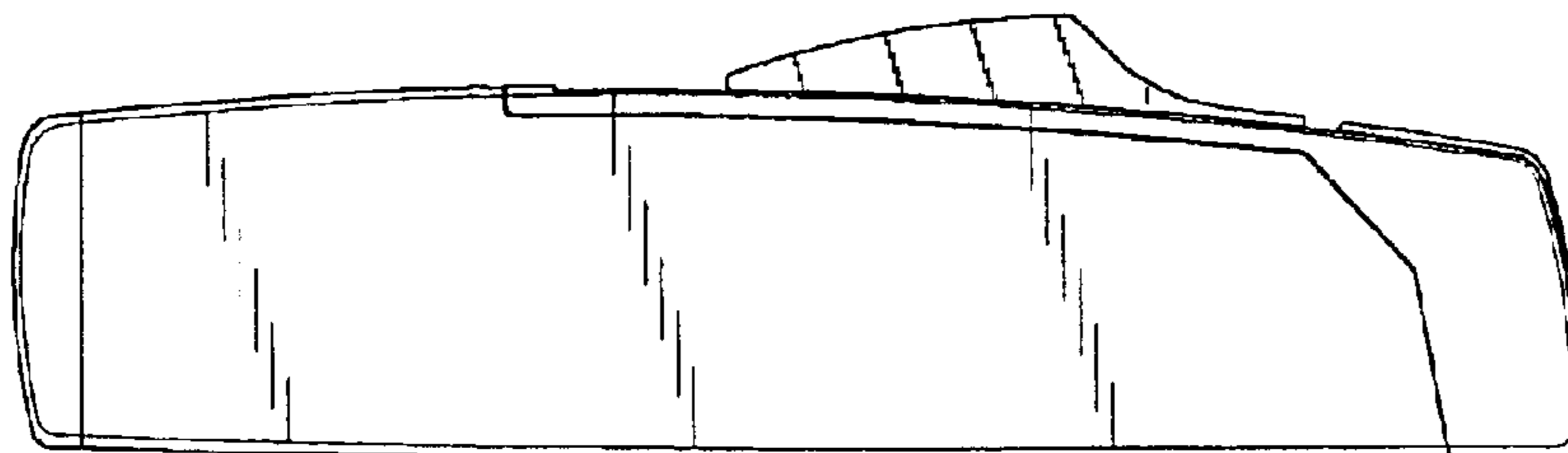
*FIG. 3*



*FIG. 4*



*FIG. 5*



*FIG. 6*

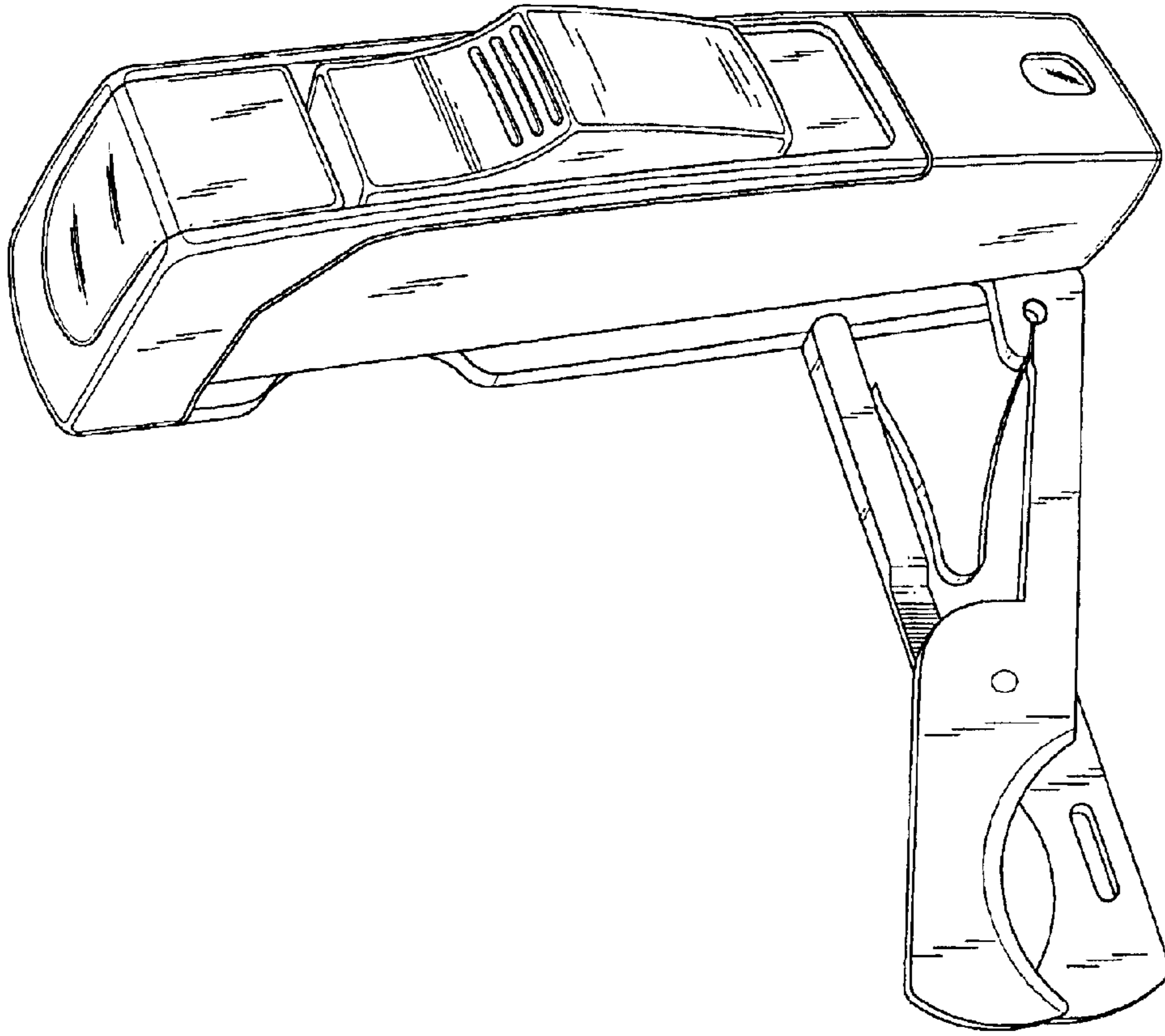


FIG. 8

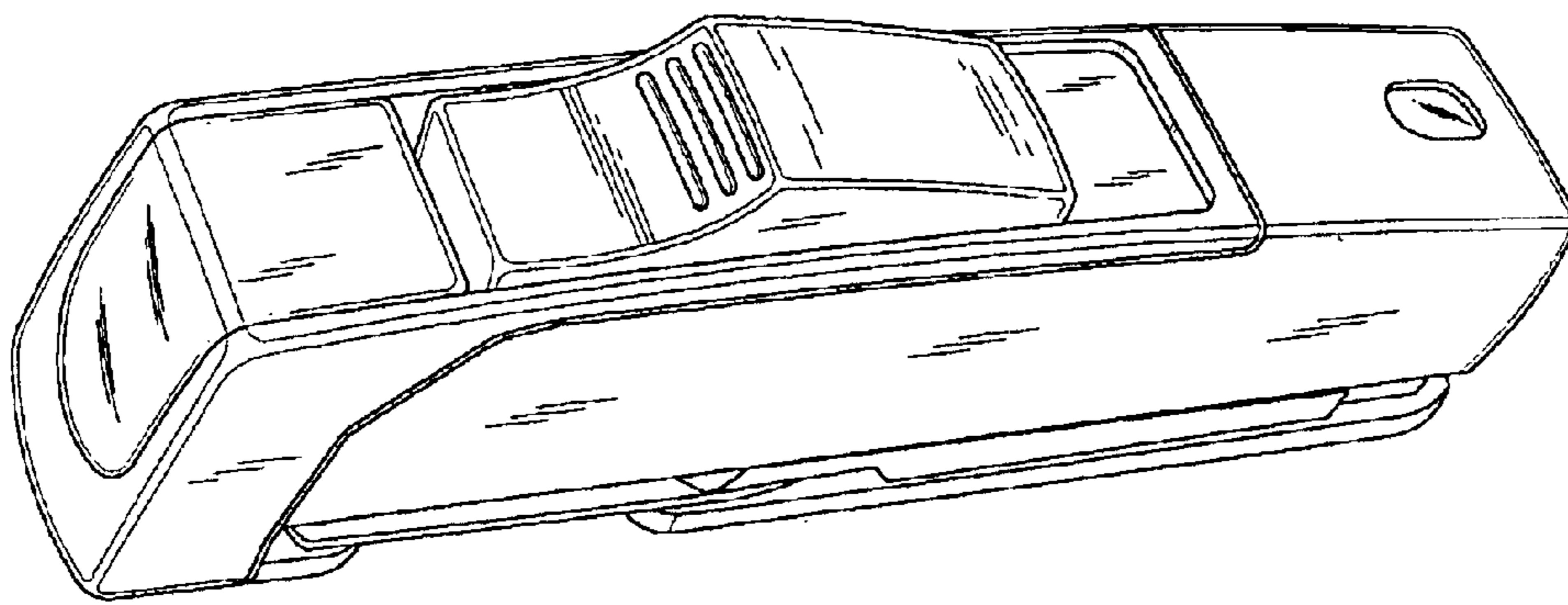
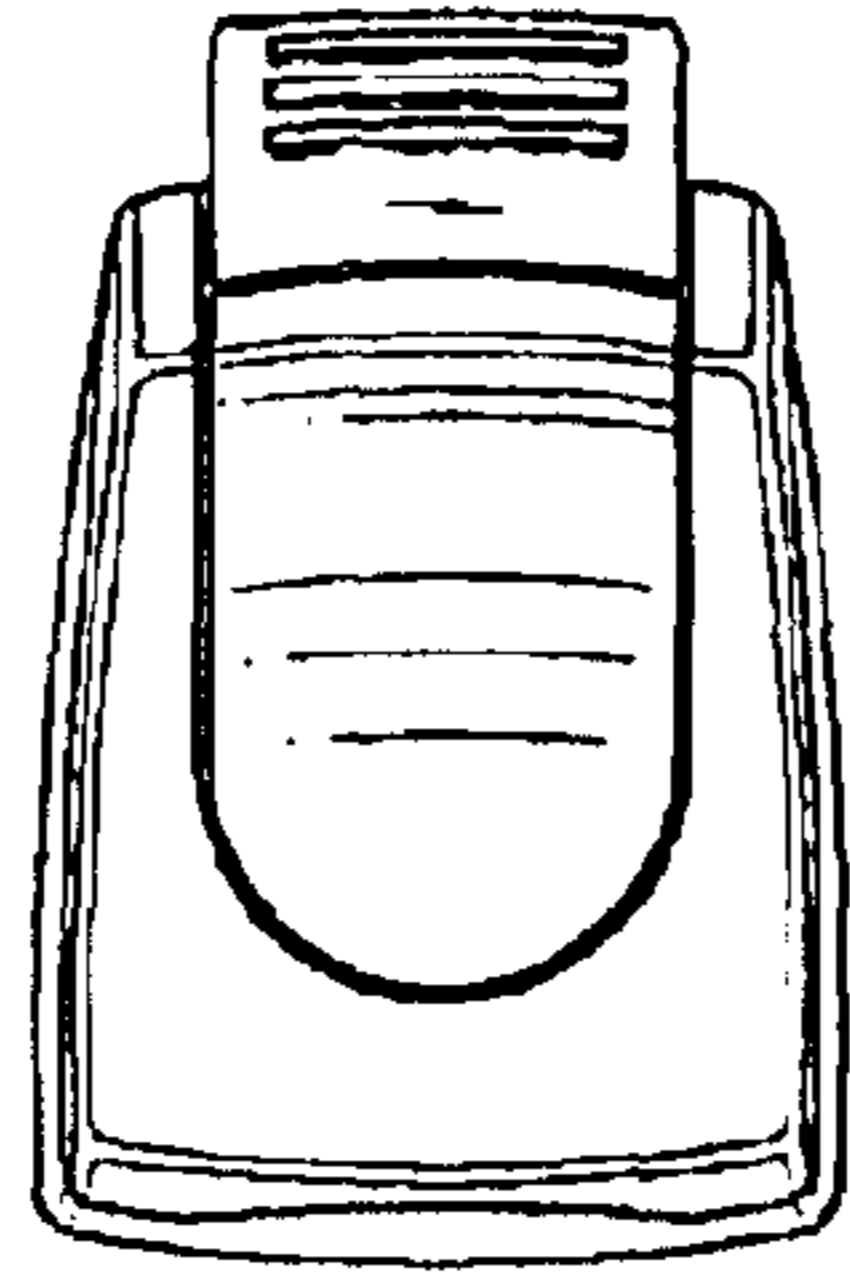
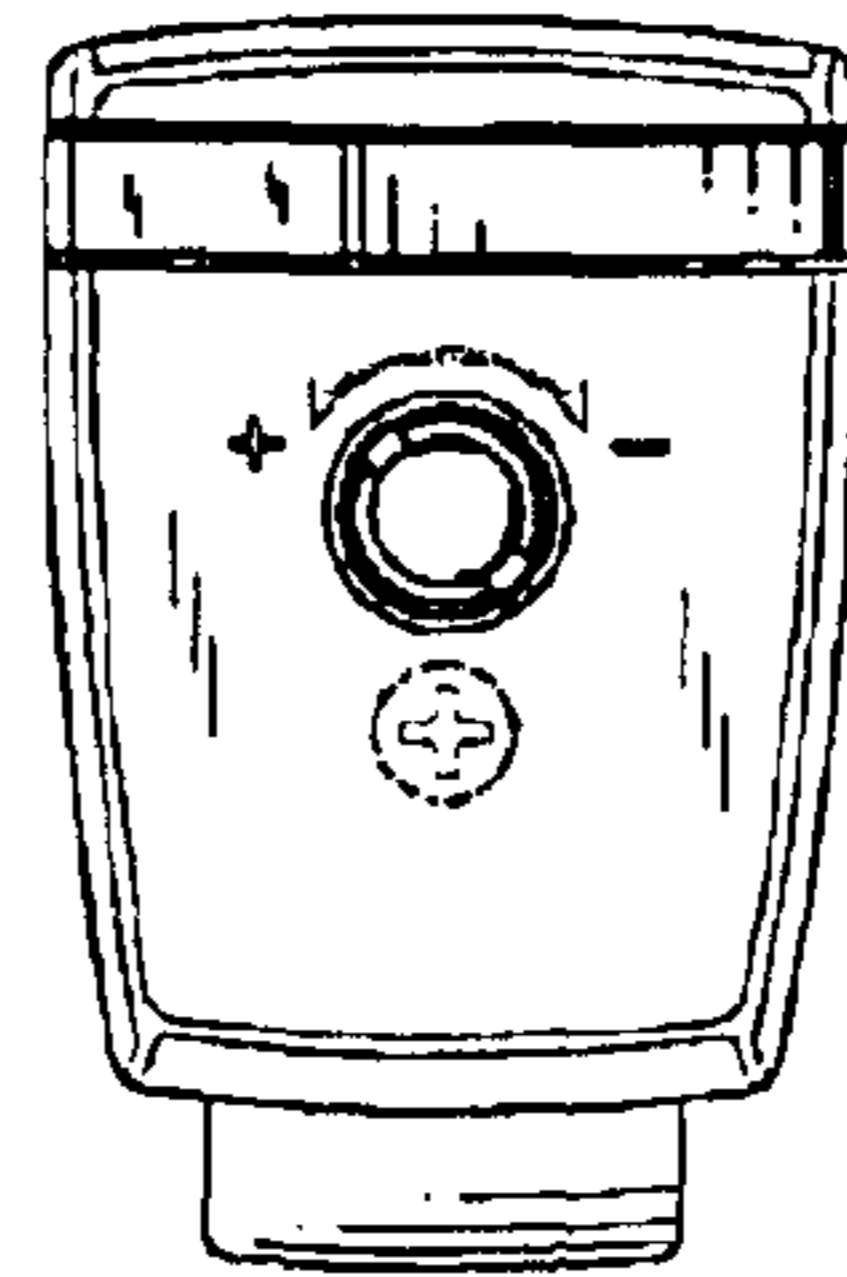


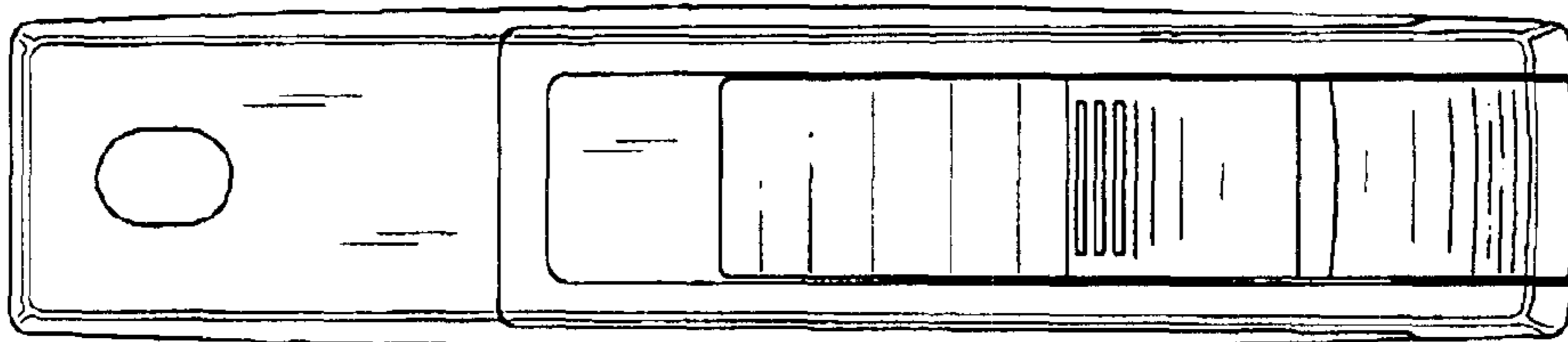
FIG. 7



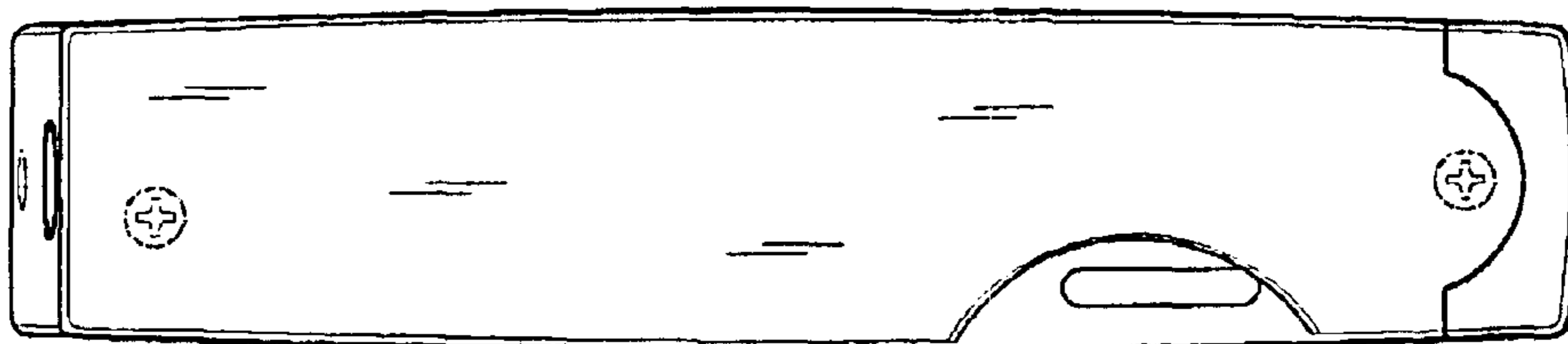
*FIG. 9*



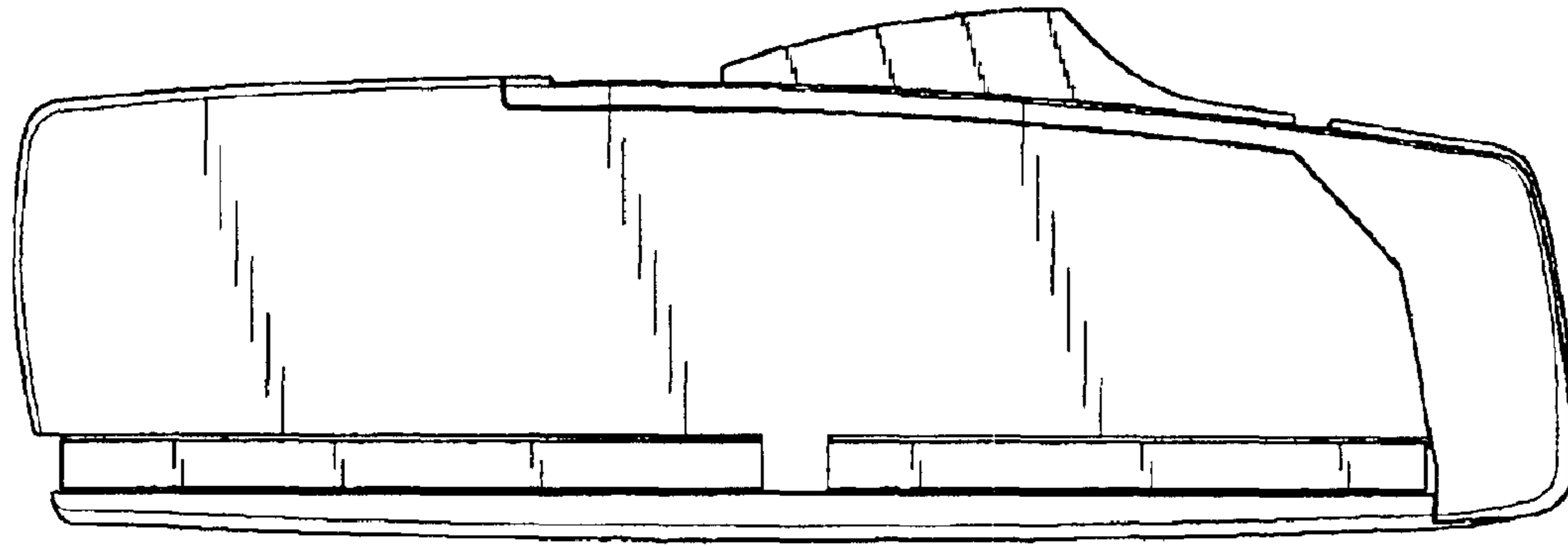
*FIG. 10*



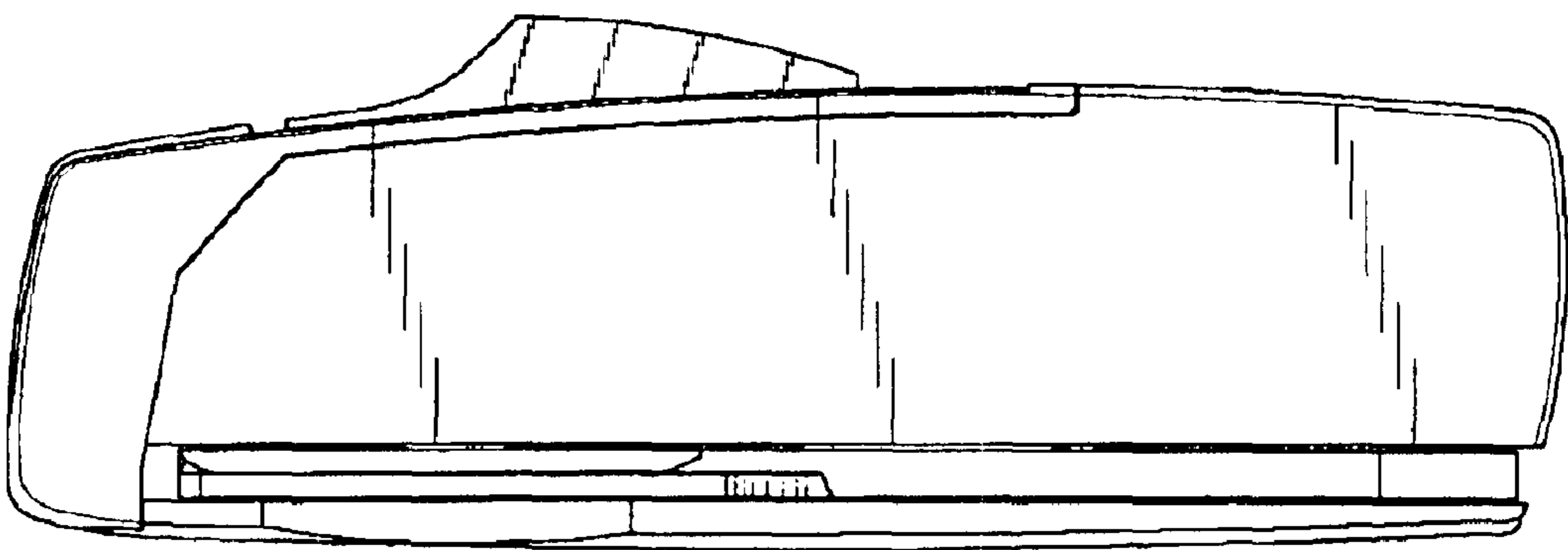
*FIG. 11*



*FIG. 12*



*FIG. 13*



*FIG. 14*