



US00D499500S

(12) **United States Design Patent**
Ciongoli

(10) **Patent No.:** **US D499,500 S**
(45) **Date of Patent:** **** Dec. 7, 2004**

(54) **COMBINATION FLASHLIGHT AND
KEYCHAIN HAVING A CRESCENT SHAPED
HALF MOON CONFIGURATION**

D448,158 S 9/2001 Zeller D3/209
D454,427 S 3/2002 Chan D3/209
D466,286 S 12/2002 Yuen D3/209

(76) **Inventor:** **Frank Ciongoli**, 821 Harvard Pl., Fort
Lee, NJ (US) 15515

* cited by examiner

(**) **Term:** **14 Years**

Primary Examiner—Marcus A. Jackson
(74) *Attorney, Agent, or Firm*—Goldstein Law Offices, P.C.

(21) **Appl. No.:** **29/202,136**

(57) **CLAIM**

(22) **Filed:** **Mar. 26, 2004**

The ornamental design for a combination flashlight and
keychain having a crescent shaped half moon configuration.

(51) **LOC (7) Cl.** **26-02**

(52) **U.S. Cl.** **D26/38**

(58) **Field of Search** D26/37-50; 362/157,
362/158, 171-174, 183-208, 311, 392,
804, 806

DESCRIPTION

FIG. 1 is a perspective view of the combination flashlight
and keychain having a crescent shaped half moon configu-
ration.

FIG. 2 is a left side elevational view thereof.

FIG. 3 is a right side elevational view thereof.

FIG. 4 is a front elevational view thereof.

FIG. 5 is a rear elevational view thereof.

FIG. 6 is a top plan view thereof; and,

FIG. 7 is a bottom plan view thereof.

(56) **References Cited**

U.S. PATENT DOCUMENTS

D400,326 S * 10/1998 Fisher D26/38
D425,227 S * 5/2000 Petruzzi D26/38
D442,305 S * 5/2001 Warden D26/38

1 Claim, 4 Drawing Sheets

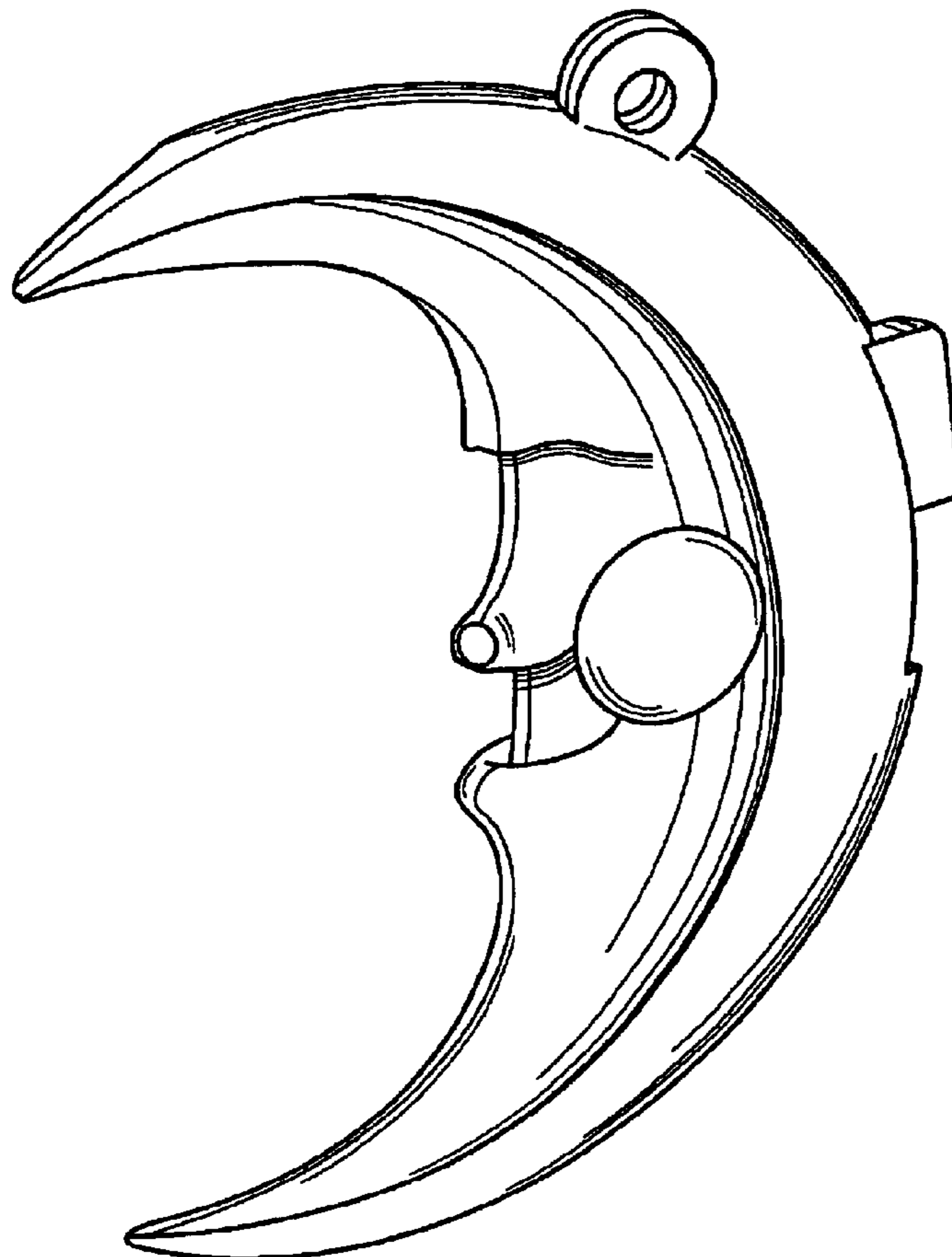

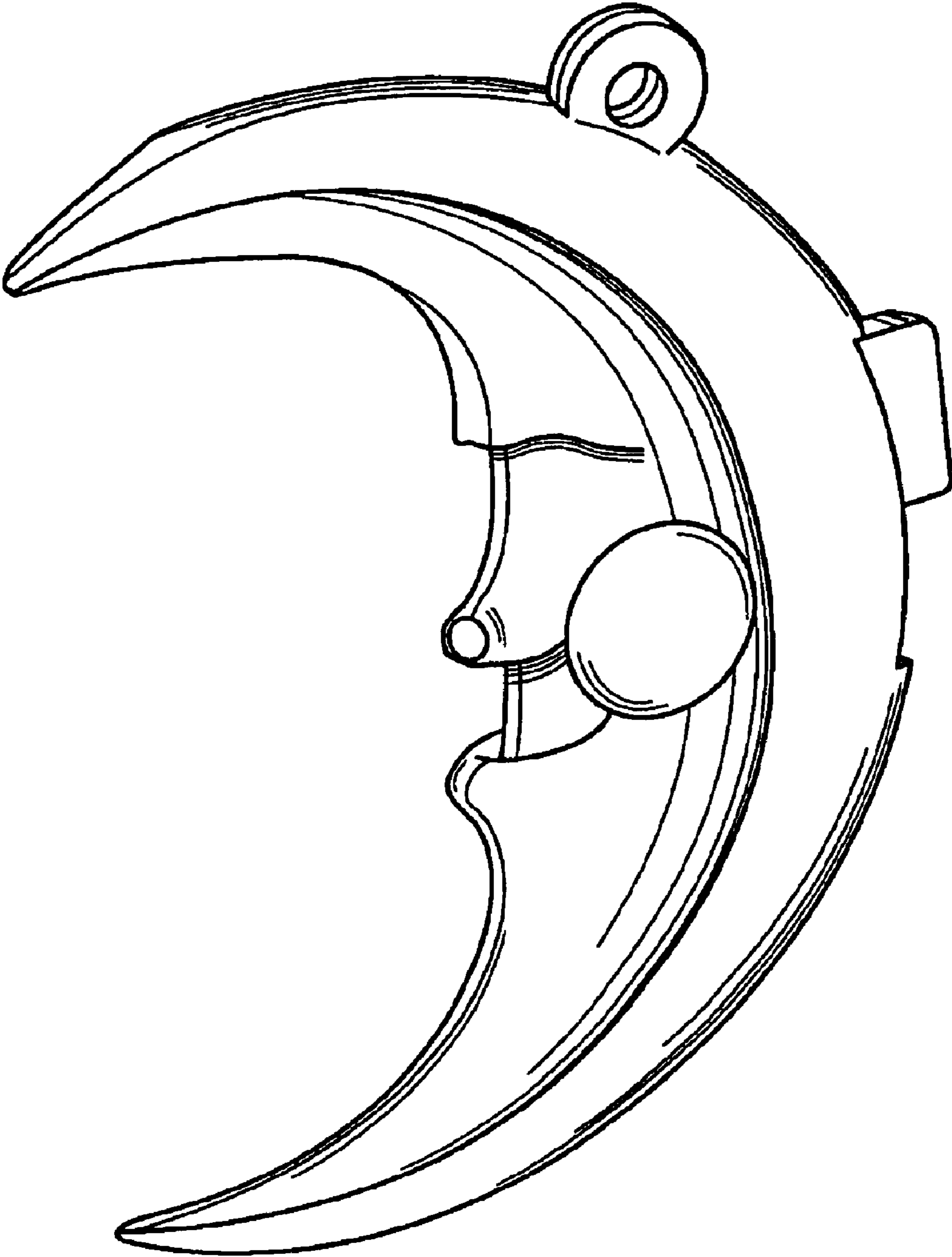

FIG. 1

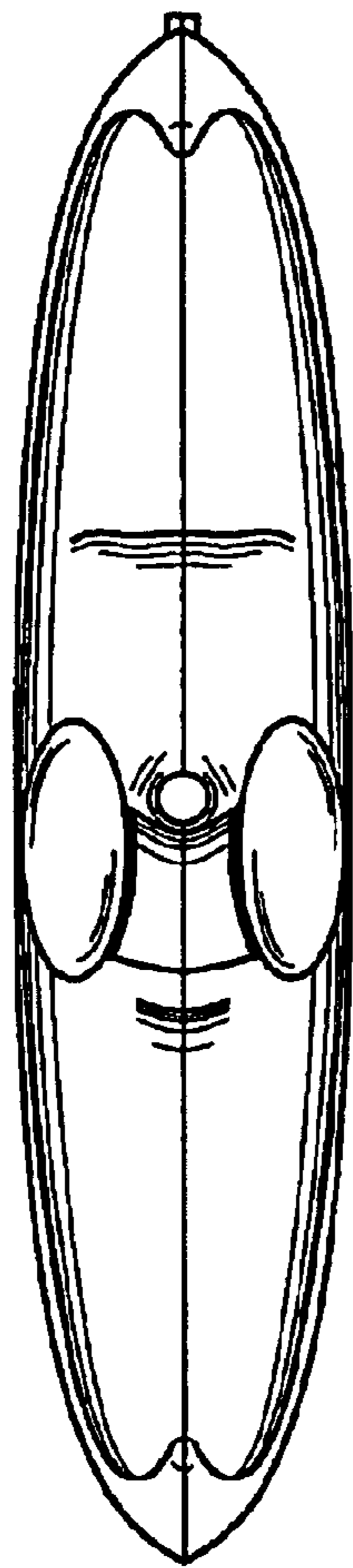

FIG. 2

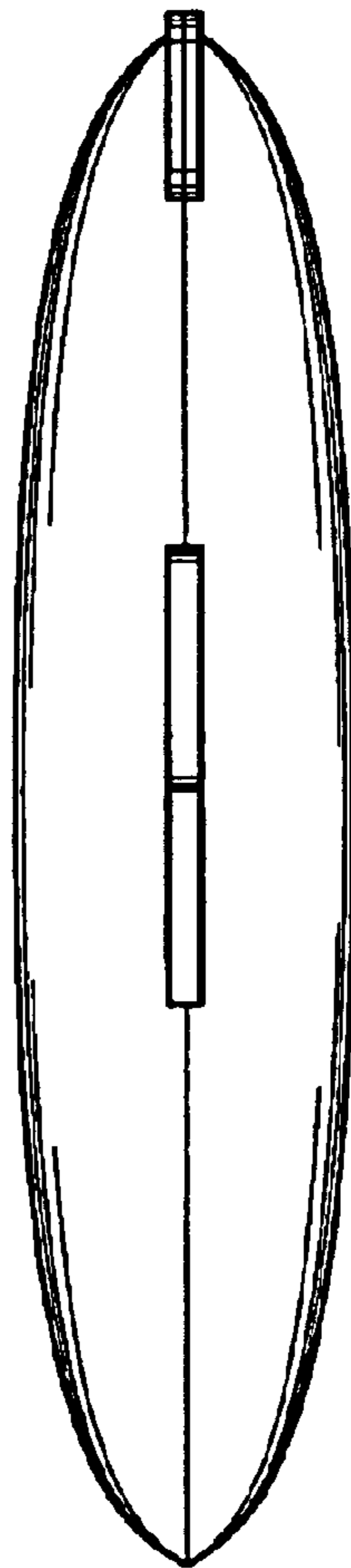

FIG. 3

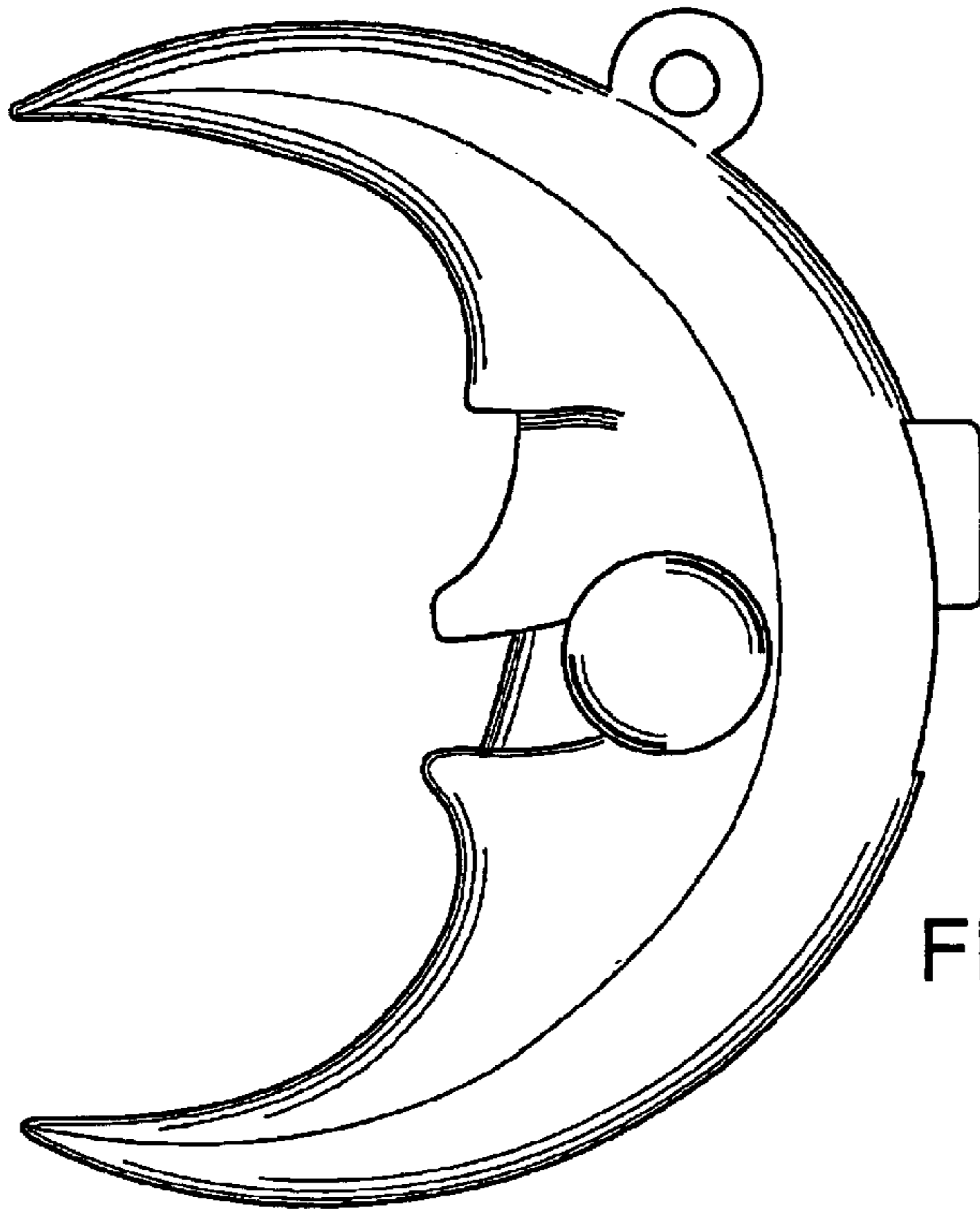

FIG. 4

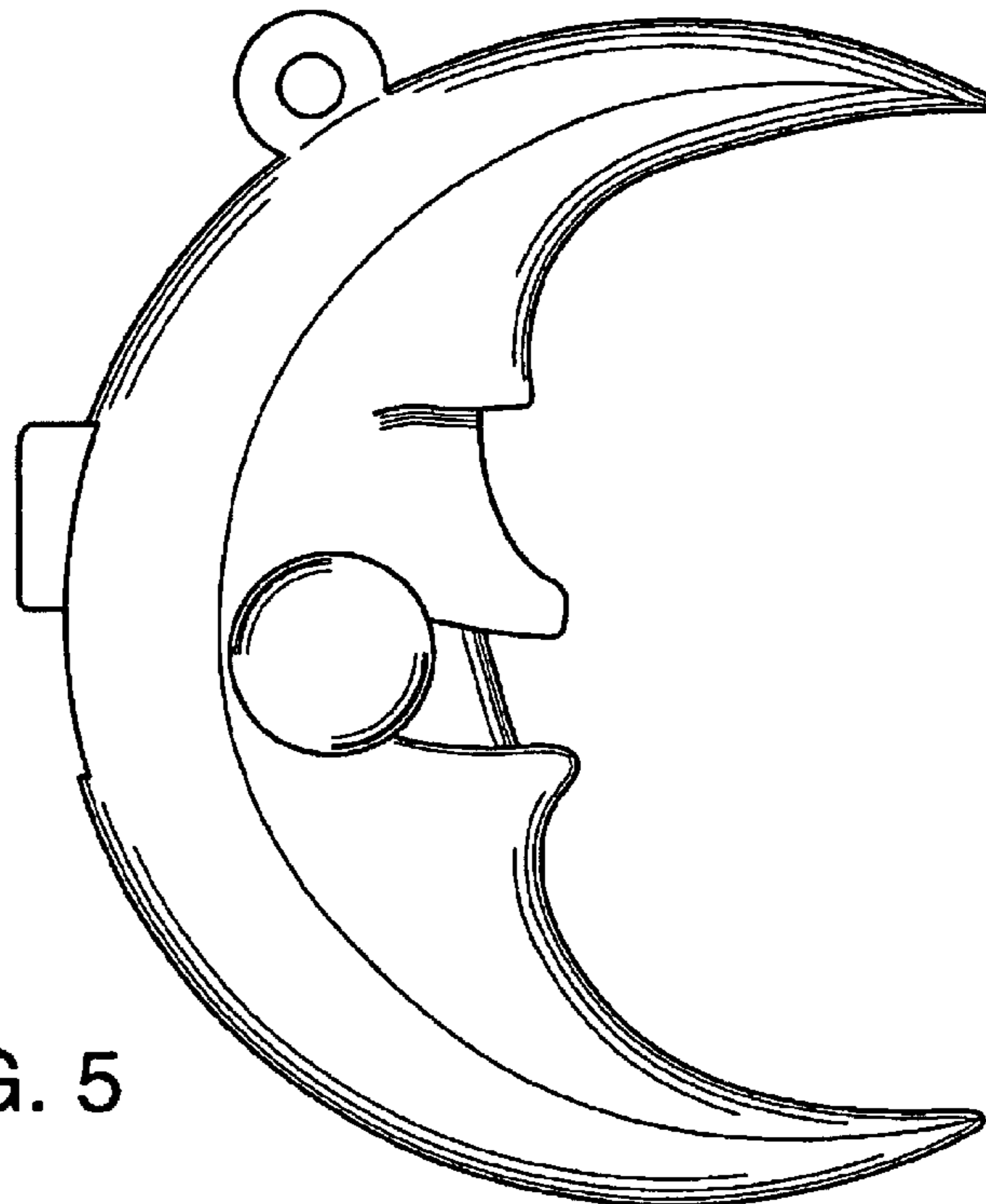

FIG. 5

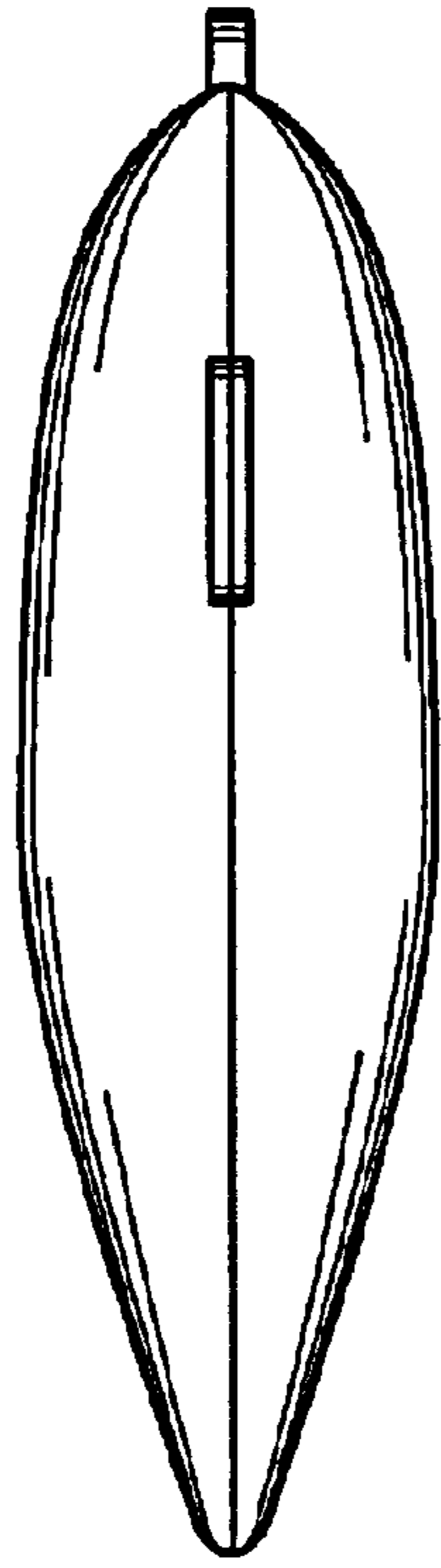

FIG. 6

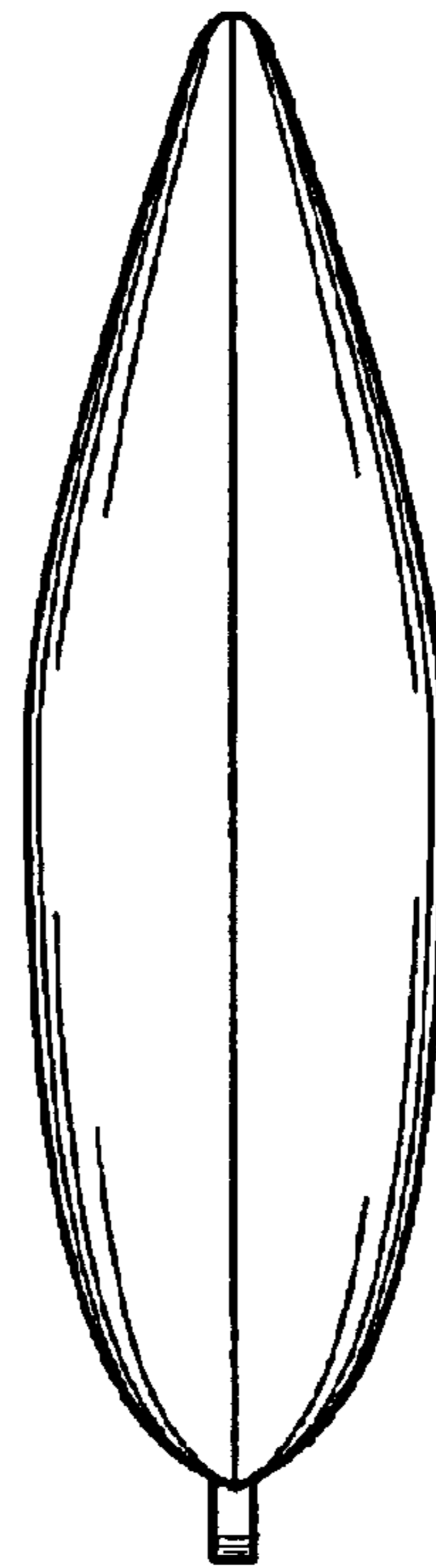

FIG. 7