

US00D499477S

(12) **United States Design Patent**  
**Burns**

(10) **Patent No.:** **US D499,477 S**

(45) **Date of Patent:** **\*\* Dec. 7, 2004**

(54) **CEILING FAN BLADE IRON**

(75) **Inventor:** **James P. Burns**, Memphis, TN (US)

(73) **Assignee:** **Hunter Fan Company**, Memphis, TN (US)

(\*\*) **Term:** **14 Years**

(21) **Appl. No.:** **29/187,204**

(22) **Filed:** **Jul. 29, 2003**

(51) **LOC (7) Cl.** ..... **23-04**

(52) **U.S. Cl.** ..... **D23/411**

(58) **Field of Search** ..... D23/411, 377,  
D23/379, 385; 416/5, 210 R; 392/364

(56) **References Cited**

**U.S. PATENT DOCUMENTS**

D404,124 S	1/1999	Tsuji	.....	D23/411
D408,078 S	4/1999	Zuege	.....	D23/411
D408,521 S	4/1999	Zuege	.....	D23/411
D408,523 S	4/1999	Thomas	.....	D23/411
D417,499 S	12/1999	Zuege	.....	D23/411
D458,362 S	6/2002	Campbell	.....	D23/411
D464,132 S	10/2002	Campbell	.....	D23/411
D477,395 S	7/2003	Thomas, Jr.	.....	D23/411
D478,382 S	8/2003	Burns	.....	D23/411

D483,110 S	*	12/2003	Hsieh	.....	D23/411
D486,219 S	*	2/2004	Hsieh	.....	D23/411
D486,221 S	*	2/2004	Hsieh	.....	D23/411

\* cited by examiner

*Primary Examiner*—Lisa Lichtenstein

(74) *Attorney, Agent, or Firm*—Baker Donelson

(57) **CLAIM**

The ornamental design for a ceiling fan blade iron, as shown and described.

**DESCRIPTION**

FIG. 1 is a perspective view of a ceiling fan blade iron showing my new design, shown in an inverted position for clarity.

FIG. 2 is a bottom view thereof.

FIG. 3 is a top view thereof.

FIG. 4 is a right side view thereof.

FIG. 5 is a left side view thereof.

FIG. 6 is a front view thereof; and,

FIG. 7 is a rear view thereof.

The broken lines in the views show environmental features which are for illustrative purposes only and form no part of the claimed design.

**1 Claim, 4 Drawing Sheets**

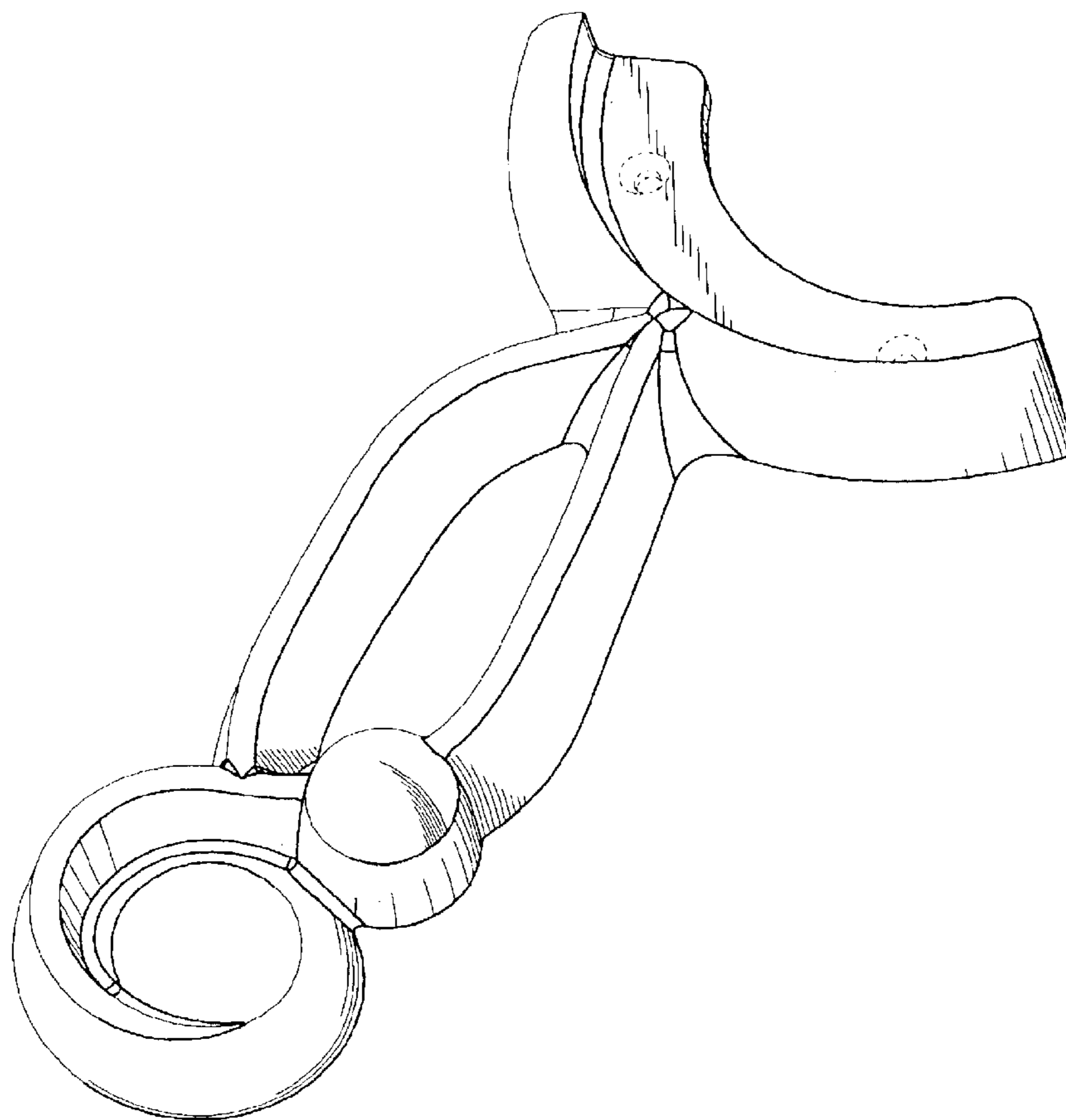

Fig. 1

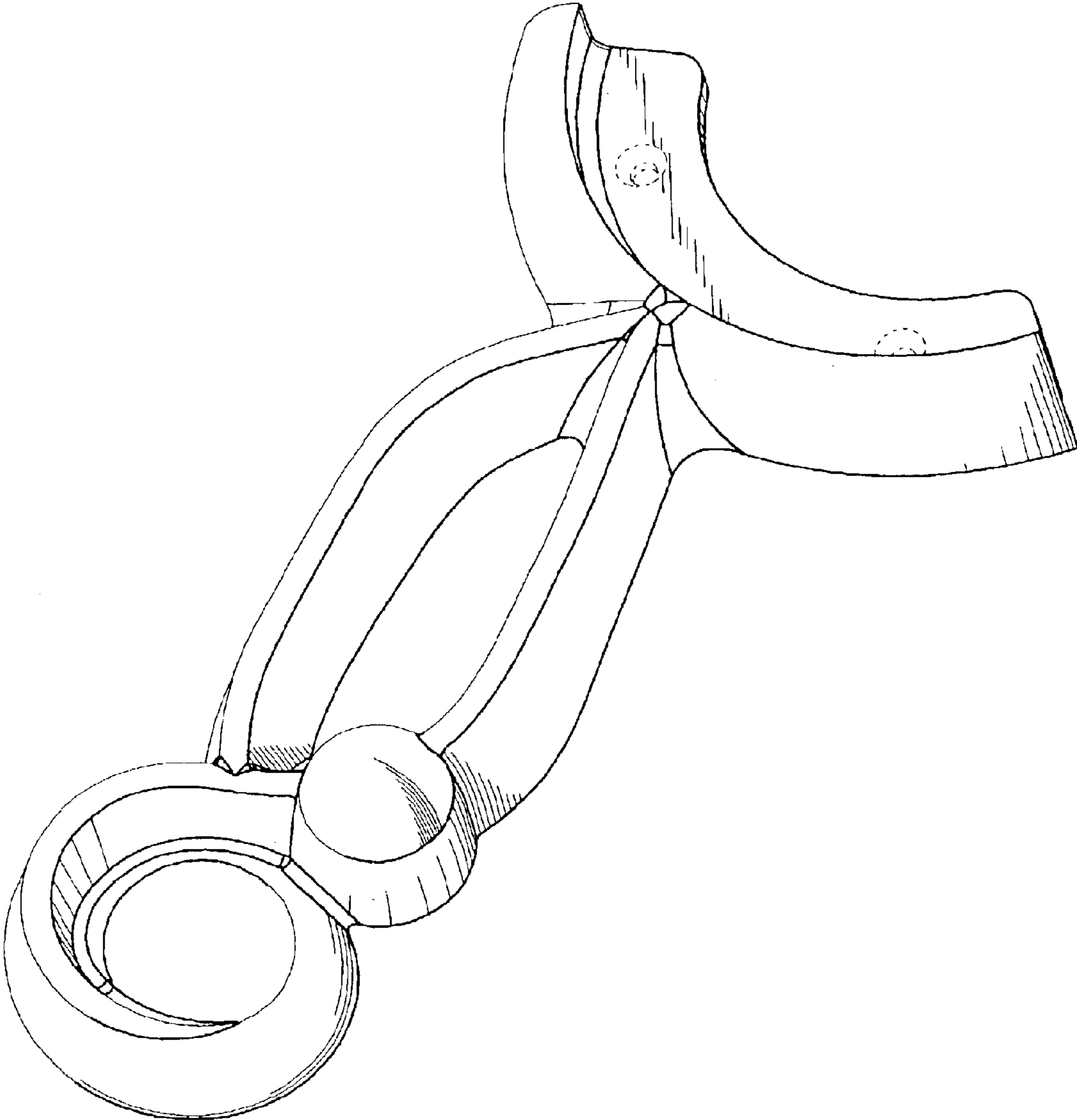

Fig. 2

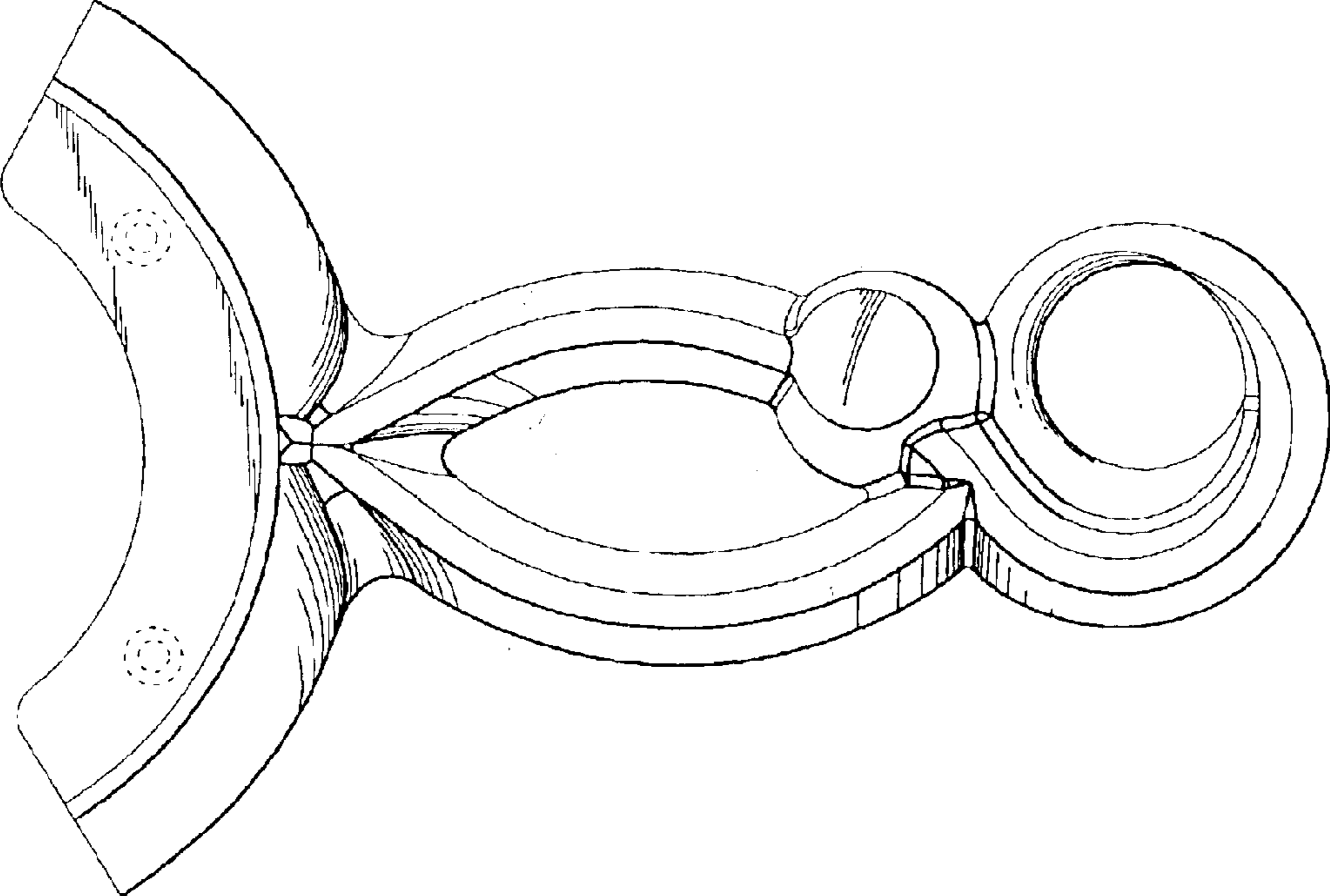

Fig. 3

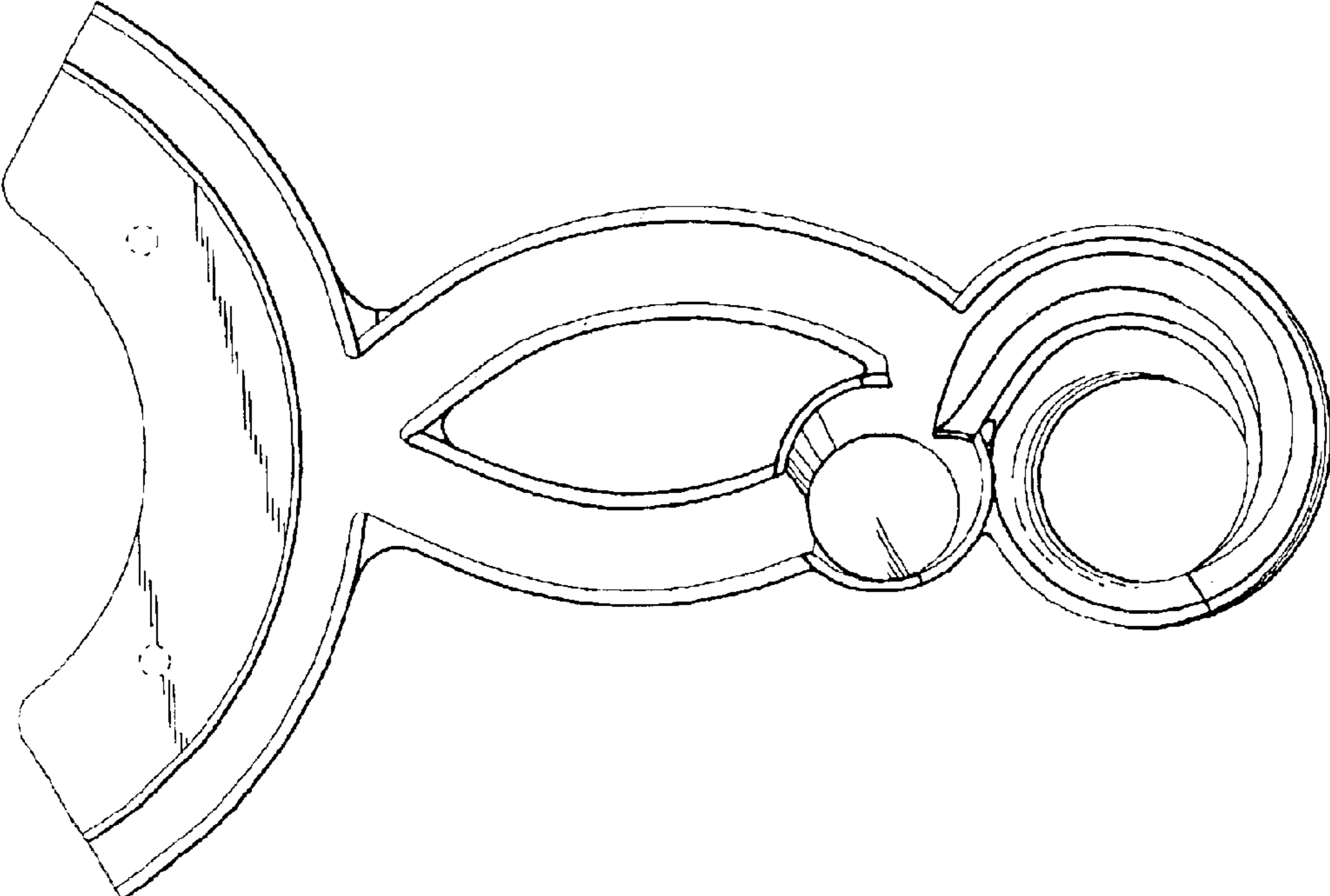

Fig. 4

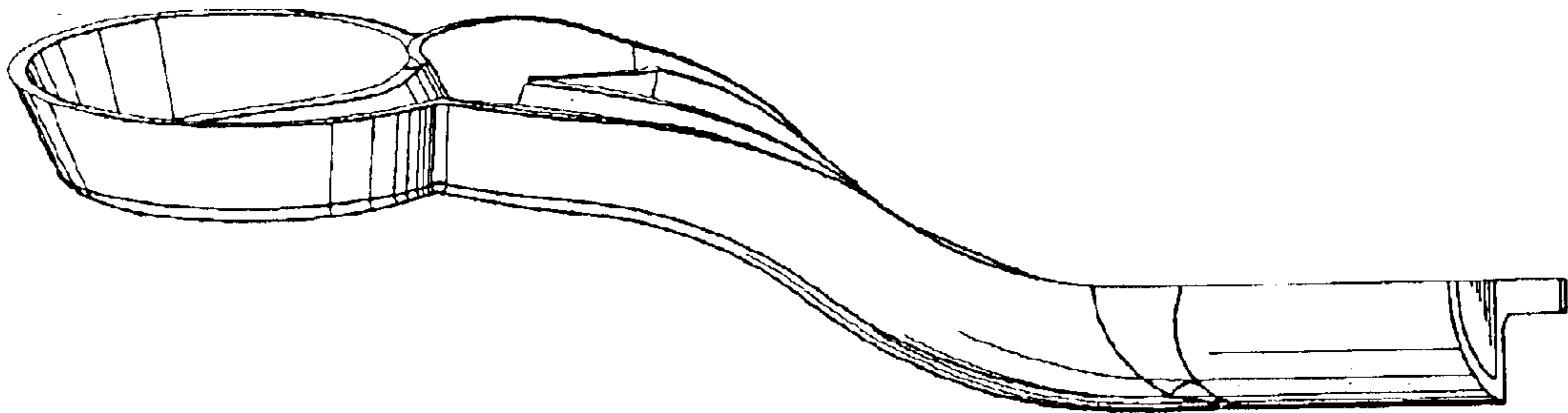

Fig. 5

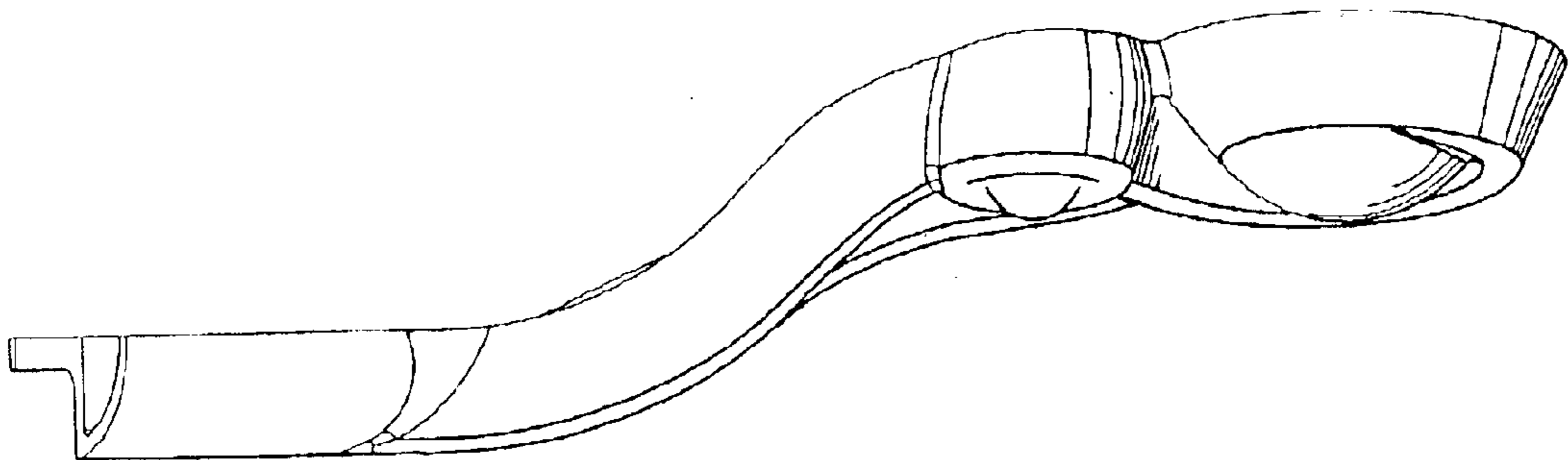

Fig. 6

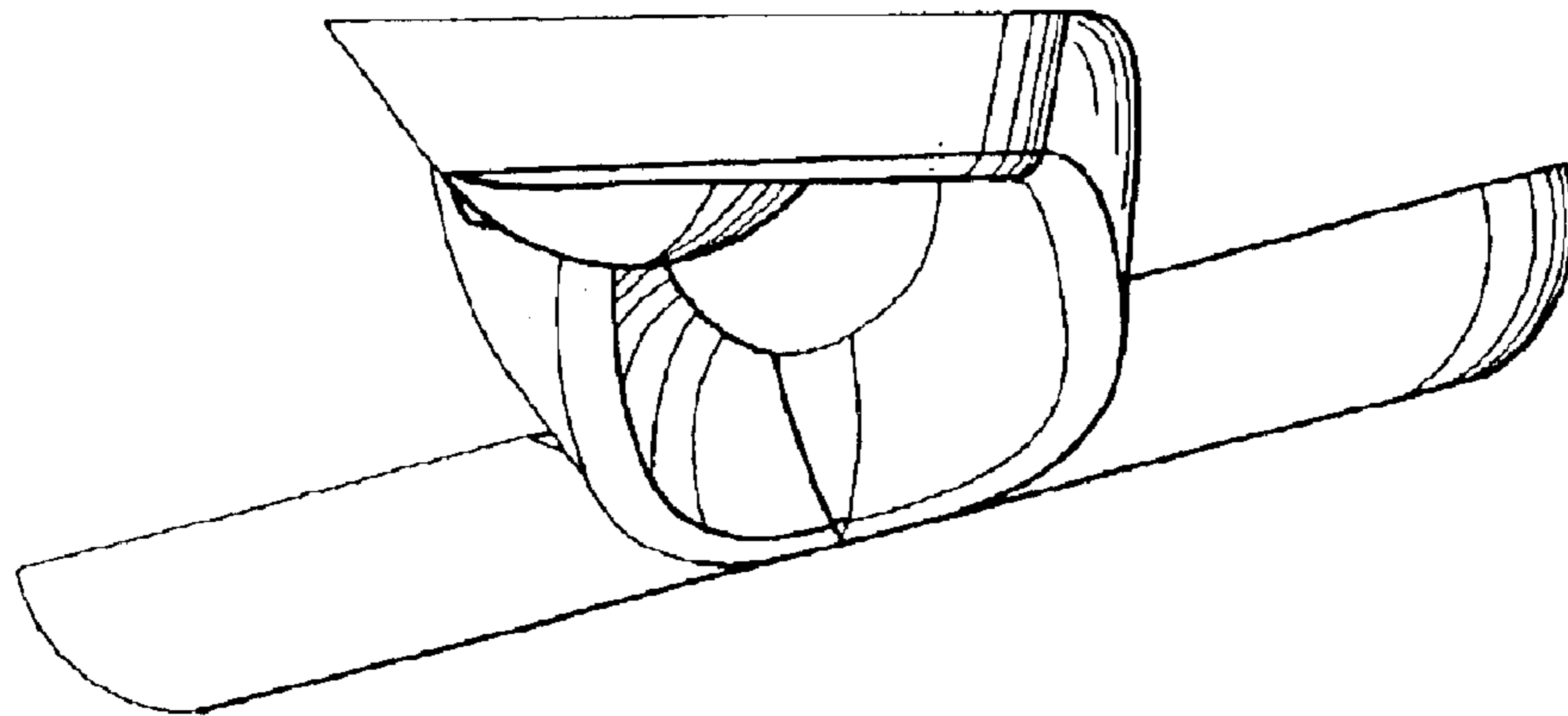

Fig. 7

