

US00D499403S

(12) **United States Design Patent**
Hart et al.

(10) **Patent No.:** **US D499,403 S**
(45) **Date of Patent:** **** Dec. 7, 2004**

(54) **DATA CARD**

D490,103 S * 5/2004 Rangel et al. D19/10

(75) Inventors: **Allison M. Hart**, Charlotte, NC (US);
Rebecka D. Keelan Nelli, Charlotte,
NC (US); **R. Bruce Montgomery, Jr.**,
Charlotte, NC (US)

* cited by examiner

Primary Examiner—M. H. Tung
(74) *Attorney, Agent, or Firm*—Moore & Van Allen PLLC;
Michael G. Johnston

(73) Assignee: **Bank of America Corporation**,
Charlotte, NC (US)

(57) **CLAIM**

The ornamental design for a data card, as shown and
described.

(**) Term: **14 Years**

DESCRIPTION

(21) Appl. No.: **29/196,569**

FIG. 1 is a perspective view of a data card showing our new
design.

(22) Filed: **Dec. 31, 2003**

FIG. 2 is a top plan view of the data card as shown in FIG.
1 showing our new design.

(51) **LOC (7) Cl.** **14-02**

(52) **U.S. Cl.** **D14/436**

FIG. 3 is a front elevational view of the data card as shown
in FIG. 1 showing our new design.

(58) **Field of Search** D14/432-38; 361/736-7,
361/686; D13/182, 184; 40/124.01; 235/487-95,
441-3, 375; 283/900, 904; 257/378-9;
174/52.1; 439/135, 140, 76.1; D19/9, 10

FIG. 4 is a left side view of the data card as shown in FIG.
1 showing our new design.

FIG. 5 is a right side view of the data card as shown in FIG.
1 showing our new design.

(56) **References Cited**

U.S. PATENT DOCUMENTS

6,012,636	A	*	1/2000	Smith	235/380
D453,160	S		1/2002	Pentz et al.		
D453,161	S		1/2002	Pentz		
D453,336	S	*	2/2002	Pentz et al.	D14/436
D453,337	S	*	2/2002	Pentz et al.	D14/436
D453,338	S	*	2/2002	Pentz et al.	D14/436
D453,339	S	*	2/2002	Pentz	D14/436
D453,516	S	*	2/2002	Pentz	D14/436
D453,517	S	*	2/2002	Pentz	D14/436
D454,910	S	*	3/2002	Smith et al.	D19/9
D456,814	S	*	5/2002	Pentz	D14/436
D457,556	S	*	5/2002	Hochschild	D19/9
D460,454	S	*	7/2002	Pentz	D14/436
D460,455	S	*	7/2002	Pentz	D14/436
D461,477	S	*	8/2002	Pentz	D14/436
D462,714	S	*	9/2002	Creighton	D19/9
D462,965	S	*	9/2002	Pentz	D14/436
D462,966	S		9/2002	Pentz et al.		
D467,247	S		12/2002	Pentz		
D478,622	S	*	8/2003	Grayson	D19/10
D487,480	S	*	3/2004	Nelms et al.	D19/9

FIG. 6 is a rear elevational view of the data card as shown
in FIG. 1 showing our new design.

FIG. 7 is a bottom plan view of the data card as shown in
FIG. 1 showing our new design.

FIG. 8 is a perspective view of a second embodiment of a
data card showing our new design.

FIG. 9 is a top plan view of the data card as shown in FIG.
8 showing our new design.

FIG. 10 is a front elevational view of the data card as shown
in FIG. 8 showing our new design.

FIG. 11 is a left side view of the data card as shown in FIG.
8 showing our new design.

FIG. 12 is a right side view of the data card as shown in FIG.
8 showing our new design.

FIG. 13 is a rear elevational view of the data card as shown
in FIG. 8 showing our new design.

FIG. 14 is a bottom plan view of the data card as shown in
FIG. 8 showing our new design.

FIG. 15 is a perspective view of a third embodiment of a data
card showing our new design.

FIG. 16 is a top plan view of the data card as shown in FIG.
15 showing our new design.

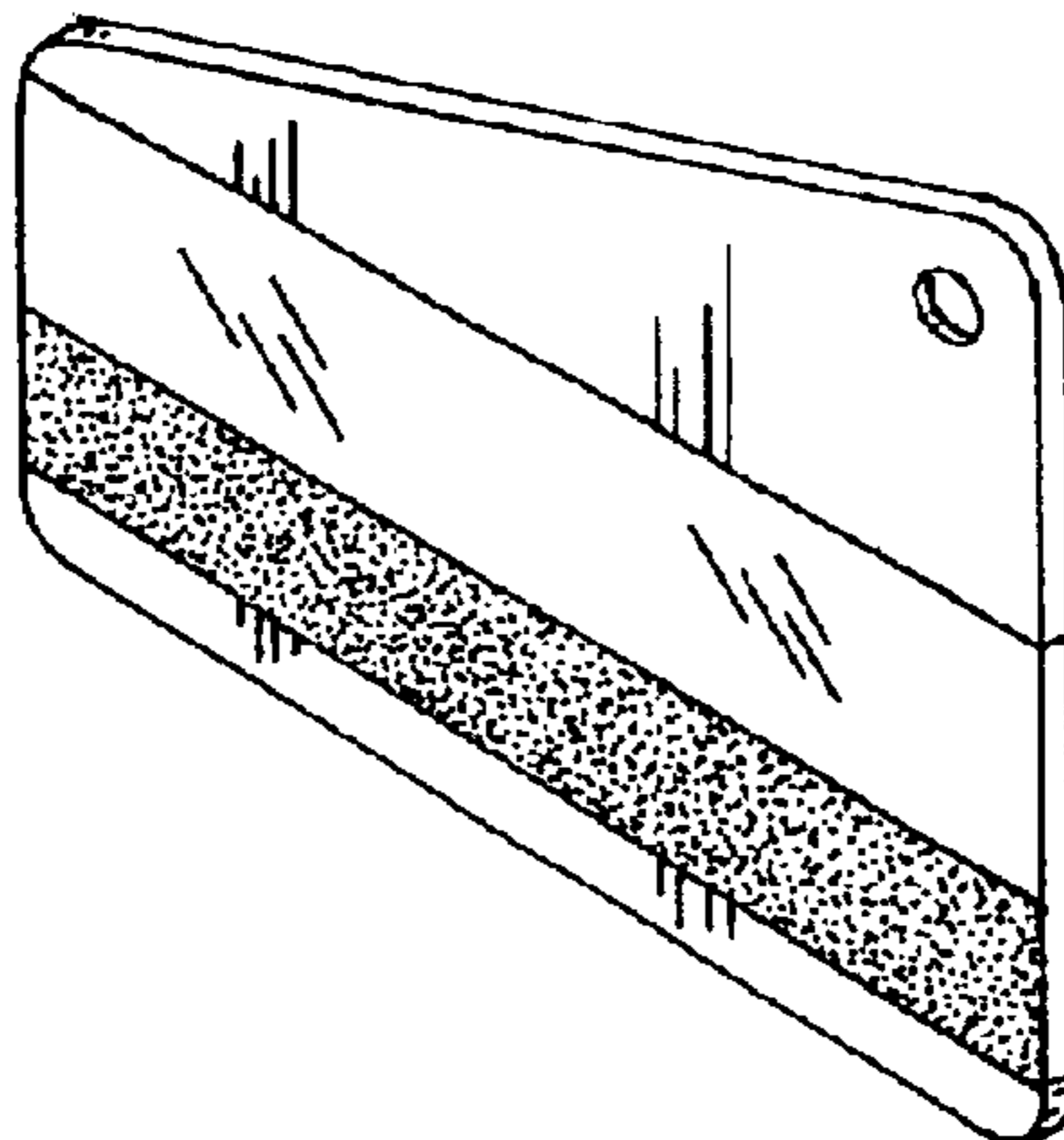

FIG. 17 is a front elevational view of the data card as shown in FIG. 15 showing our new design.

FIG. 18 is a left side view of the data card as shown in FIG. 15 showing our new design.

FIG. 19 is a right side view of the data card as shown in FIG. 15 showing our new design.

FIG. 20 is a rear elevational view of the data card as shown in FIG. 15 showing our new design.

FIG. 21 is a bottom plan view of the data card as shown in FIG. 15 showing our new design.

FIG. 22 is a perspective view of a fourth embodiment of a data card showing our new design.

FIG. 23 is a top plan view of the data card as shown in FIG. 22 showing our new design.

FIG. 24 is a front elevational view of the data card as shown in FIG. 22 showing our new design.

FIG. 25 is a left side view of the data card as shown in FIG. 22 showing our new design.

FIG. 26 is a right side view of the data card as shown in FIG. 22 showing our new design.

FIG. 27 is a rear elevational view of the data card as shown in FIG. 22 showing our new design; and,

FIG. 28 is a bottom plan view of the data card as shown in FIG. 22 showing our new design.

1 Claim, 4 Drawing Sheets

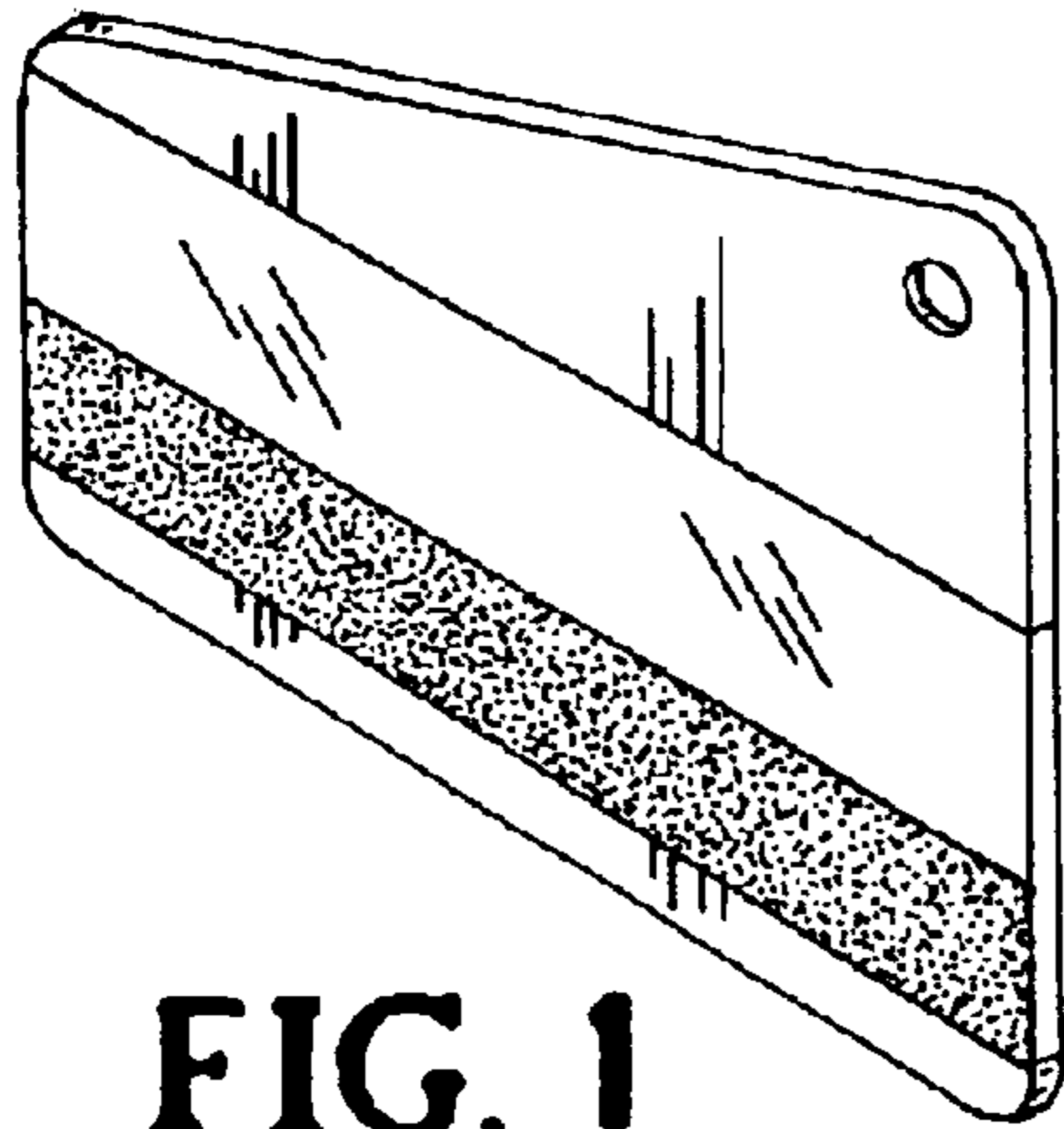

FIG. 1

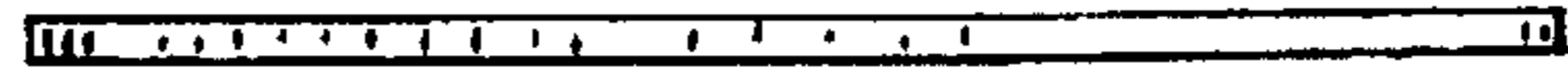

FIG. 2

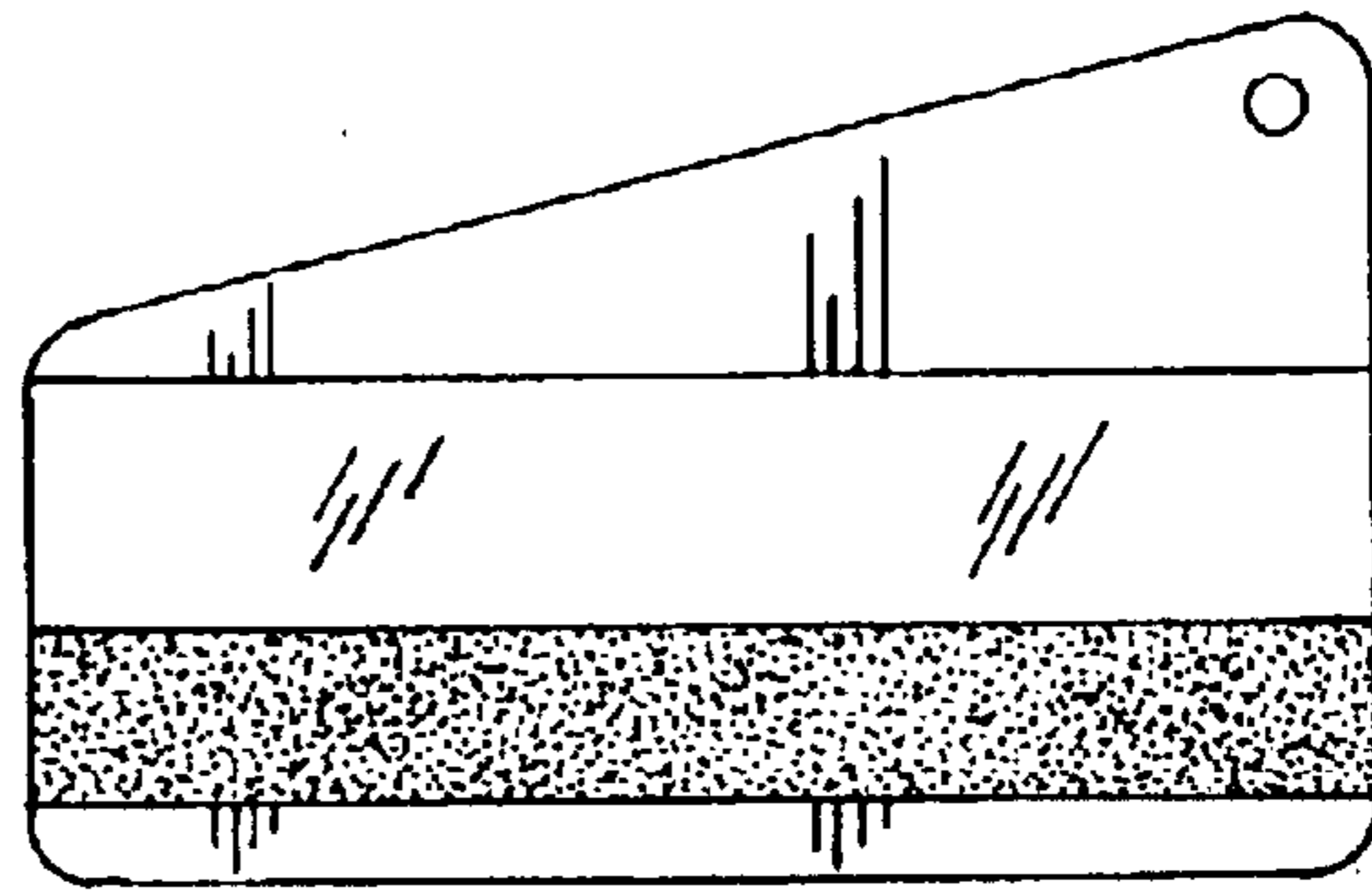

FIG. 3



FIG. 4



FIG. 5

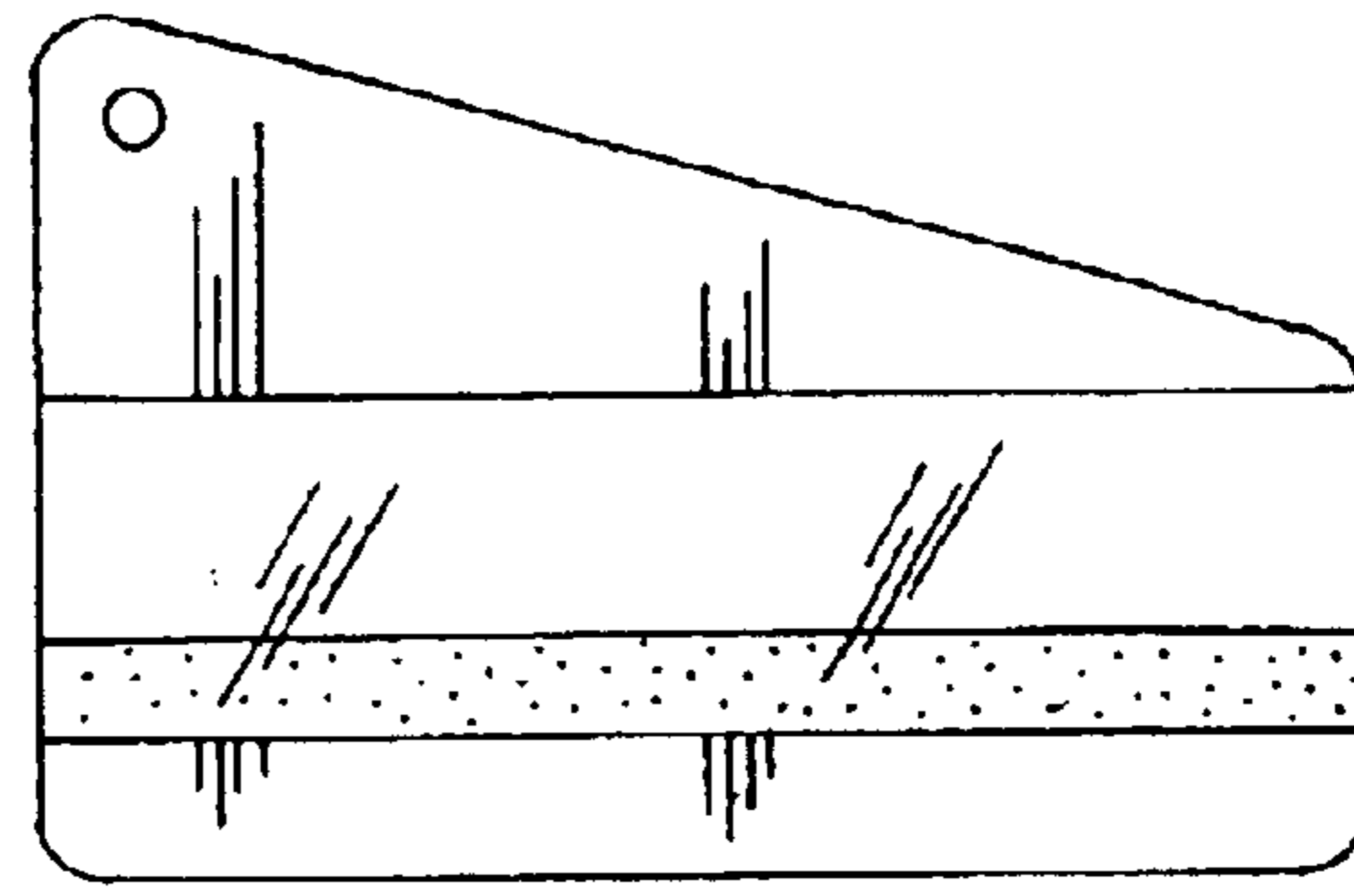

FIG. 6

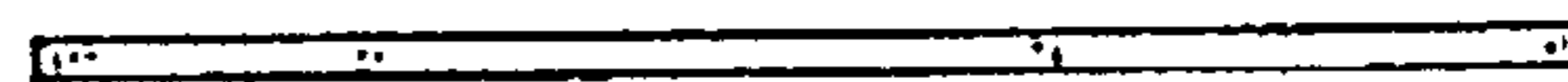

FIG. 7

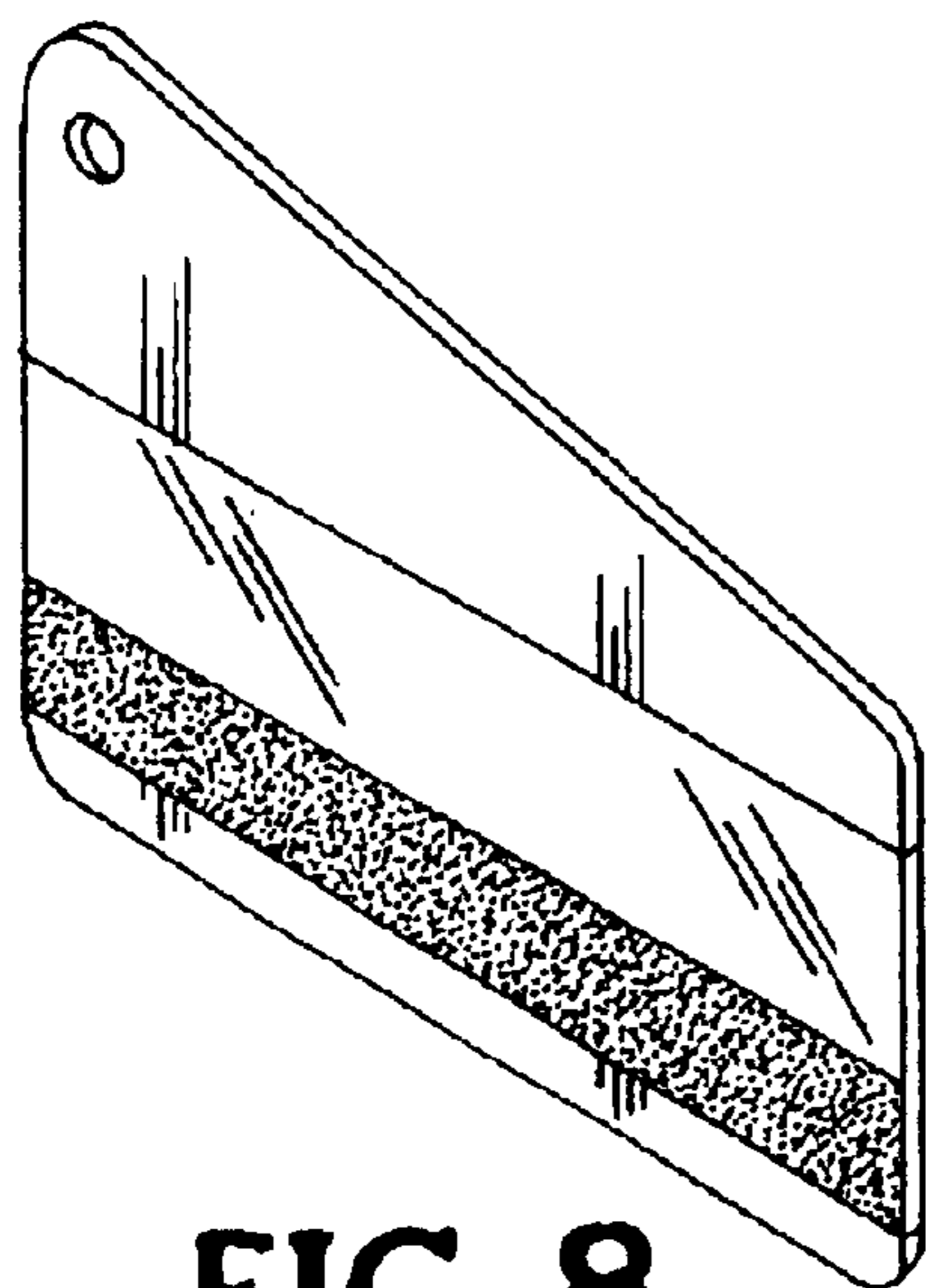

FIG. 8



FIG. 9

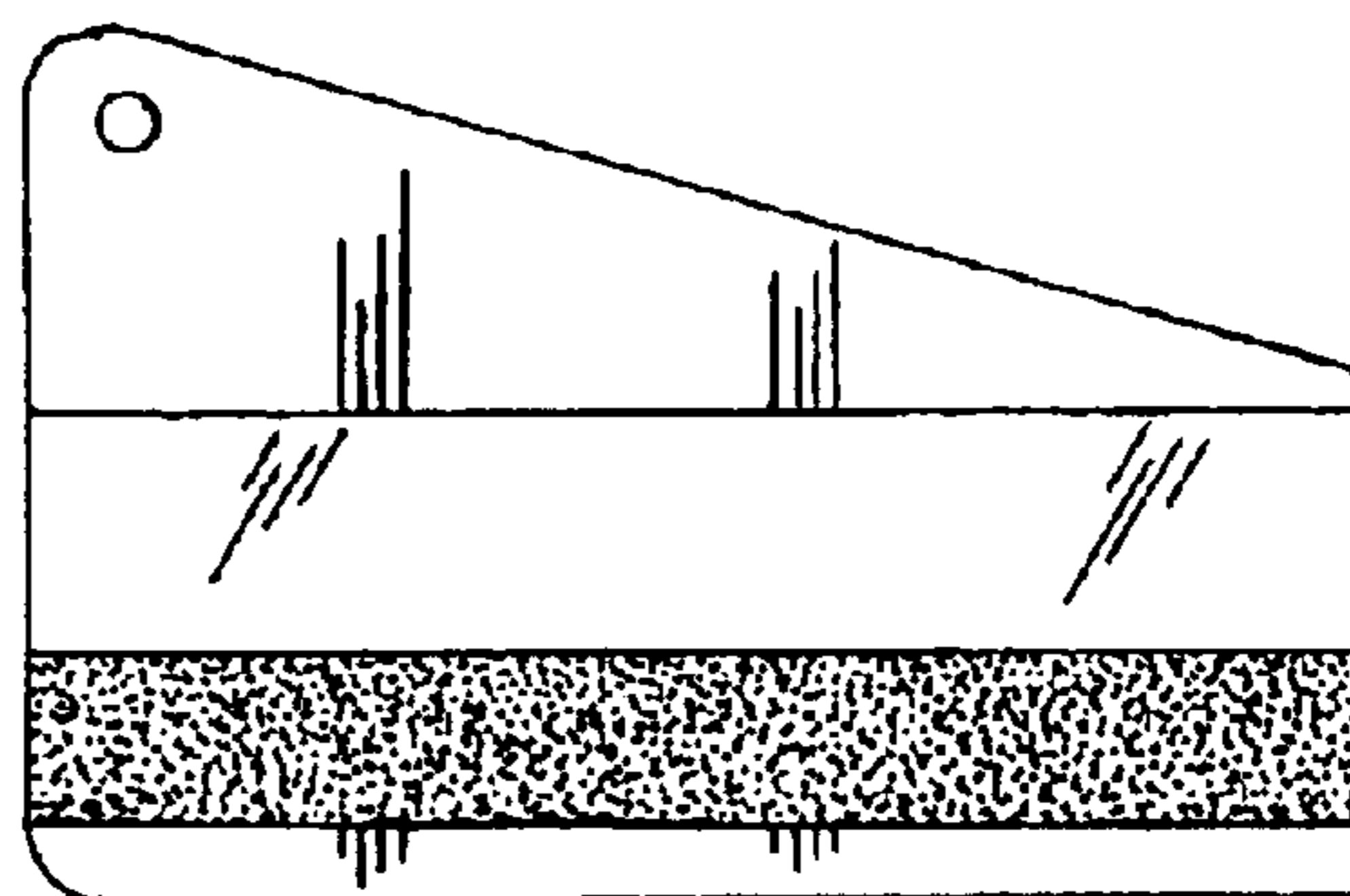

FIG. 10



FIG. 11



FIG. 12

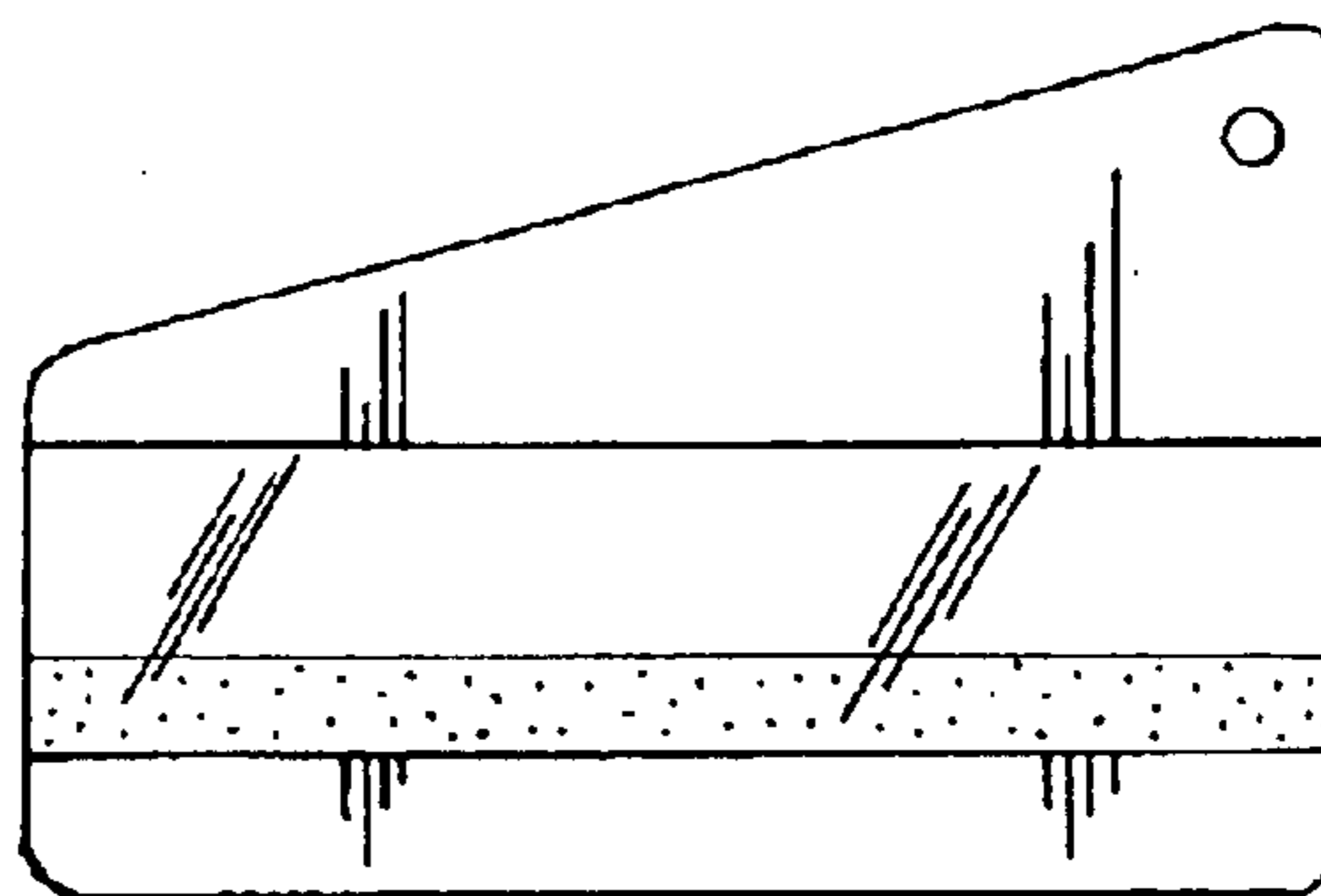

FIG. 13



FIG. 14

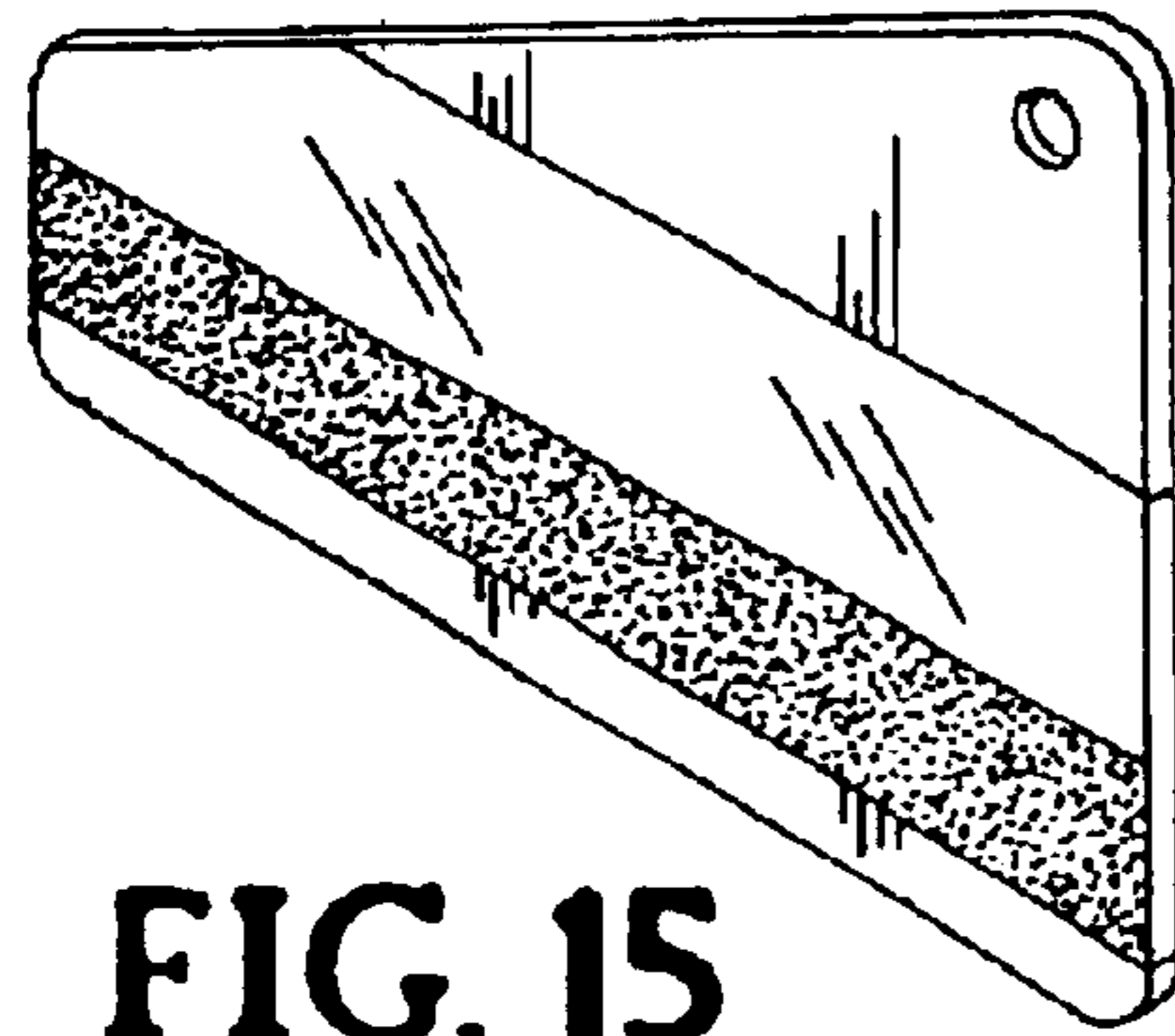

FIG. 15

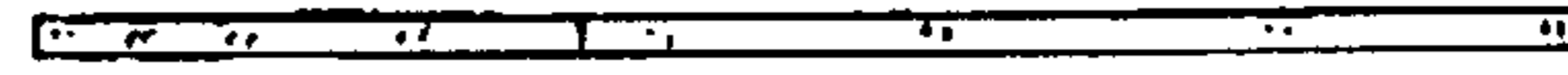

FIG. 16

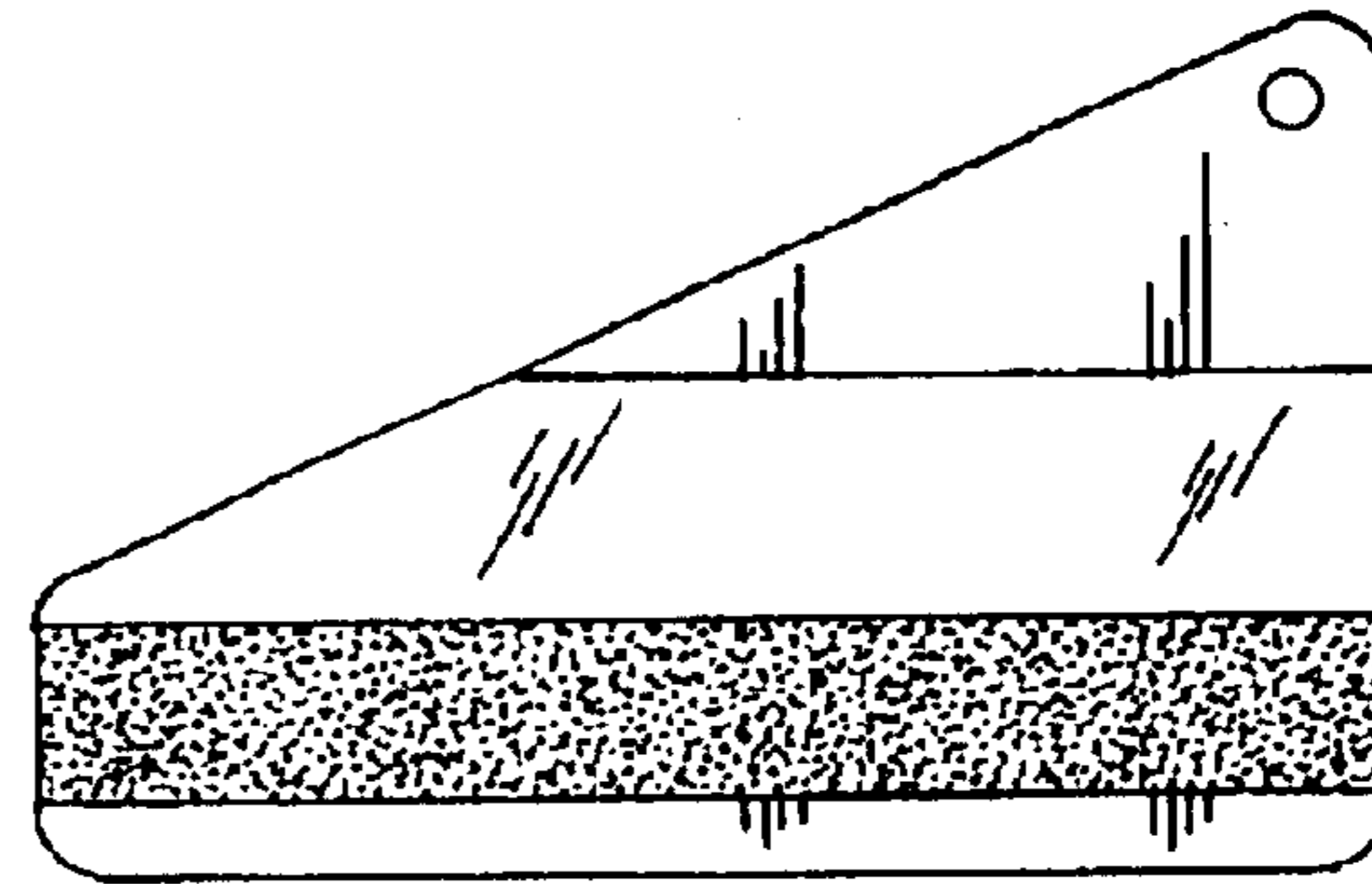

FIG. 17



FIG. 18



FIG. 19

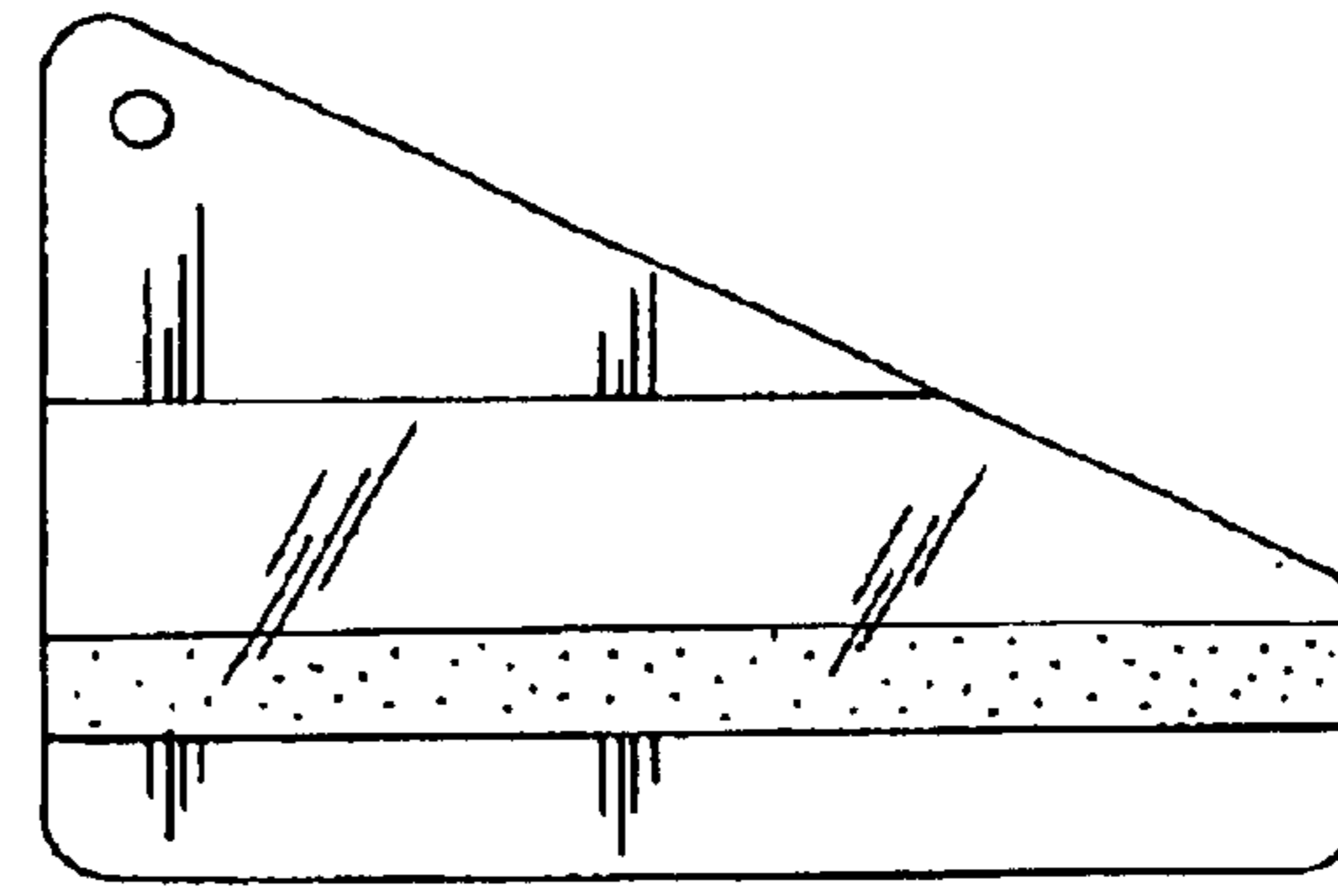

FIG. 20

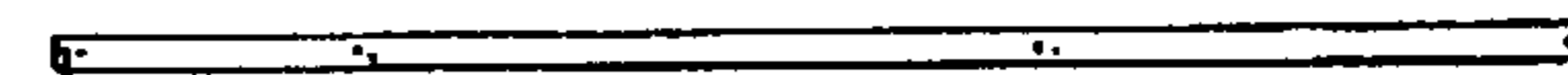

FIG. 21

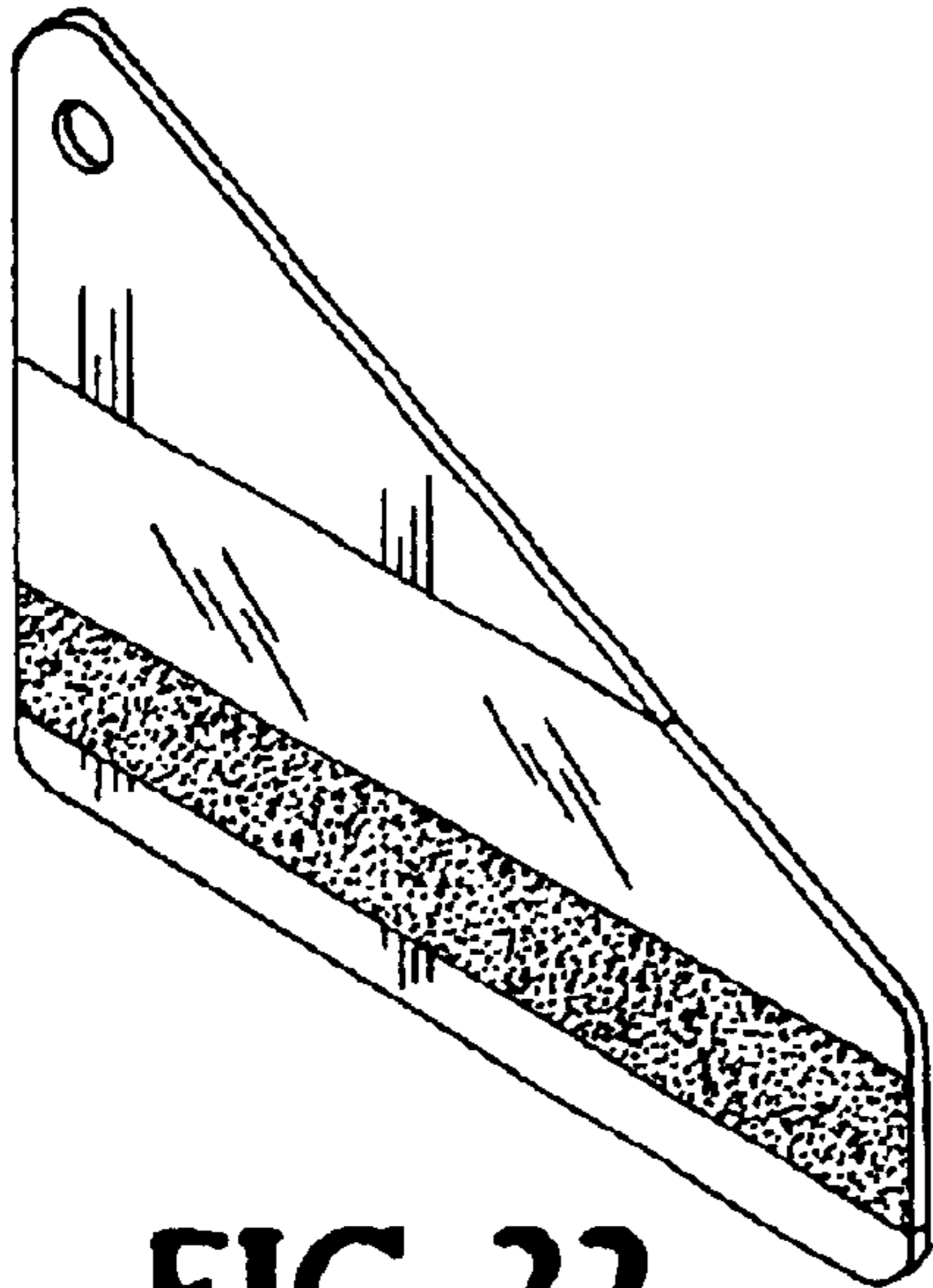

FIG. 22

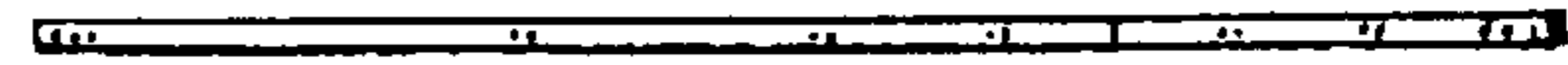

FIG. 23

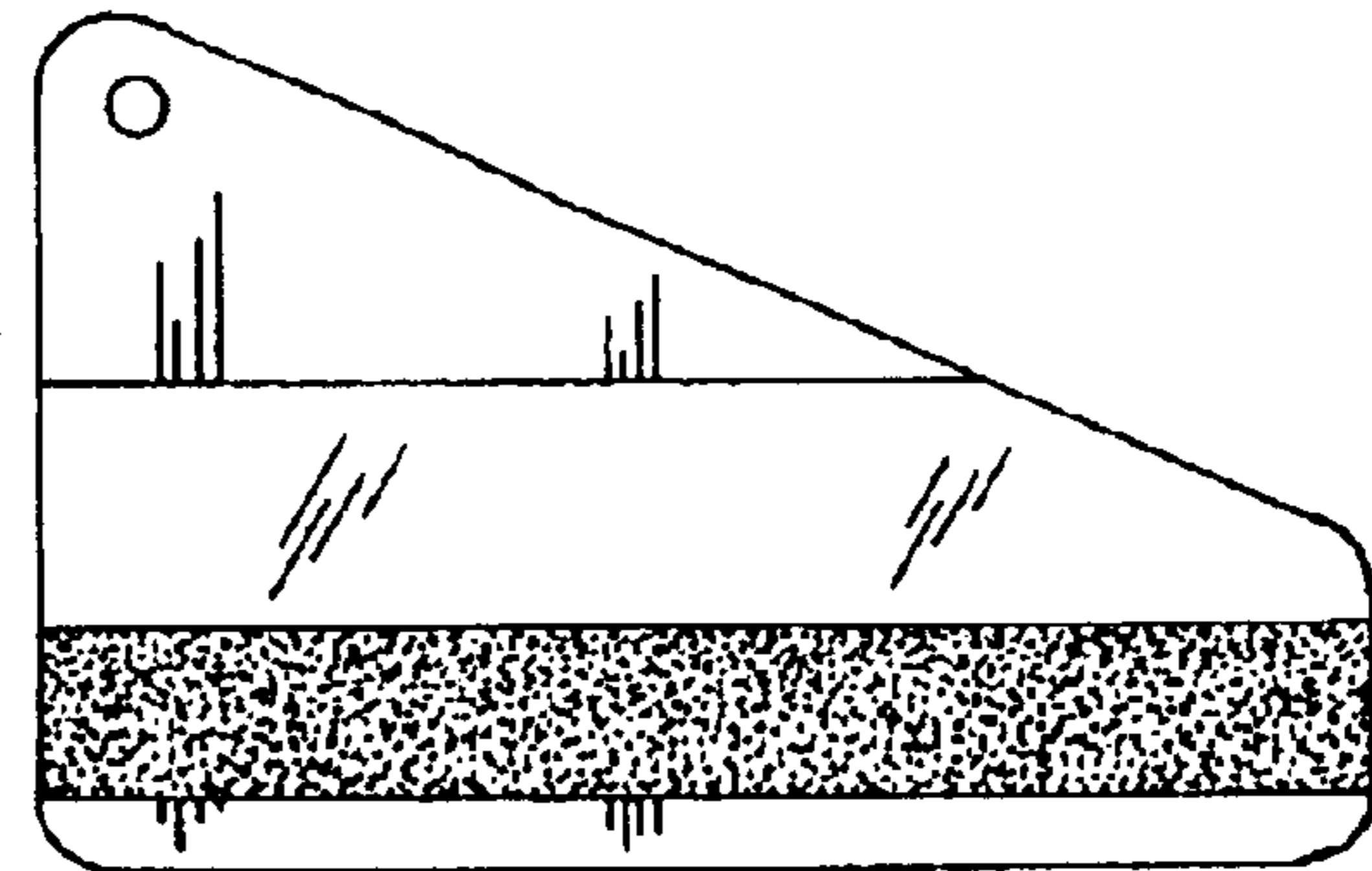

FIG. 24



FIG. 25

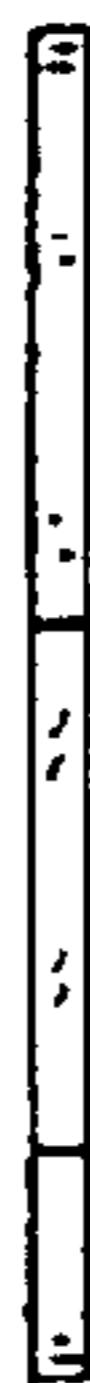

FIG. 26

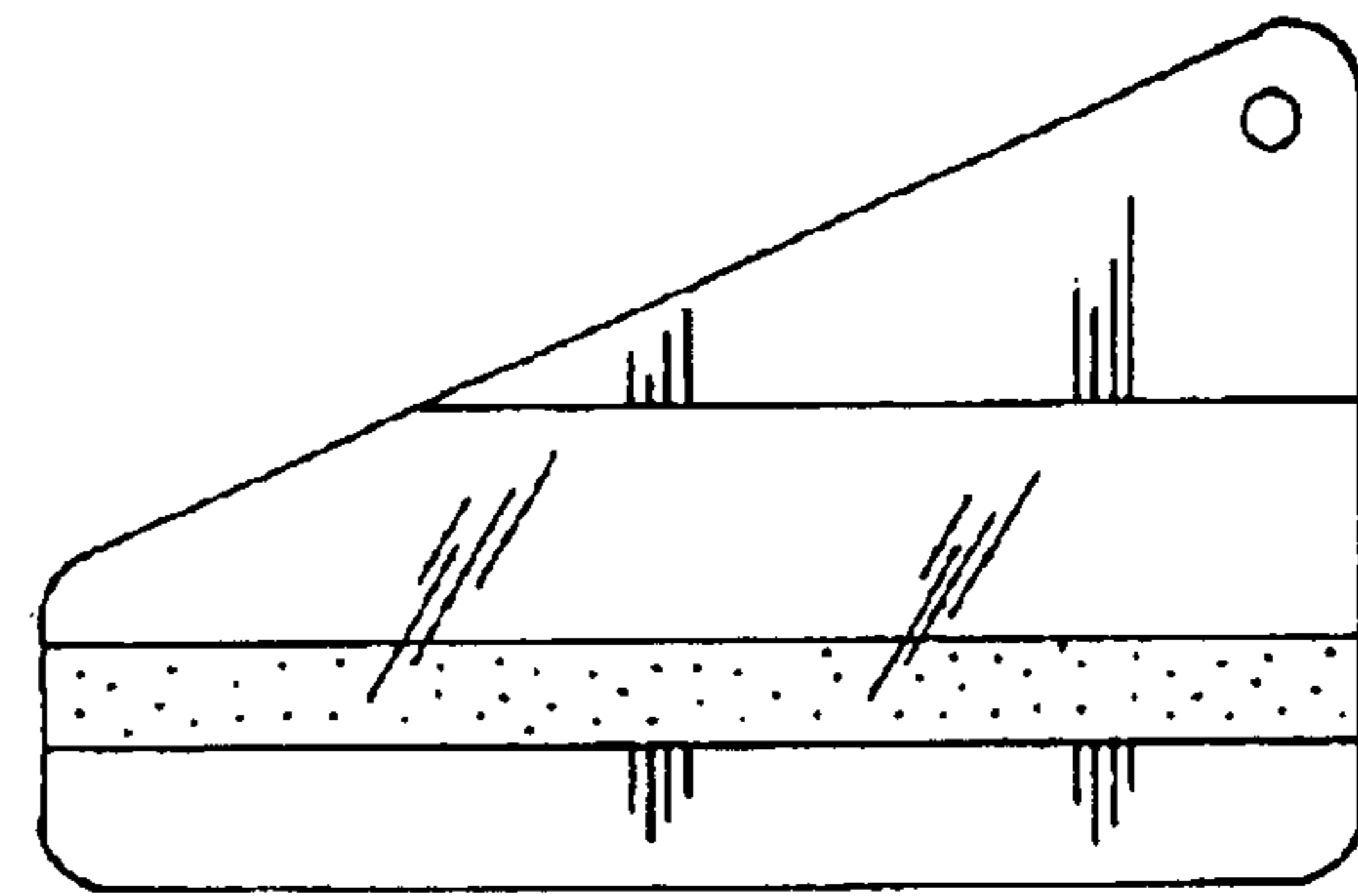

FIG. 27



FIG. 28