



US00D499280S

(12) **United States Design Patent** (10) **Patent No.:** **US D499,280 S**
Ohtake (45) **Date of Patent:** **** Dec. 7, 2004**

- (54) **REFRIGERATED SHOWCASE**
 (75) Inventor: **Tomihiro Ohtake**, Aichi (JP)
 (73) Assignee: **Hoshizaki Denki Kabushiki Kaisha**,
 Aichi-ken (JP)
 (**) Term: **14 Years**
 (21) Appl. No.: **29/182,328**
 (22) Filed: **May 27, 2003**

Related U.S. Application Data

- (62) Division of application No. 29/147,799, filed on Sep. 7, 2001, now Pat. No. Des. 478,744.

(30) **Foreign Application Priority Data**

Mar. 12, 2001	(JP)	2001-006208
Mar. 12, 2001	(JP)	2001-006209
Mar. 12, 2001	(JP)	2001-006210
Mar. 12, 2001	(JP)	2001-006211

- (51) **LOC (7) Cl.** **06-04**
 (52) **U.S. Cl.** **D6/471; D15/81**
 (58) **Field of Search** **D6/396, 397, 408,**
D6/449, 470-472; D15/81-85; 312/114,
116

(56) **References Cited**

U.S. PATENT DOCUMENTS

D162,157 S	*	2/1951	Grieling	D6/470
D162,708 S	*	4/1951	Bently	D6/470
D203,489 S	*	1/1966	Cullen	D6/471
D350,658 S	*	9/1994	Graat	D6/471

* cited by examiner

Primary Examiner—Cathron Brooks
 (74) *Attorney, Agent, or Firm*—Wenderoth, Lind & Ponack,
 L.L.P.

(57) **CLAIM**

The ornamental design for refrigerated showcase, as shown and described.

DESCRIPTION

FIG. 1 is a front elevational view of a first embodiment of a refrigerated showcase, showing our new design;
 FIG. 2 is a rear elevational view thereof;
 FIG. 3 is a left side elevational view thereof;
 FIG. 4 is a top plan view thereof;
 FIG. 5 is a bottom plan view thereof;
 FIG. 6 is a perspective view thereof;
 FIG. 7 is a greatly enlarged cross-sectional view thereof, taken along line 7—7 in FIG. 1;
 FIG. 8 is a greatly enlarged cross-sectional view thereof, taken along line 8—8 in FIG.1;
 FIG. 9 is a front elevational view of a second embodiment of a refrigerated showcase, showing our new design;
 FIG. 10 is a rear elevational view thereof;
 FIG. 11 is a left side elevational view thereof;
 FIG. 12 is a top plan view thereof;
 FIG. 13 is a bottom plan view thereof;
 FIG. 14 is a perspective view thereof;
 FIG. 15 is a greatly enlarged cross-sectional view thereof, taken along line 15—15 in FIG. 9; and,
 FIG. 16 is an enlarged cross-sectional view thereof, taken along line 16—16 in FIG. 9.

1 Claim, 12 Drawing Sheets

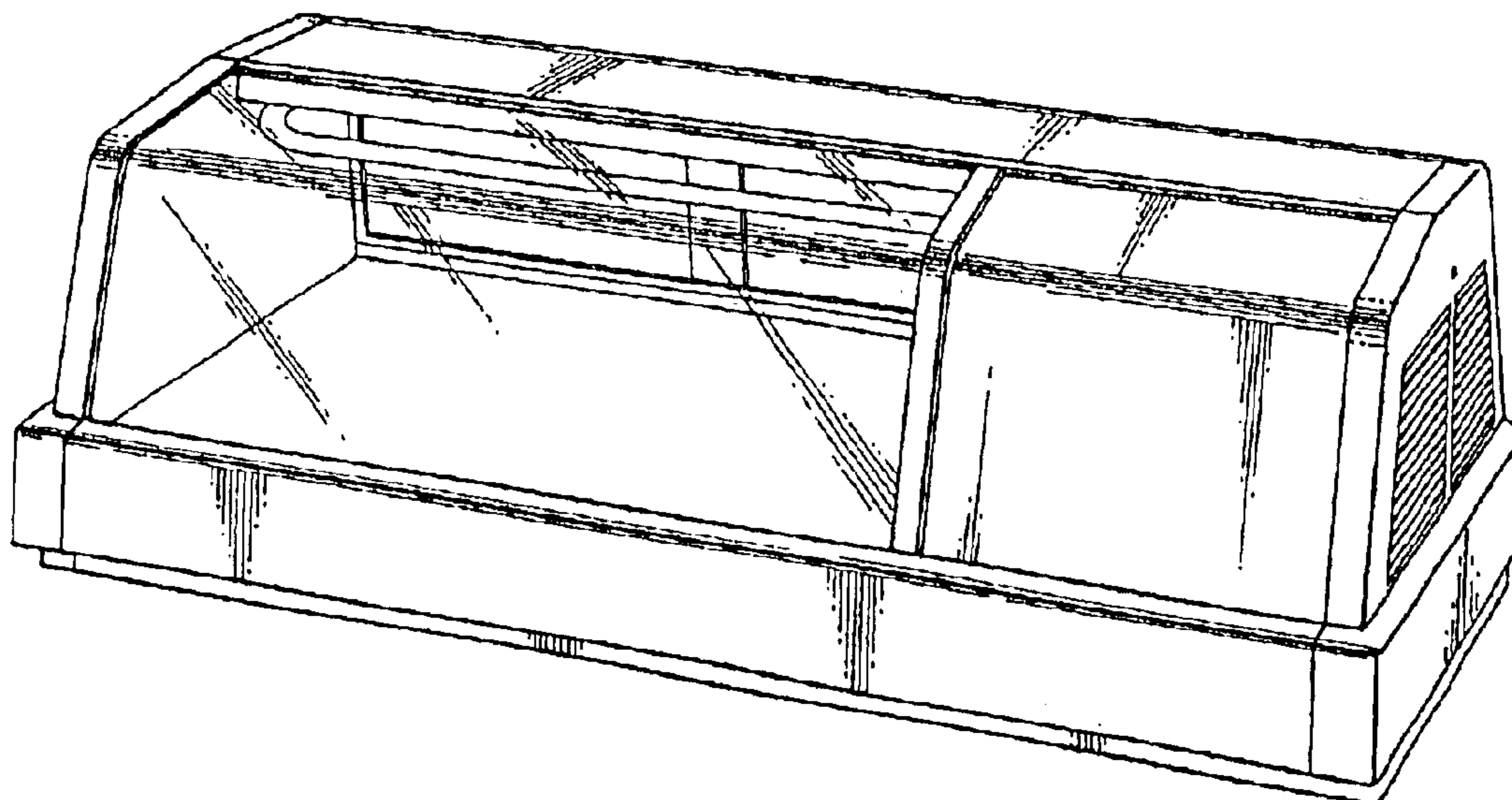

FIG. 1

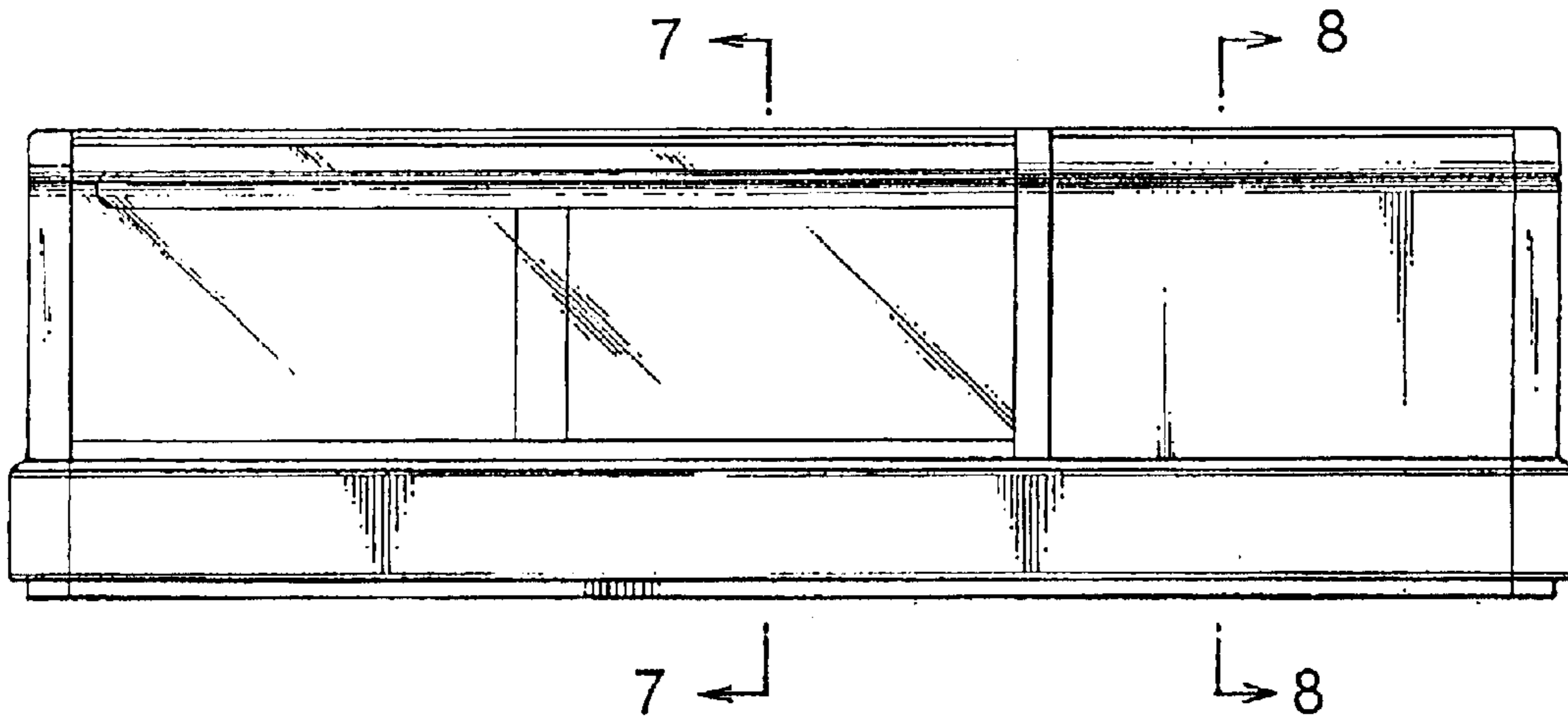

FIG. 2

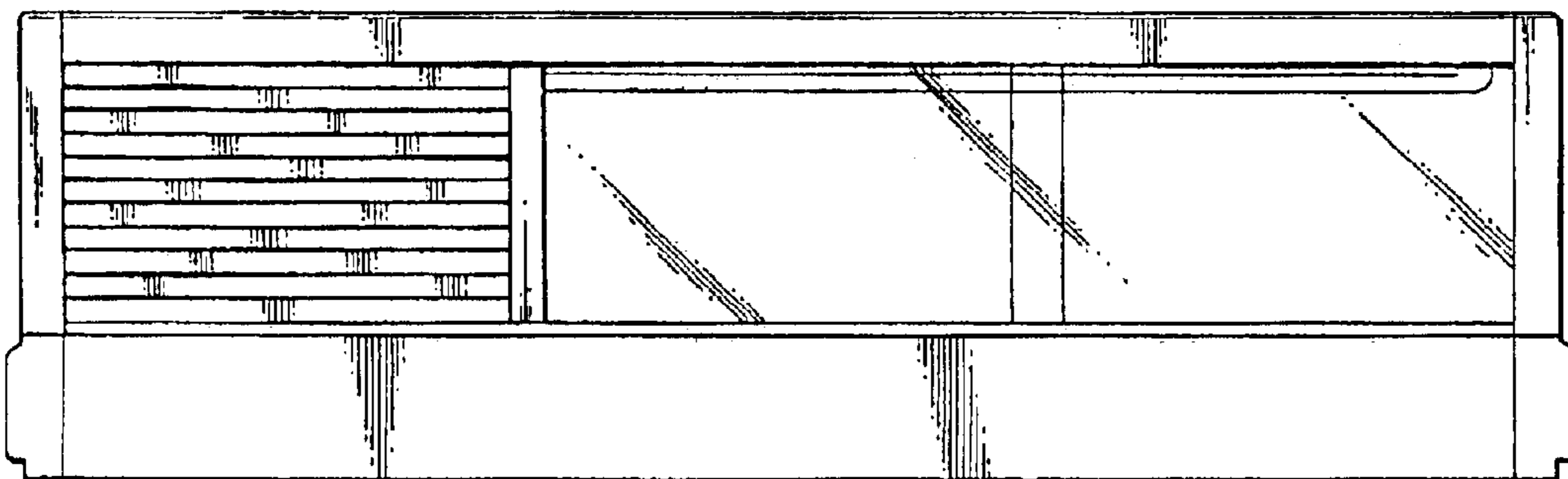

FIG. 3

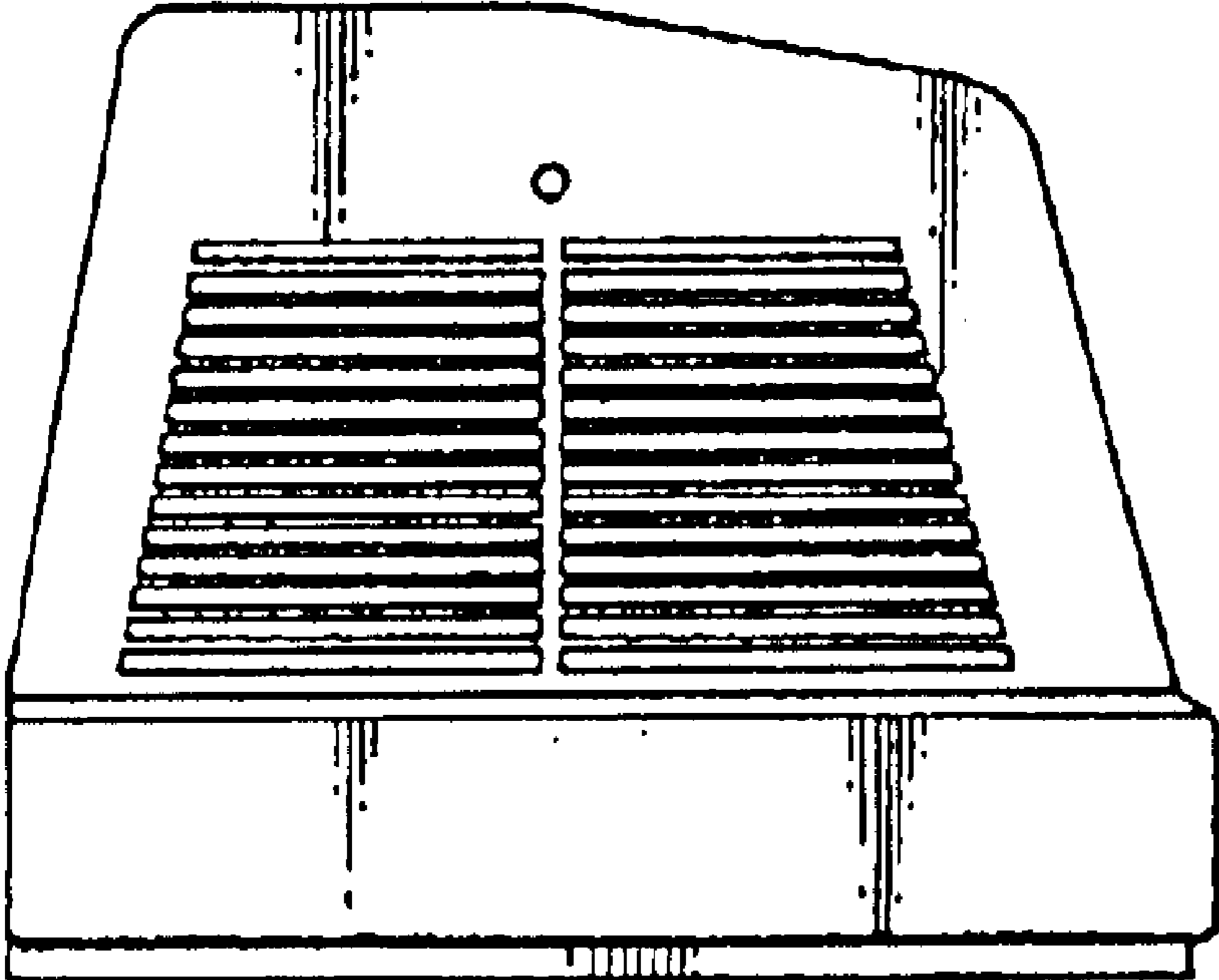

FIG. 4

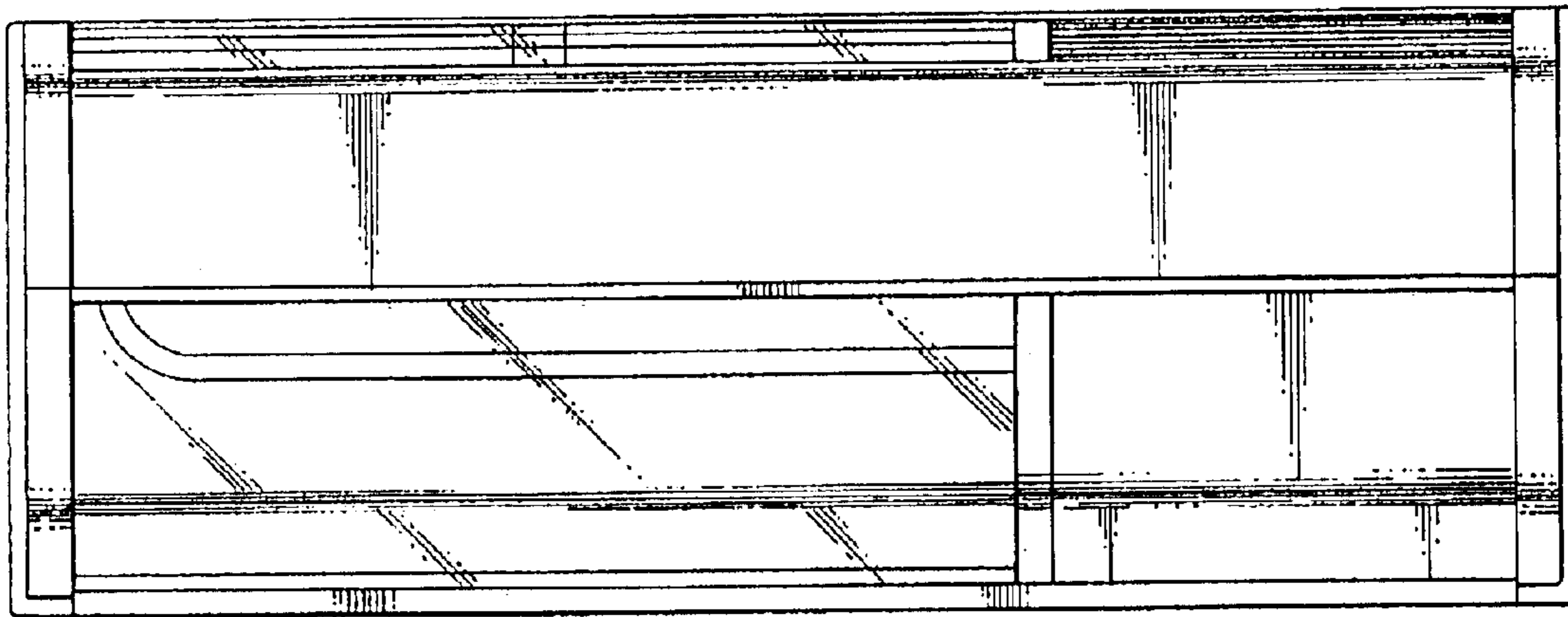

FIG. 5

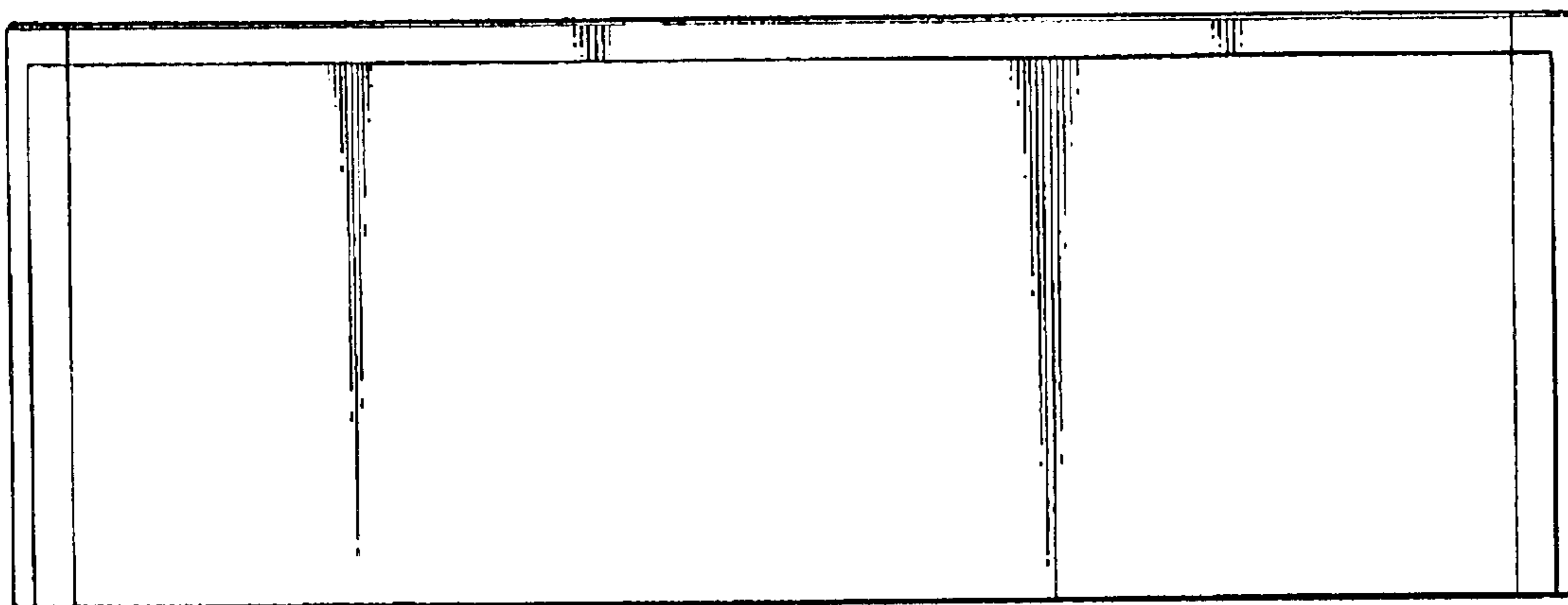

FIG. 6

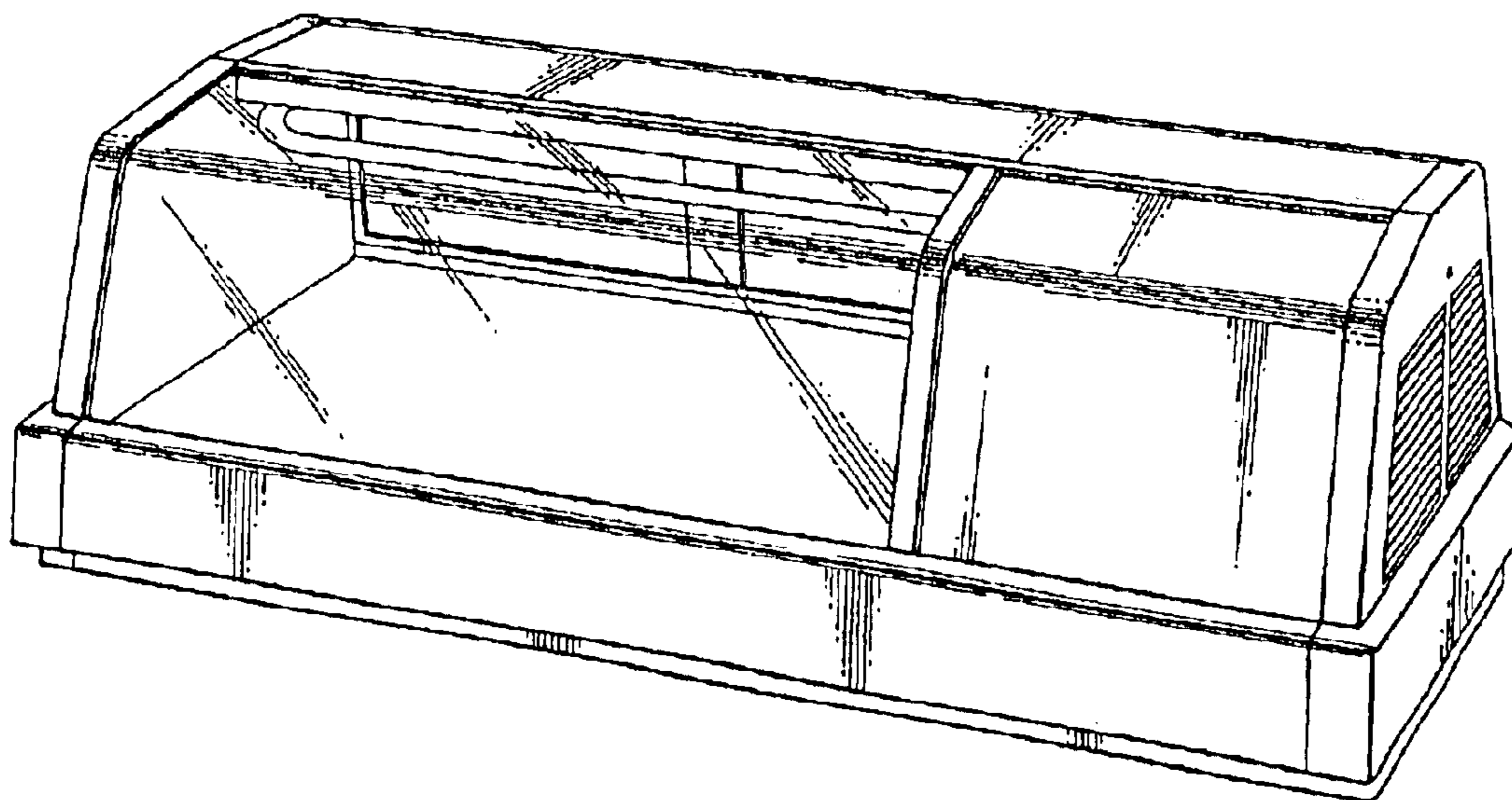

FIG. 7

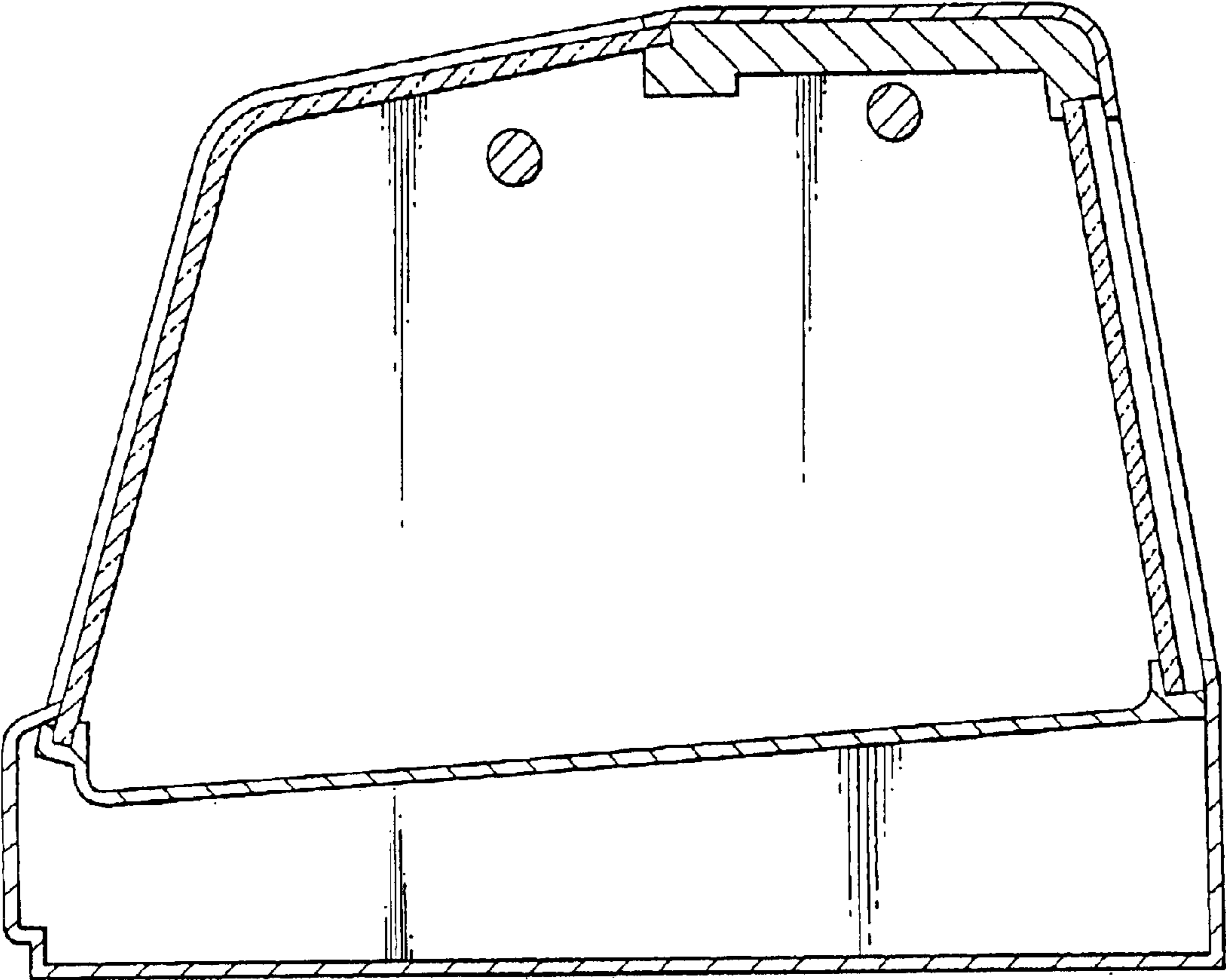

FIG. 8

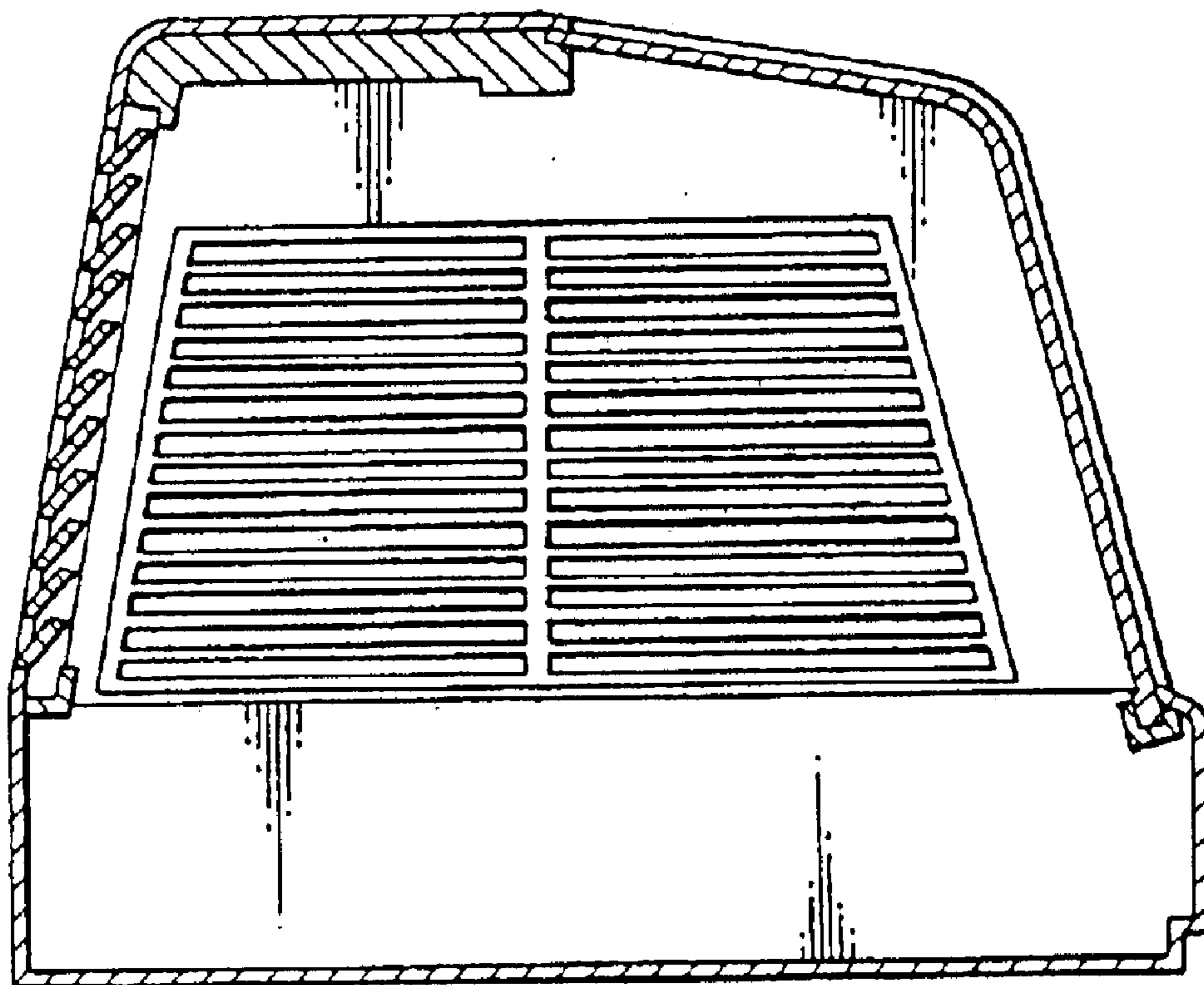

FIG. 9

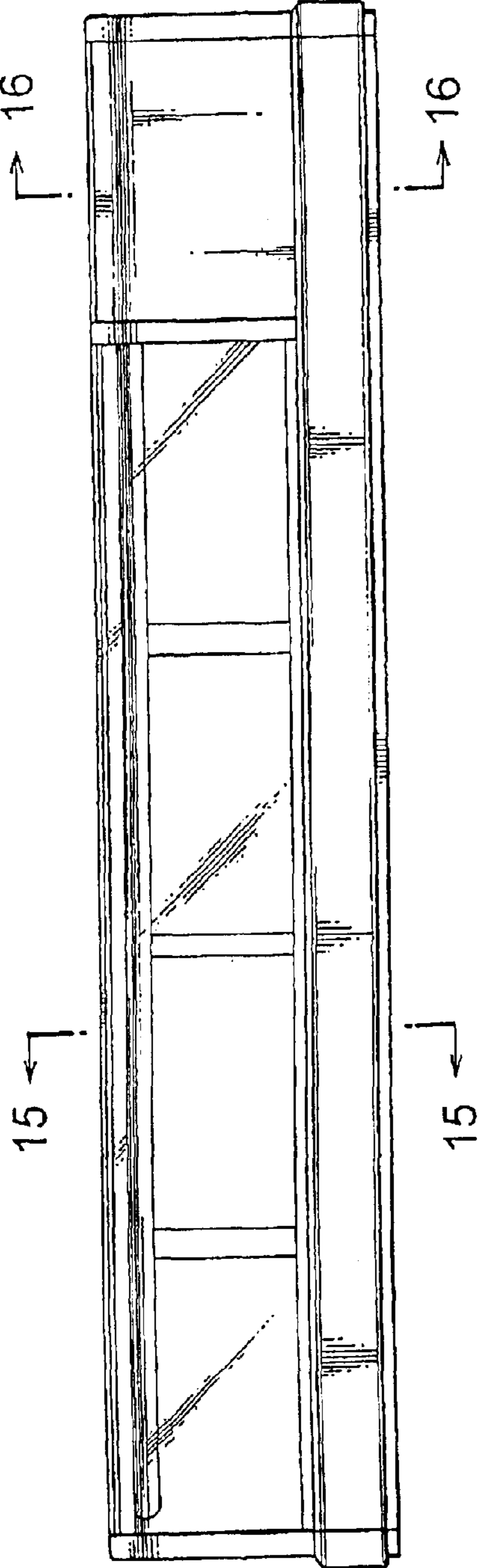

FIG. 10

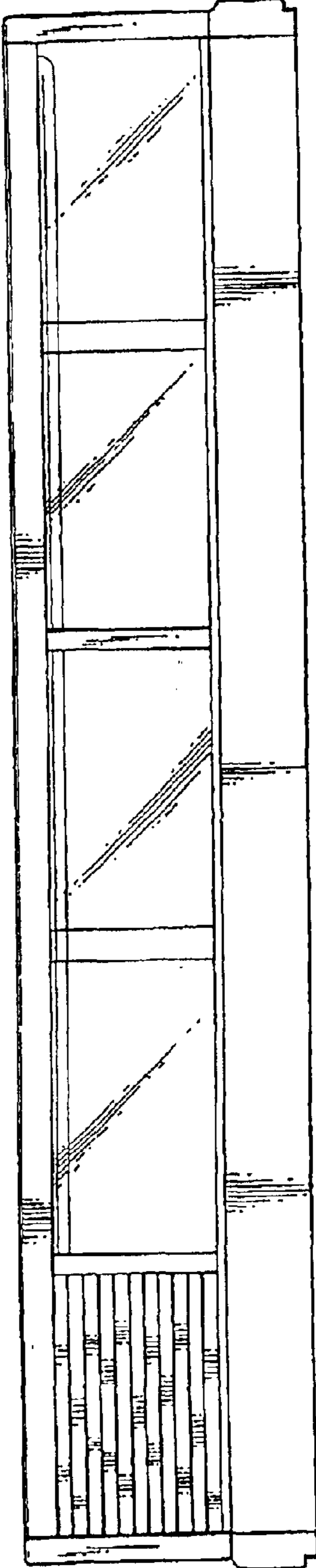

FIG. 11

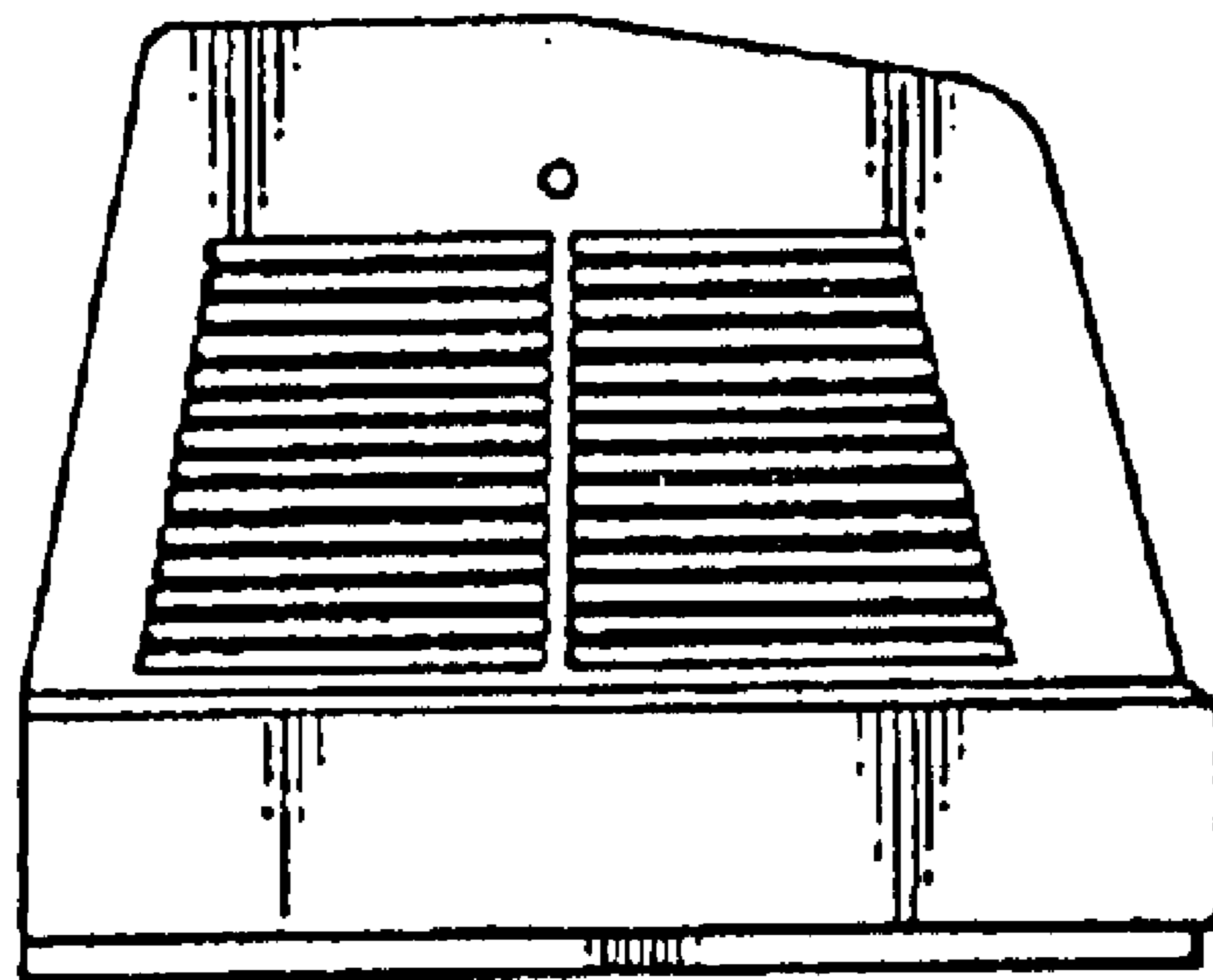

FIG. 12

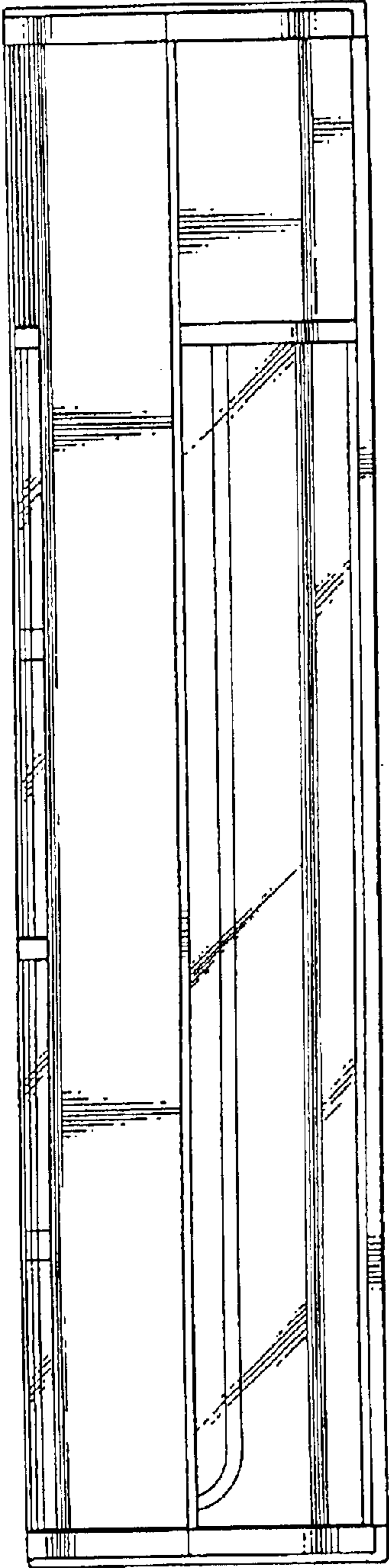

FIG. 13

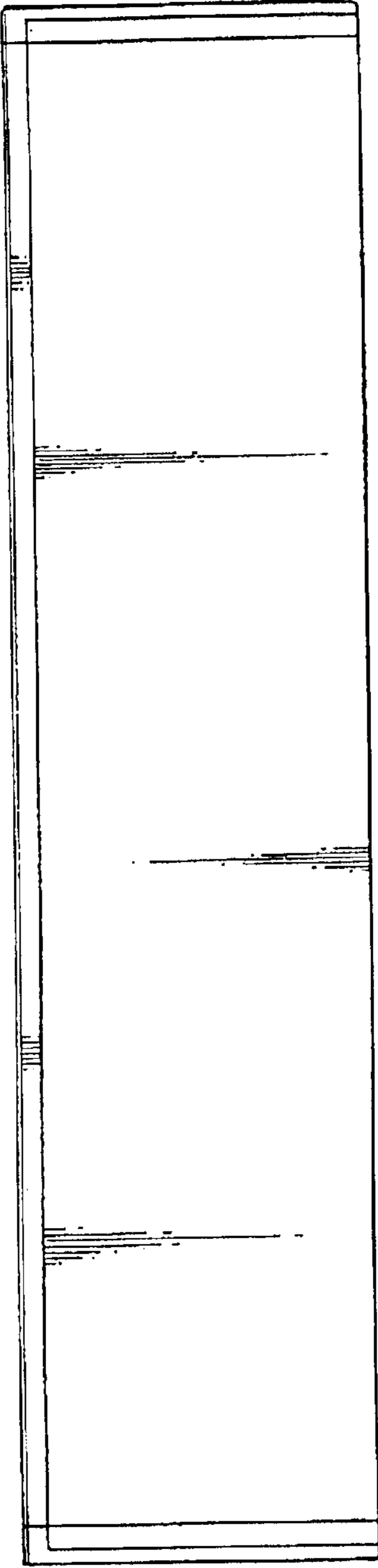

FIG. 14

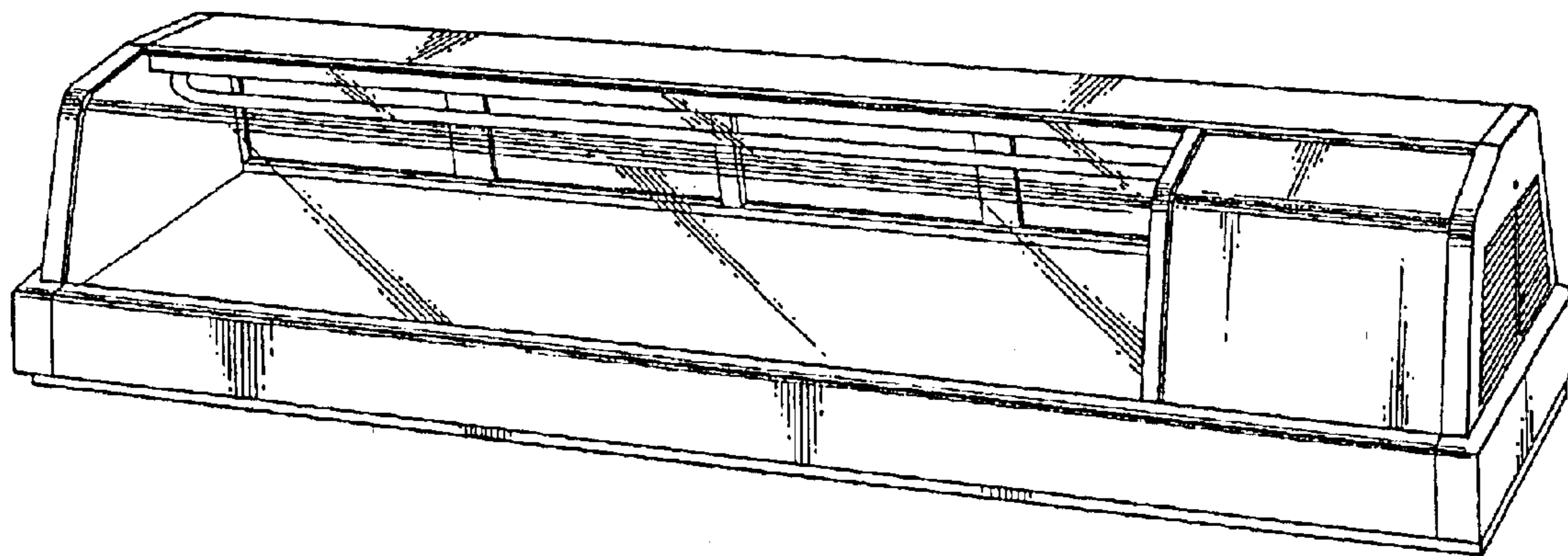

FIG. 15

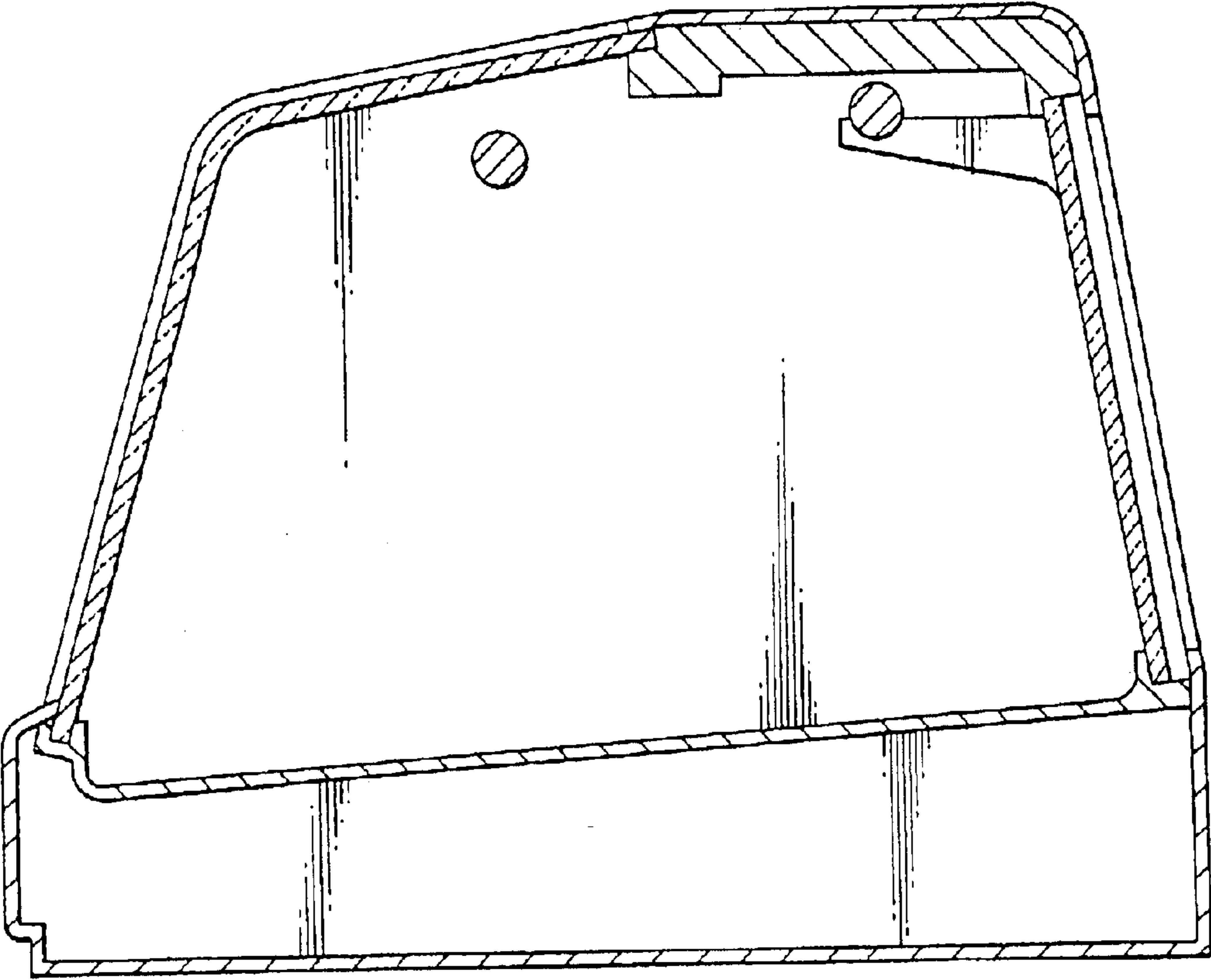

FIG. 16

