

US00D499082S

(12) **United States Design Patent**
Tanaka

(10) **Patent No.:** **US D499,082 S**
(45) **Date of Patent:** **** Nov. 30, 2004**

(54) **COMBINED DISC PLAYER, RADIO RECEIVER AND TAPE RECORDER**

(75) Inventor: **Soichi Tanaka**, Tokyo (JP)

(73) Assignee: **Sony Corporation**, Tokyo (JP)

(**) Term: **14 Years**

(21) Appl. No.: **29/194,940**

(22) Filed: **Dec. 4, 2003**

(51) **LOC (7) Cl.** **14-01**

(52) **U.S. Cl.** **D14/168**

(58) **Field of Search** D14/135-136,
D14/156-157, 160-165, 167-168, 193-198,
188-189, 496; 455/347-351; 369/75.1,
75.2, 77.1, 77.2

(56) **References Cited**

U.S. PATENT DOCUMENTS

D442,572 S	*	5/2001	Chan	D14/162
D442,936 S	*	5/2001	Chan	D14/162
D451,081 S	*	11/2001	Jerome	D14/156
D452,963 S	*	1/2002	Suzuki	D14/168
D456,385 S	*	4/2002	Suzuki	D14/217
D460,747 S	*	7/2002	Zeitman	D14/168
D463,782 S	*	10/2002	Chan	D14/196

OTHER PUBLICATIONS

Web page "Sony eCatalog, CFD-S250," http://www.ecat.sony.co.jp/audio/radio_casestte/products/index.cfm?PD=14600&KM=CFD-S250, (Aug. 2003).

Web page "Sony eCatalog, CFD-S100," http://www.ecat.sony.co.jp/audio/radio_casestte/products/index.cfm?PD=8598&KM=CFD-S100, (Aug. 2003).

Web page "Sony eCatalog, CFD-S20CP," http://www.ecat.sony.co.jp/audio/radio_casestte/products/index.cfm?PD=8600&KM=CFD-S20CP, (Aug. 2003).

Web page "Sony eCatalog, CFD-S26," http://www.ecat.sony.co.jp/audio/radio_casestte/products/index.cfm?PD=321&KM=CFD-S26, (Aug. 2003).

* cited by examiner

Primary Examiner—Nanda Bondade

(74) *Attorney, Agent, or Firm*—Rader, Fishman & Grauer PLLC

(57) **CLAIM**

The ornamental design for a combined disc player, radio receiver and tape recorder, as shown and described.

DESCRIPTION

FIG. 1 is a perspective view of a first embodiment of a combined disc player, radio receiver and tape recorder showing my new design;

FIG. 2 is a front elevational view thereof;

FIG. 3 is a rear elevational view thereof;

FIG. 4 is a left side elevational view thereof;

FIG. 5 is a right side elevational view thereof;

FIG. 6 is a top plan view thereof;

FIG. 7 is a bottom plan view thereof;

FIG. 8 is a perspective view of a second embodiment of a combined disc player, radio receiver and tape recorder showing my new design;

FIG. 9 is a front elevational view thereof;

FIG. 10 is a rear elevational view thereof;

FIG. 11 is a left side elevational view thereof;

FIG. 12 is a right side elevational view thereof;

FIG. 13 is a top plan view thereof; and,

FIG. 14 is a bottom plan view thereof.

Portions in broken lines are for illustrative purpose only and form no part of the claimed design.

1 Claim, 8 Drawing Sheets

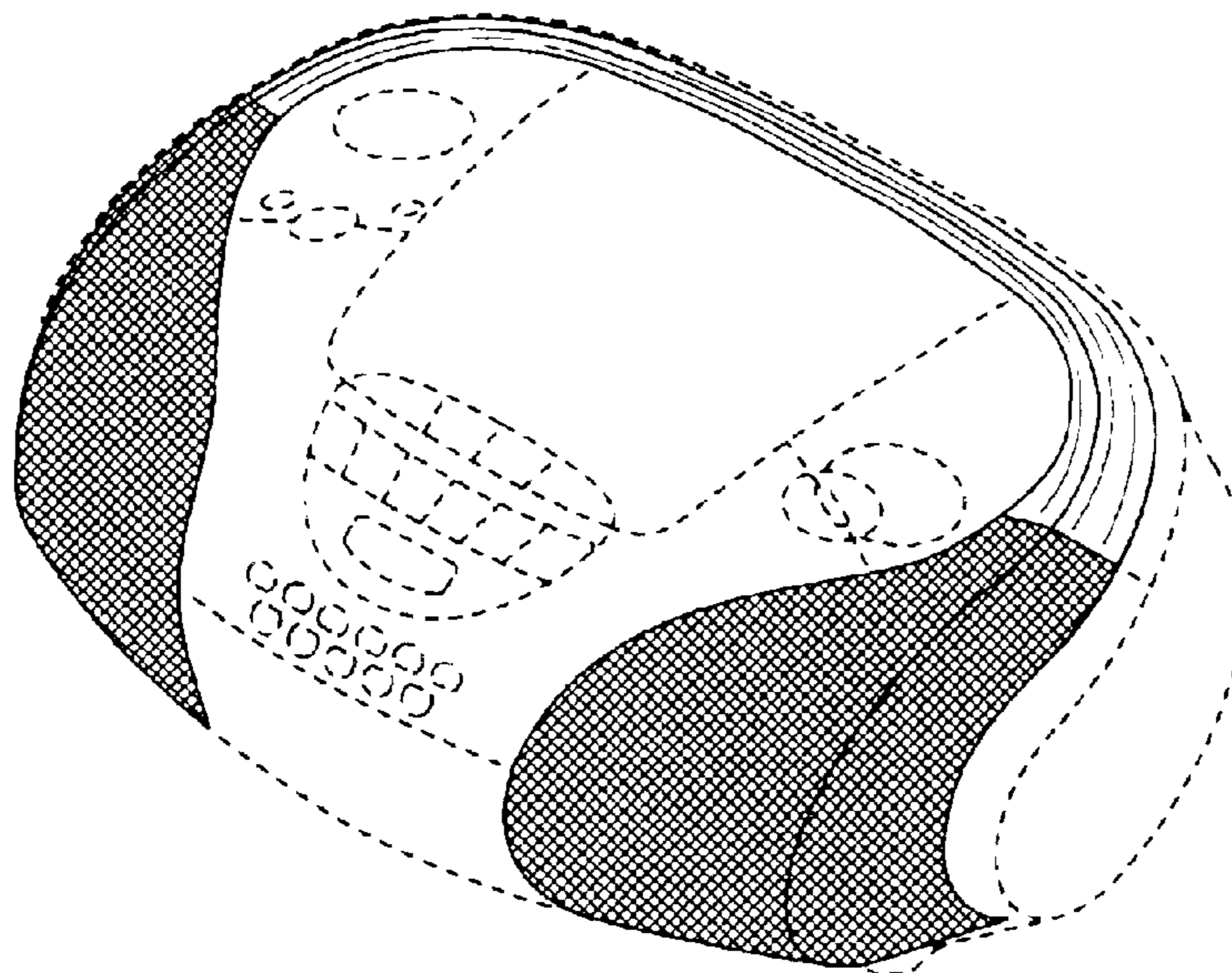

Fig. 1

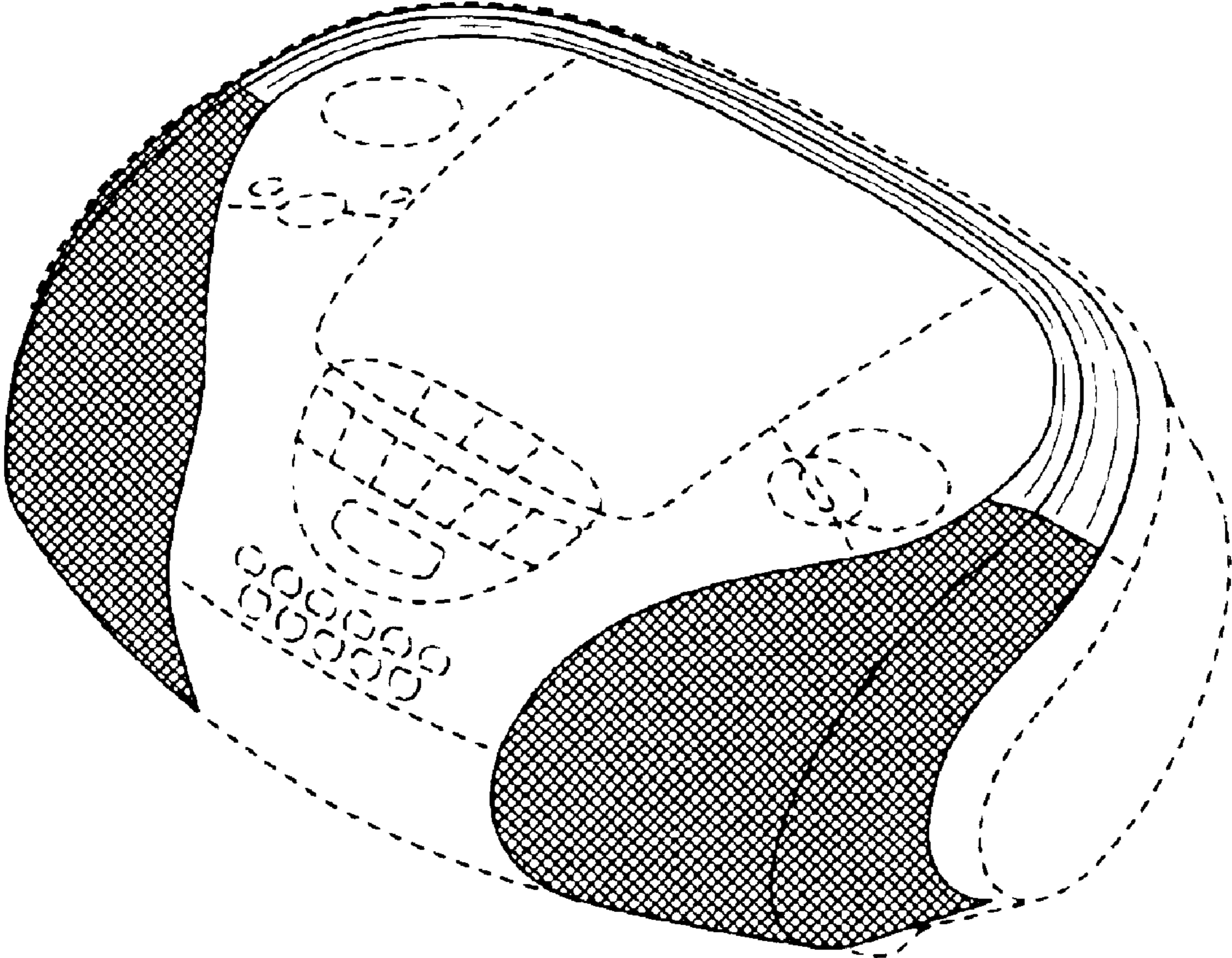

Fig.2

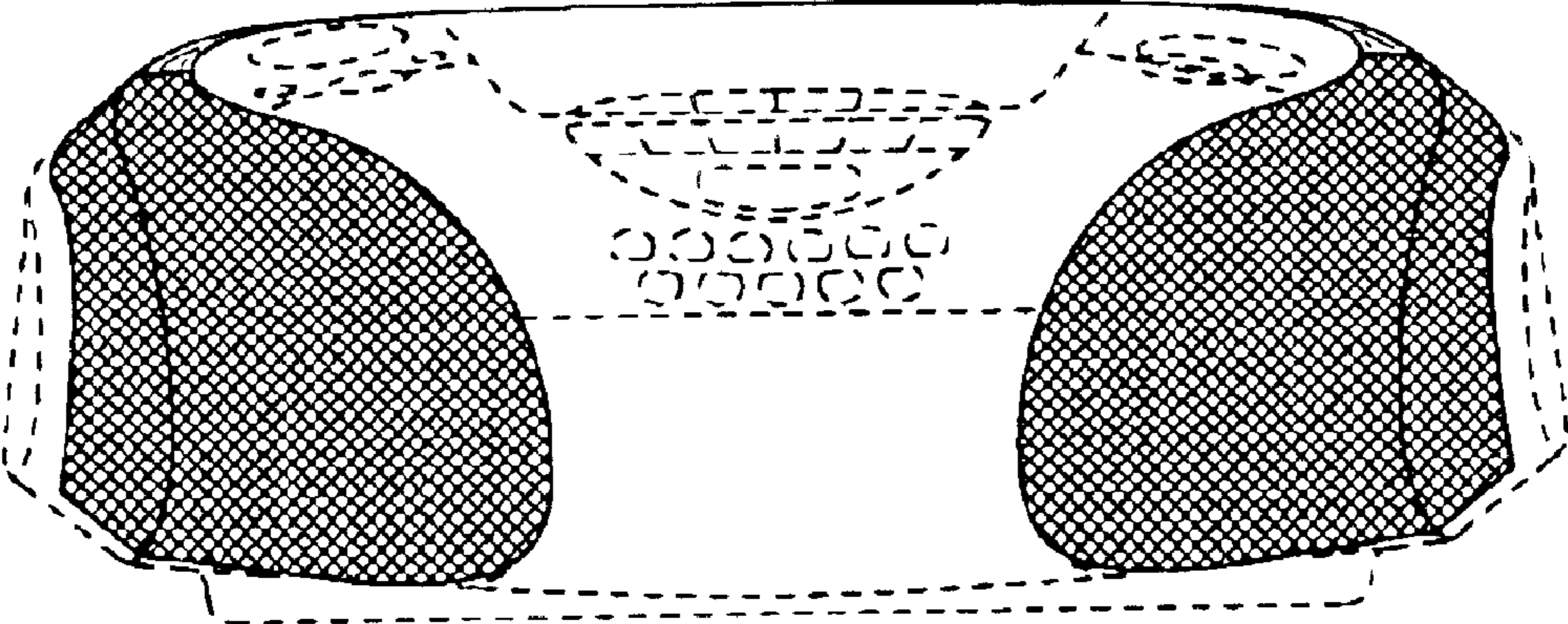

Fig.3

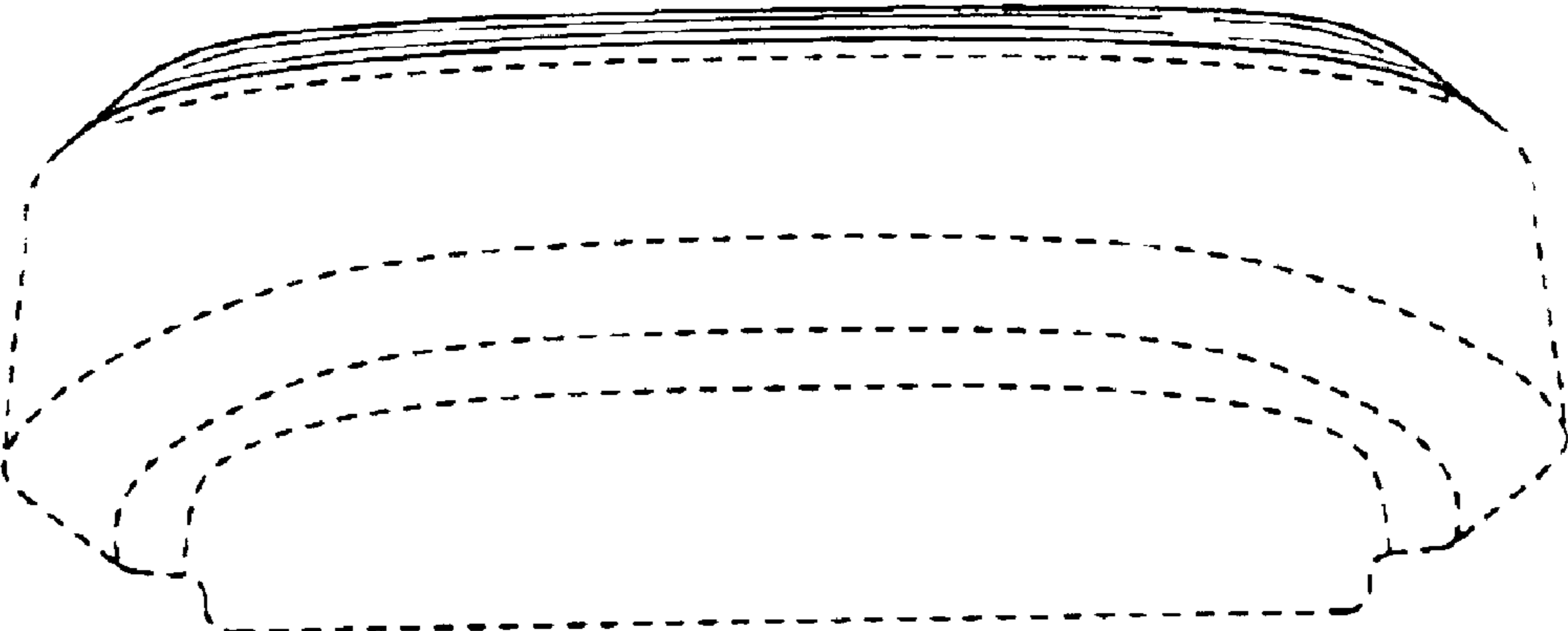

Fig.4

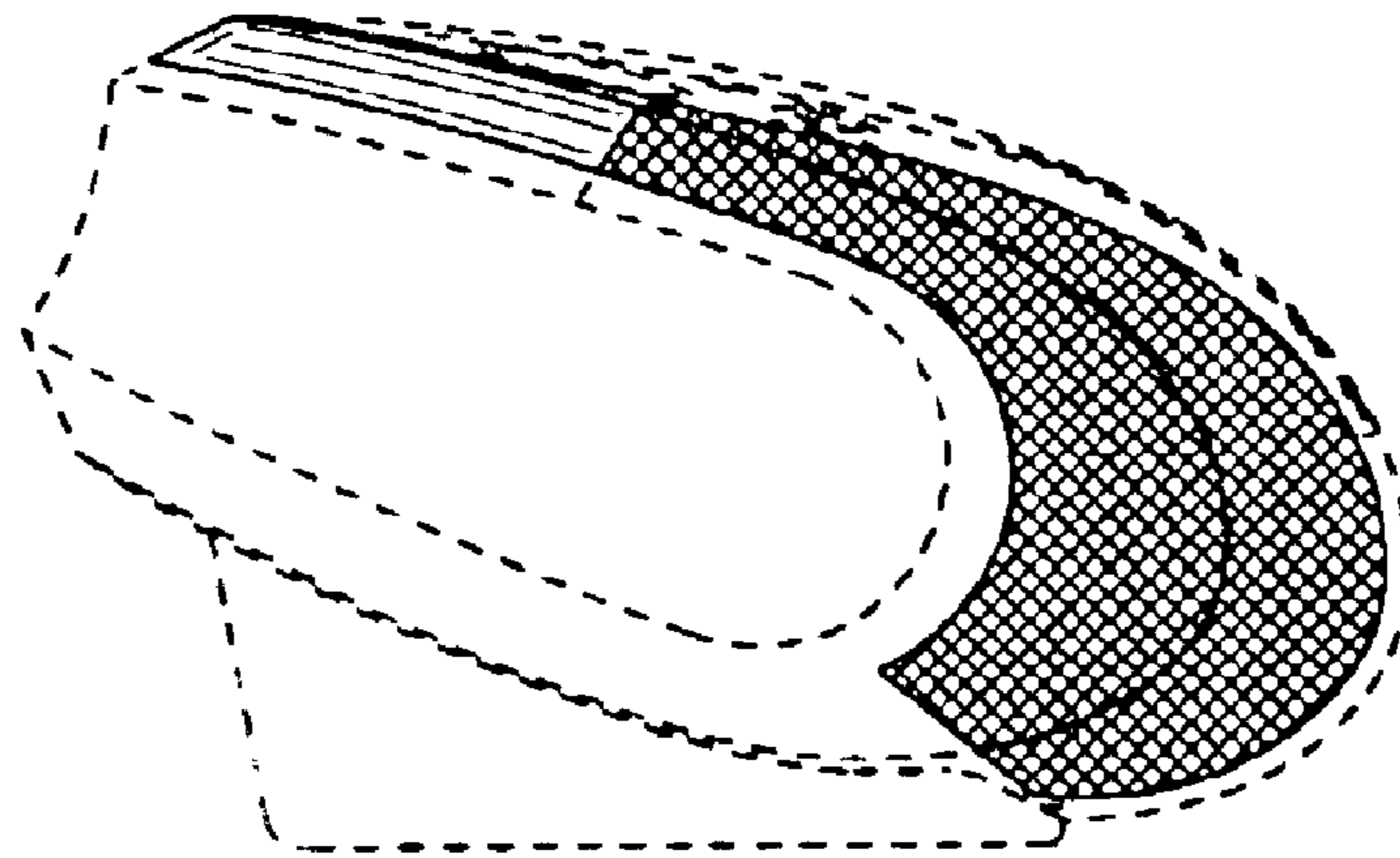

Fig.5

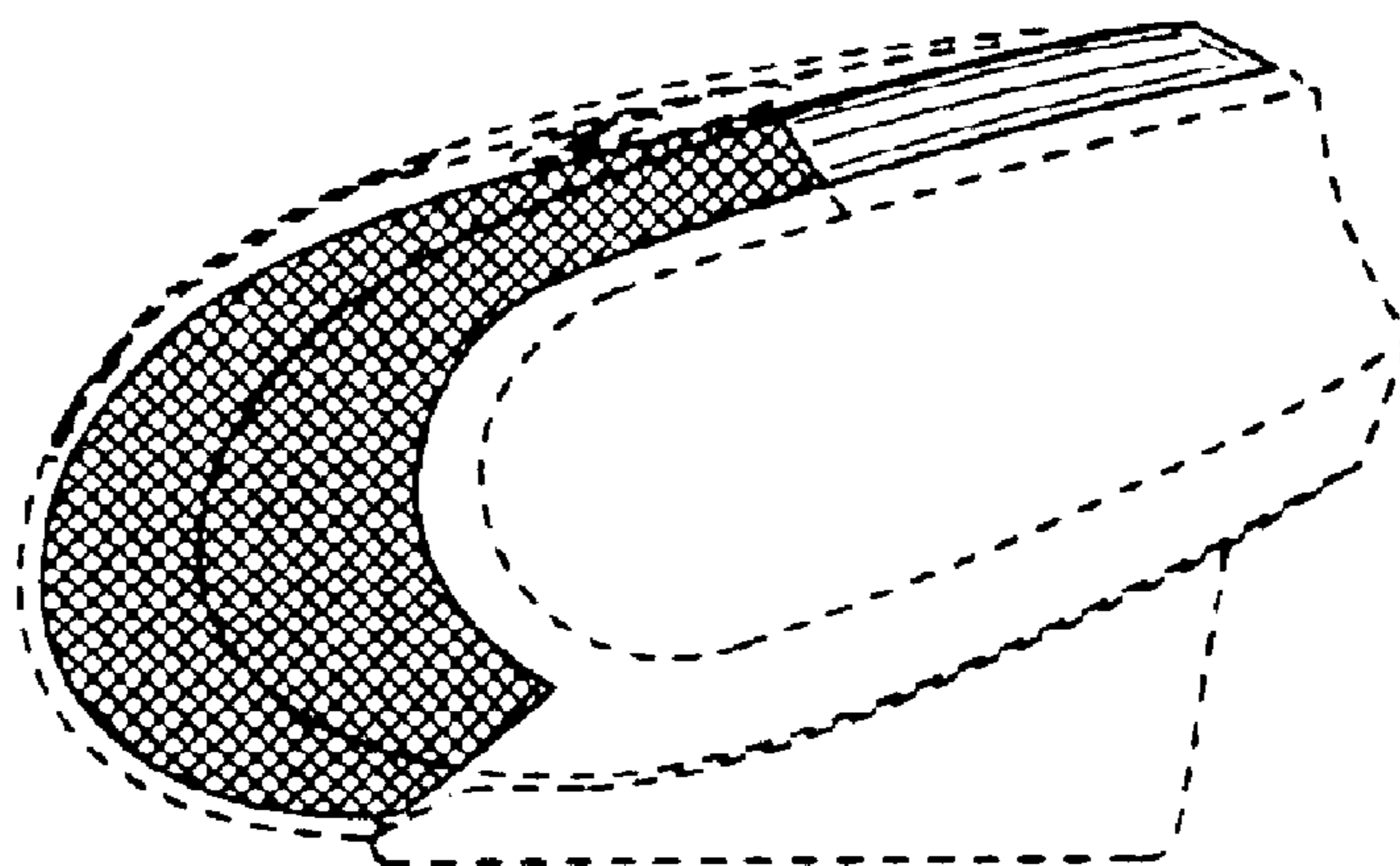

Fig.6

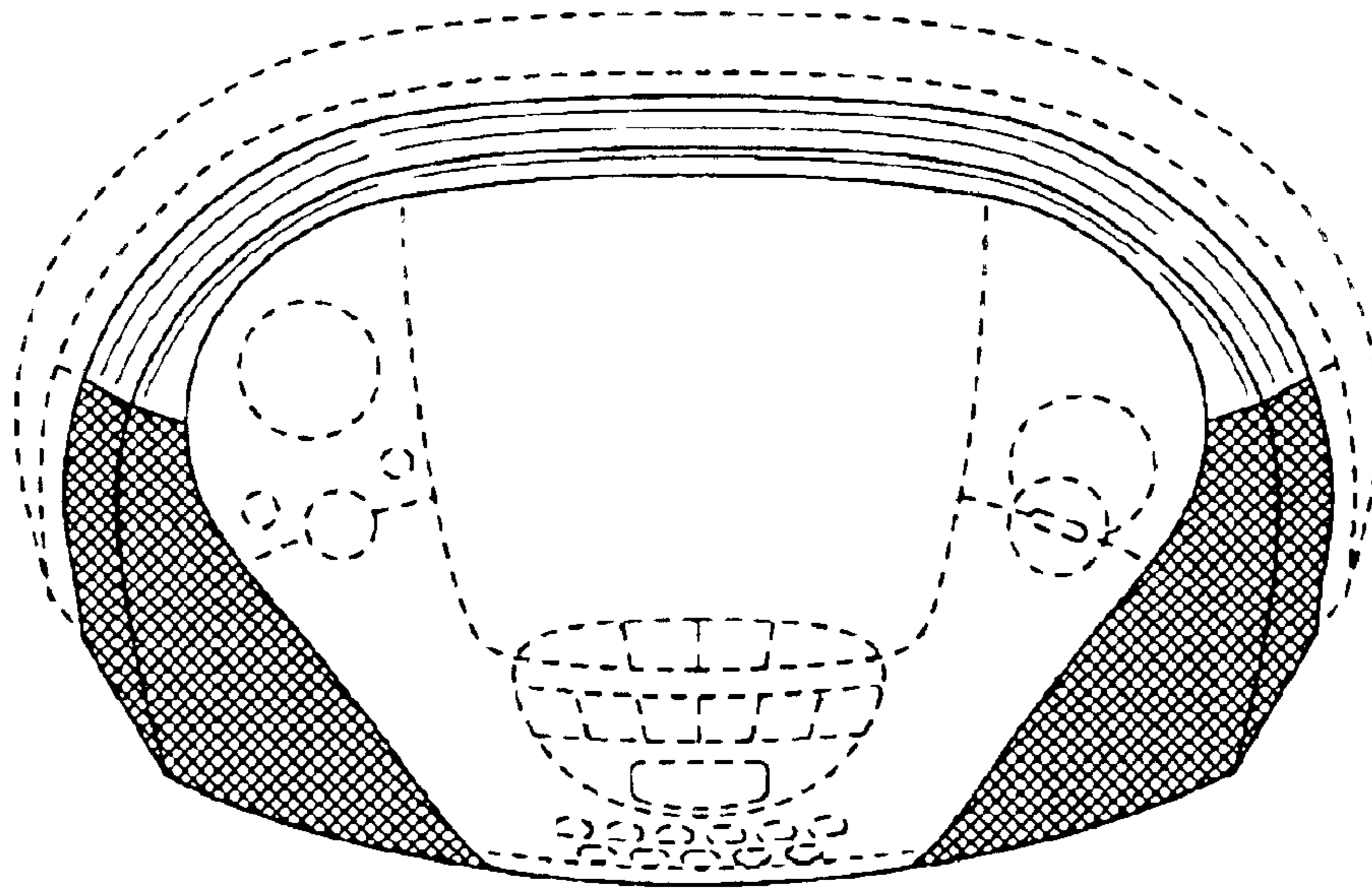

Fig.7

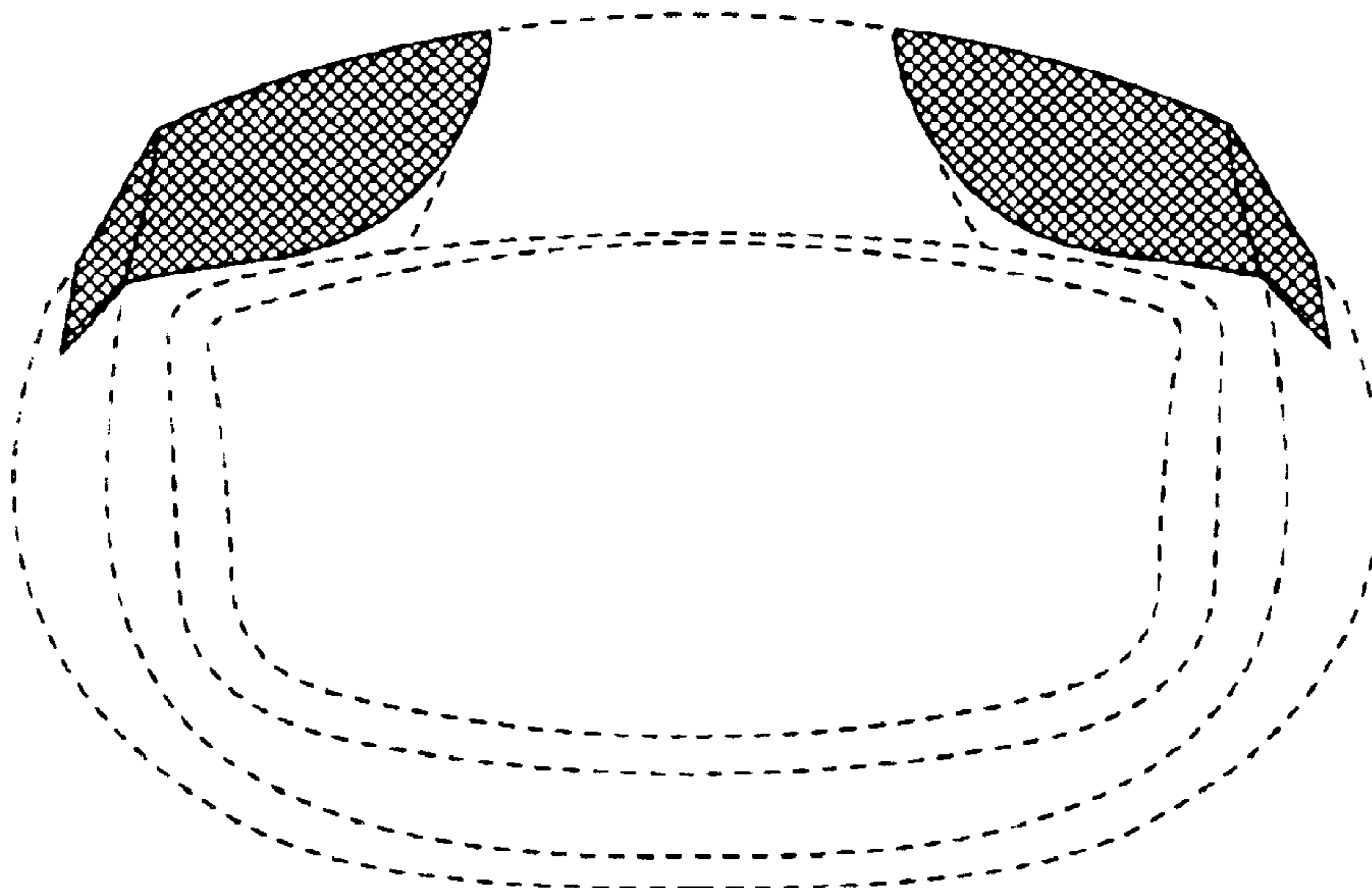

Fig.8

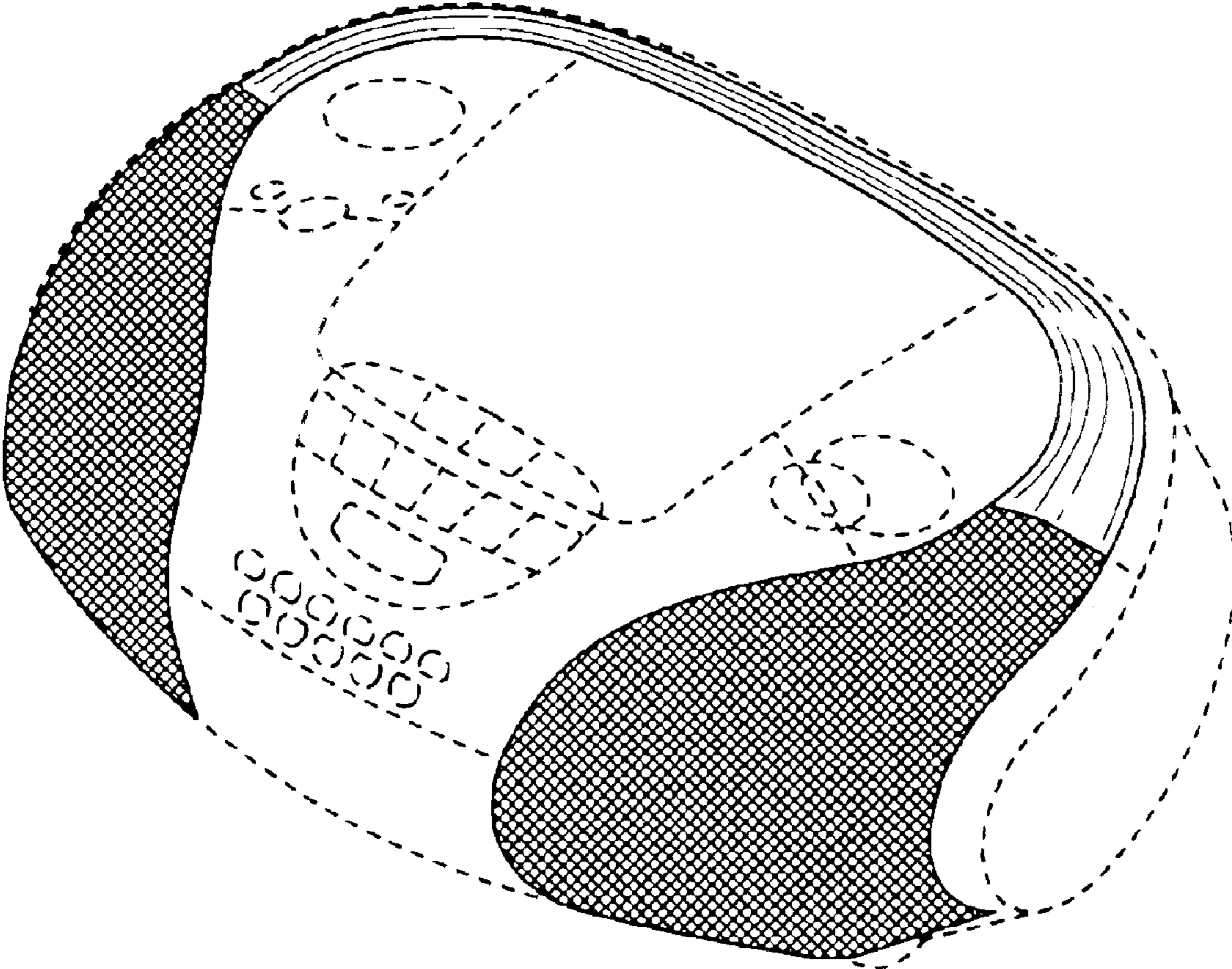

Fig.9

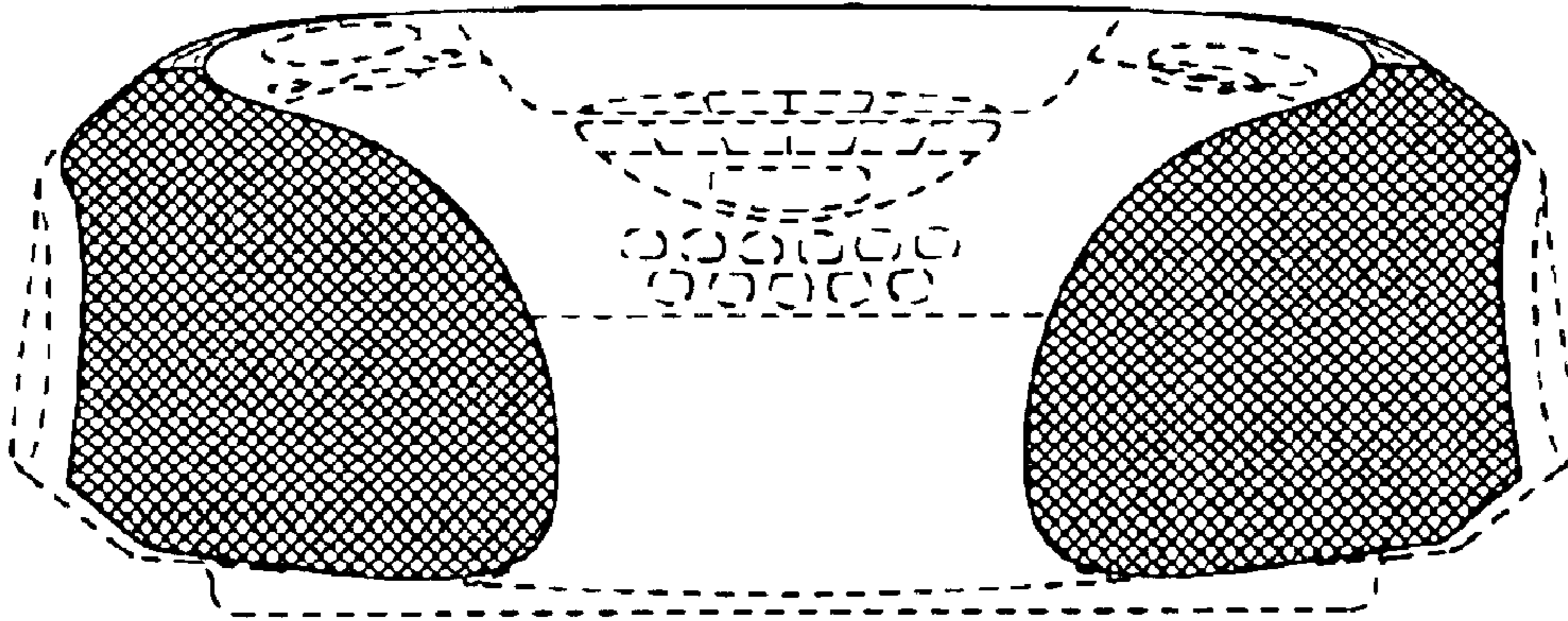

Fig.10

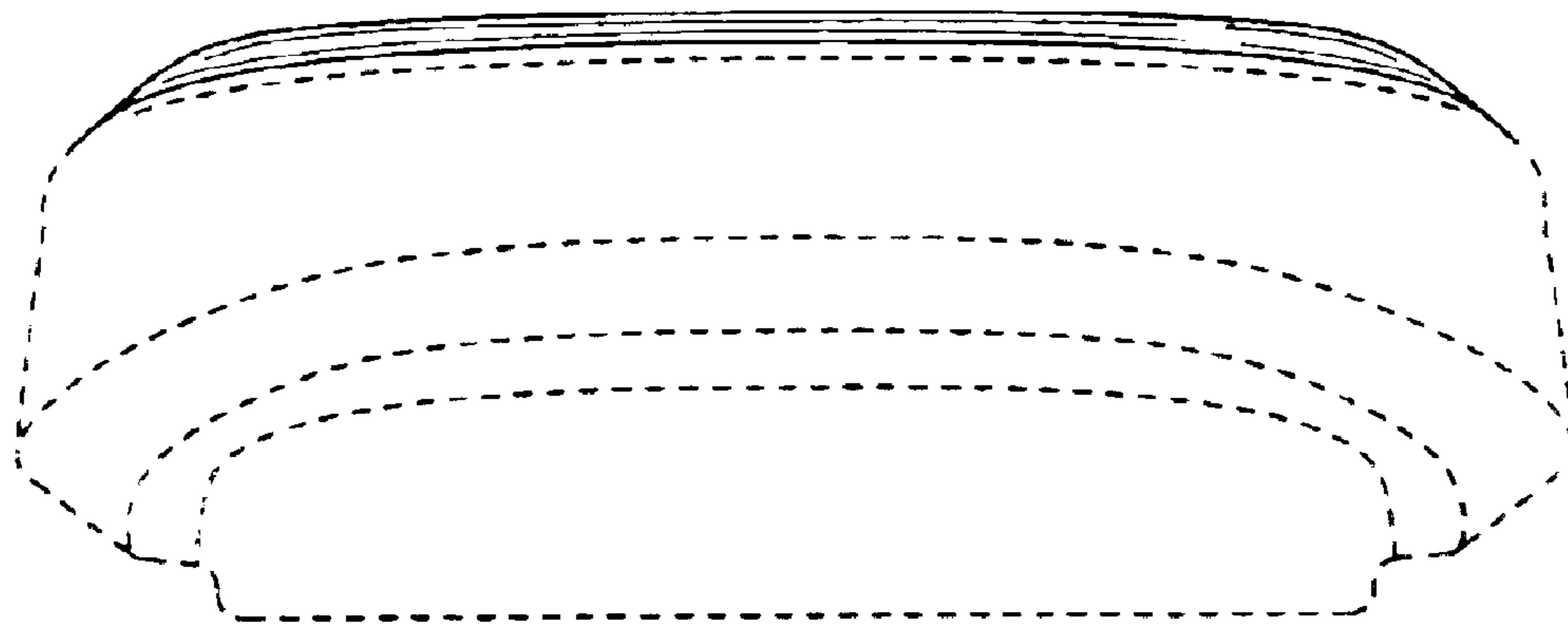

Fig.11

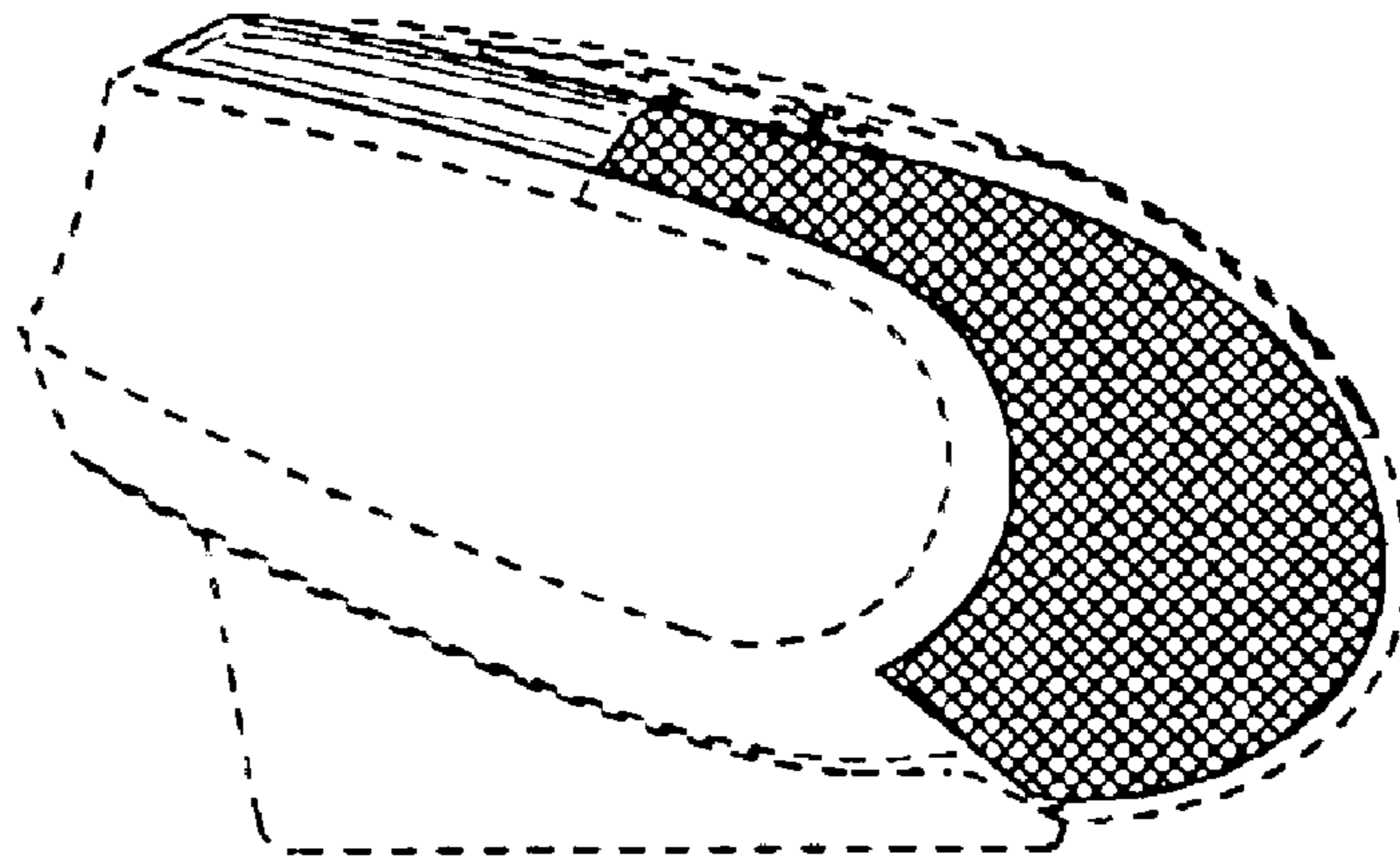

Fig.12

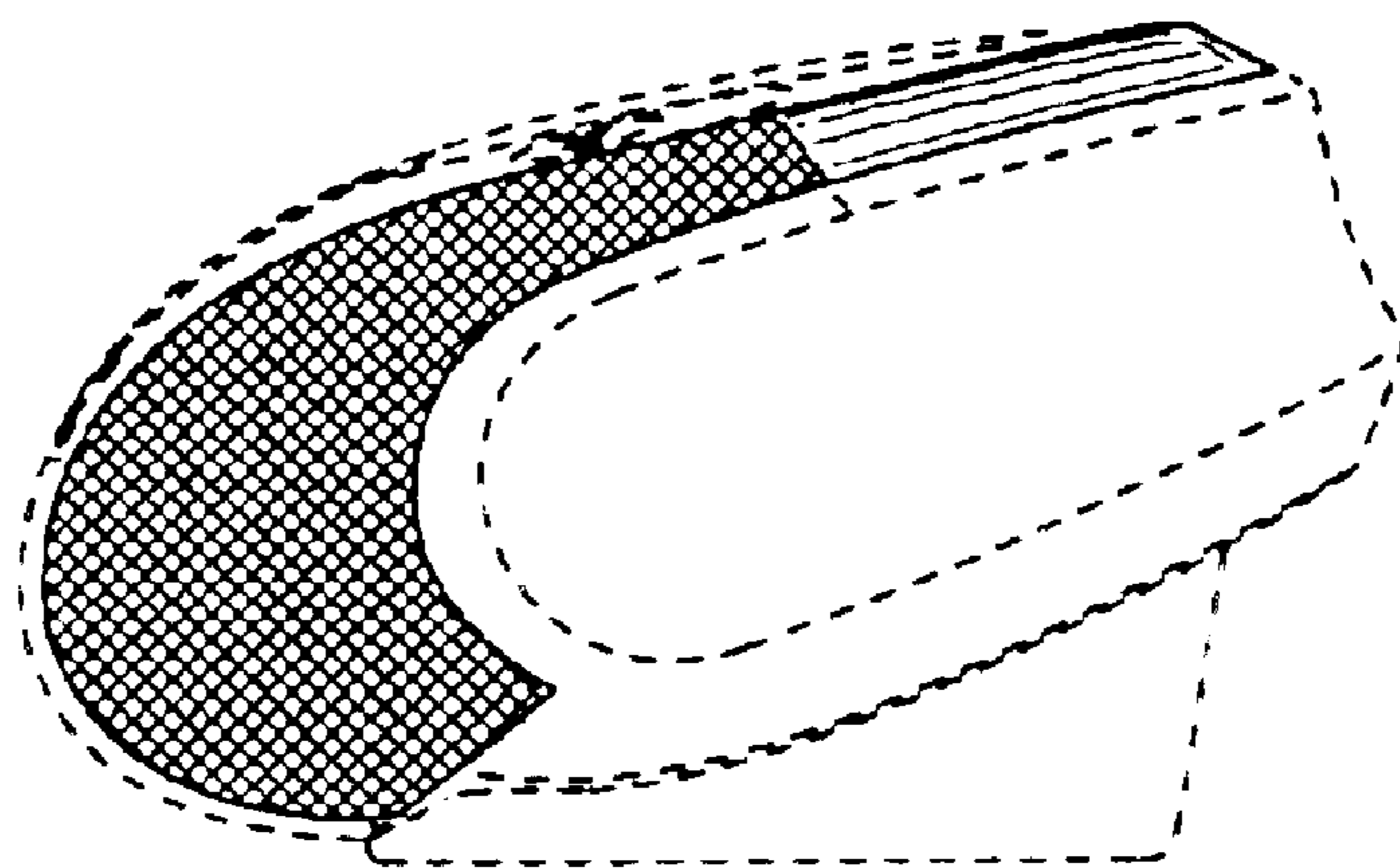

Fig.13

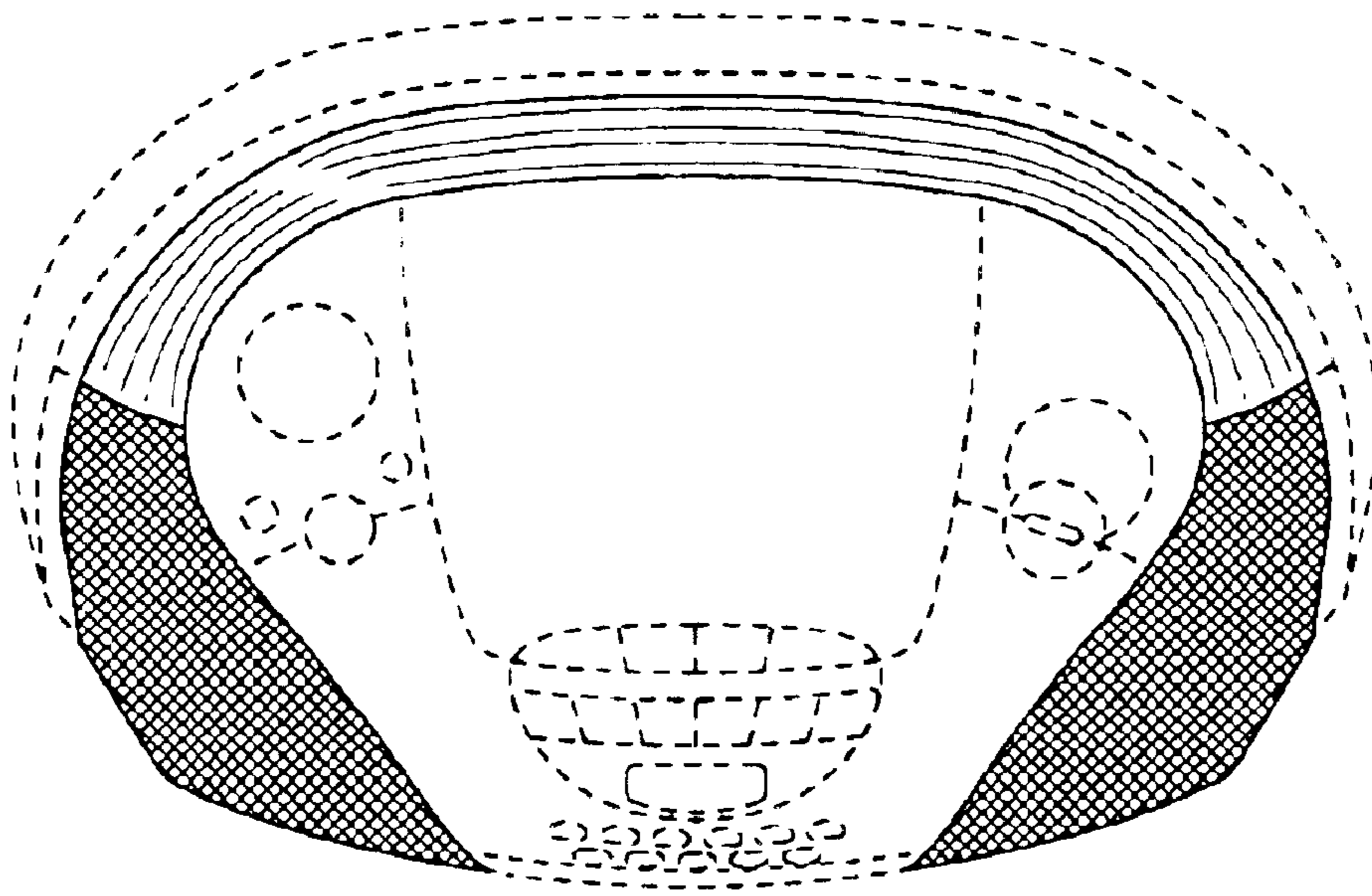

Fig.14

