

US00D499018S

(12) **United States Design Patent**  
**Dato et al.**

(10) **Patent No.: US D499,018 S**

(45) **Date of Patent: \*\* Nov. 30, 2004**

(54) **RIBBON DISPENSER**

D478,810 S \* 8/2003 Wilson ..... D9/341  
D480,301 S \* 10/2003 Pratt ..... D9/415

(76) Inventors: **Kim J. Dato**, 1818 Huntington St.,  
Huntington Beach, CA (US) 92648;  
**James E. Dato**, 1818 Huntington St.,  
Huntington Beach, CA (US) 92648

\* cited by examiner

*Primary Examiner*—Prabhakar Deshmukh  
(74) *Attorney, Agent, or Firm*—Gazdzinski & Associates

(\*\*) Term: **14 Years**

(57) **CLAIM**

(21) Appl. No.: **29/191,511**

The ornamental design for ribbon dispenser, as shown and described.

(22) Filed: **Oct. 7, 2003**

**DESCRIPTION**

(51) **LOC (7) Cl.** ..... **09-03**

(52) **U.S. Cl.** ..... **D9/415**

(58) **Field of Search** ..... D9/415, 418, 341,  
D9/346, 457, 425; 206/461–471, 495, 806,  
769–773, 775–778, 388, 49, 390, 391, 392,  
53; 242/160.1, 160.2, 570, 600, 159

FIG. 1 is a perspective view of a first embodiment of a ribbon dispenser, showing our new design; FIG. 2 is a top elevational view thereof; FIG. 3 is a bottom elevational view thereof; FIG. 4 is a front elevational view thereof; FIG. 5 is a side elevational view thereof; FIG. 6 is a top elevational view of a second embodiment of a ribbon dispenser, showing our new design; FIG. 7 is a bottom elevational view thereof; FIG. 8 is a front elevational view thereof; FIG. 9 is a side elevational view thereof; FIG. 10 is a top elevational view of a third embodiment of a ribbon dispenser, showing our new design; FIG. 11 is a bottom elevational view thereof; FIG. 12 is a front elevational view thereof; and, FIG. 13 is a side elevational view thereof.

(56) **References Cited**

**U.S. PATENT DOCUMENTS**

2,312,532 A \* 3/1943 Engstrom ..... 434/98  
3,288,280 A \* 11/1966 Bostrom ..... 206/461  
4,195,739 A \* 4/1980 Sweet, III ..... 211/113  
D324,074 S \* 2/1992 DeJaynes ..... D19/69  
5,209,352 A \* 5/1993 Light et al. .... 206/391  
5,816,408 A \* 10/1998 Indelicato ..... 206/581  
D423,344 S \* 4/2000 Kumakura et al. .... D9/415  
6,364,115 B1 \* 4/2002 Casanova et al. .... 206/471  
6,427,841 B2 \* 8/2002 Wani et al. .... 206/705

**1 Claim, 10 Drawing Sheets**

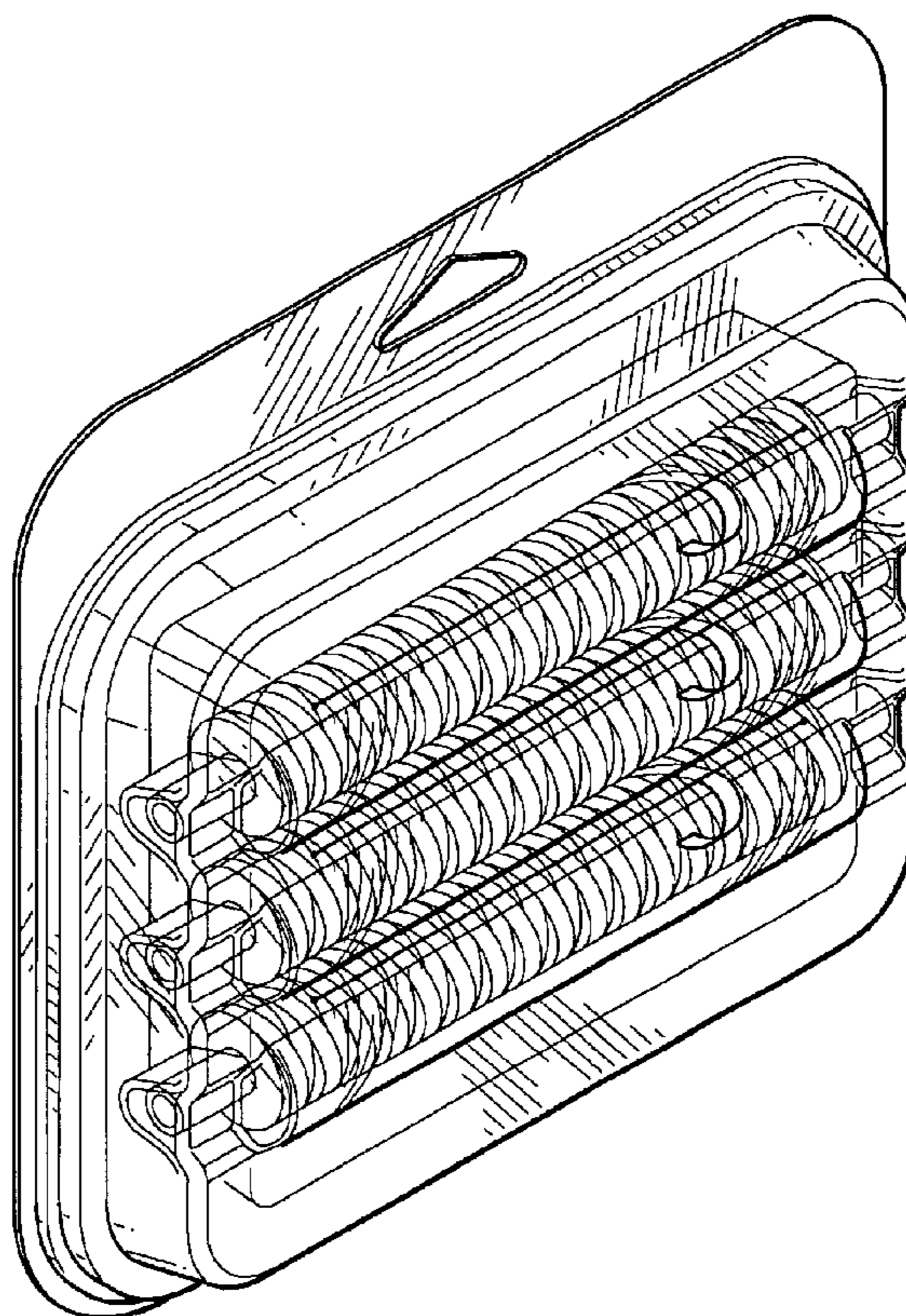

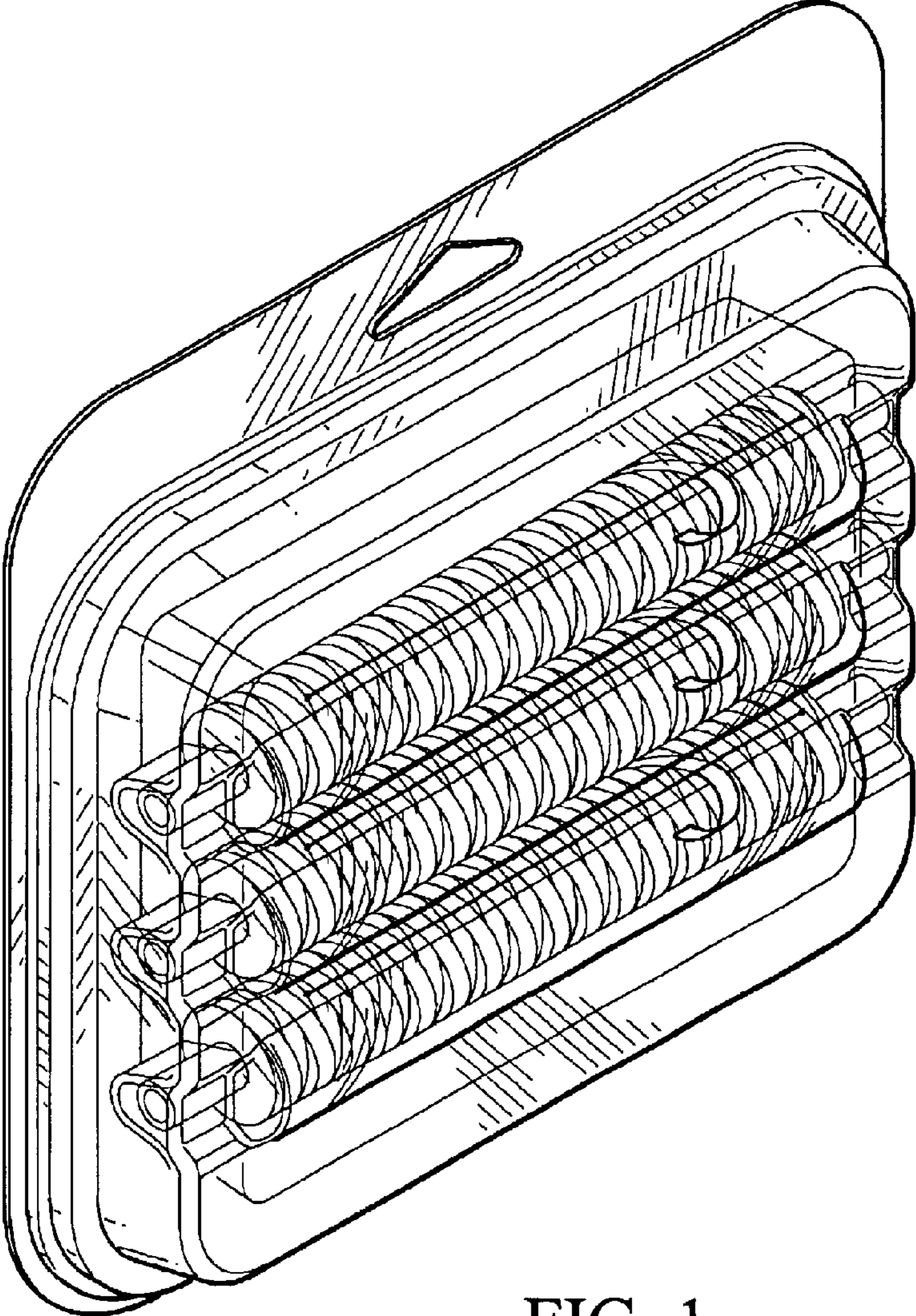

FIG. 1

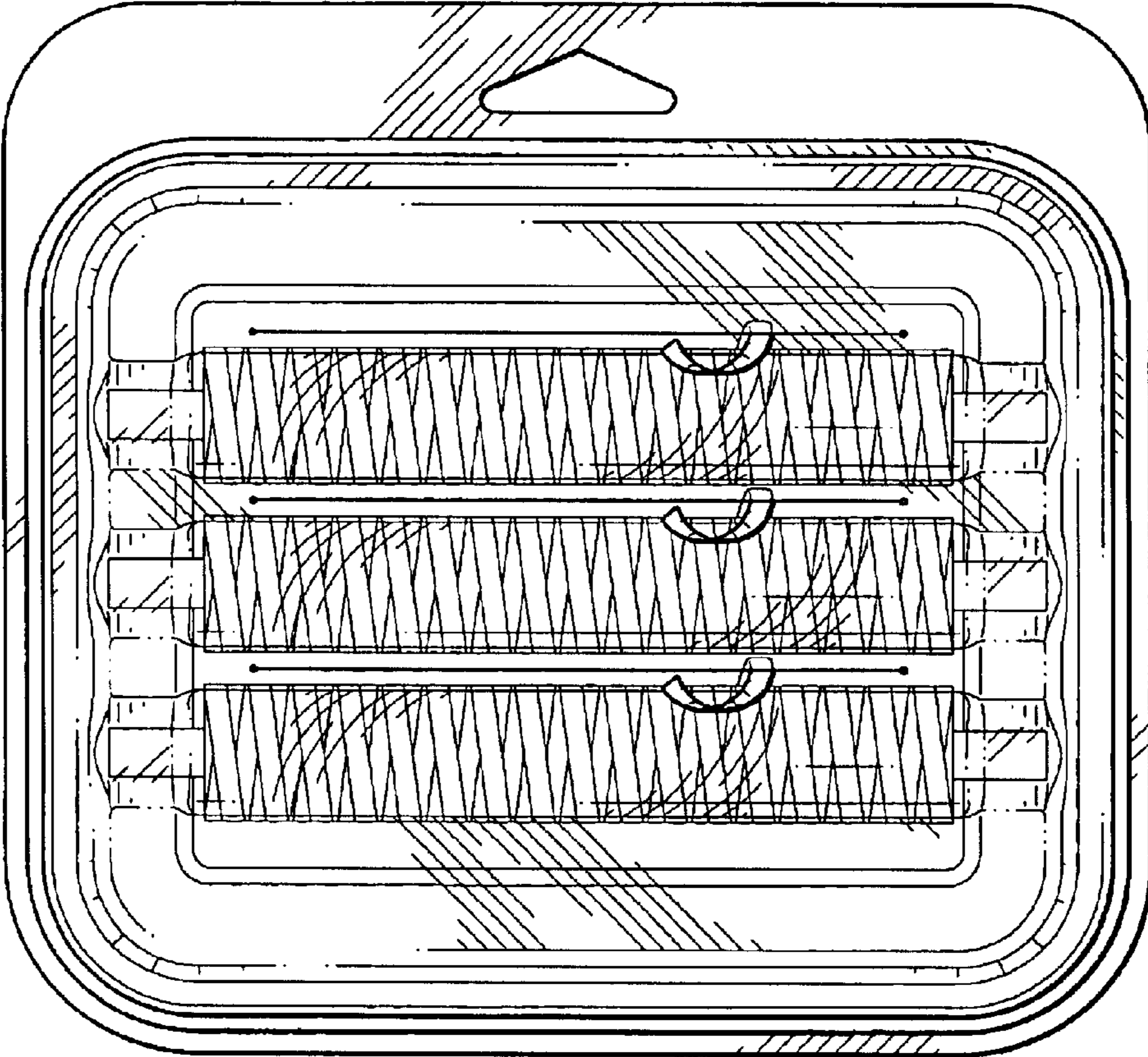

FIG. 2

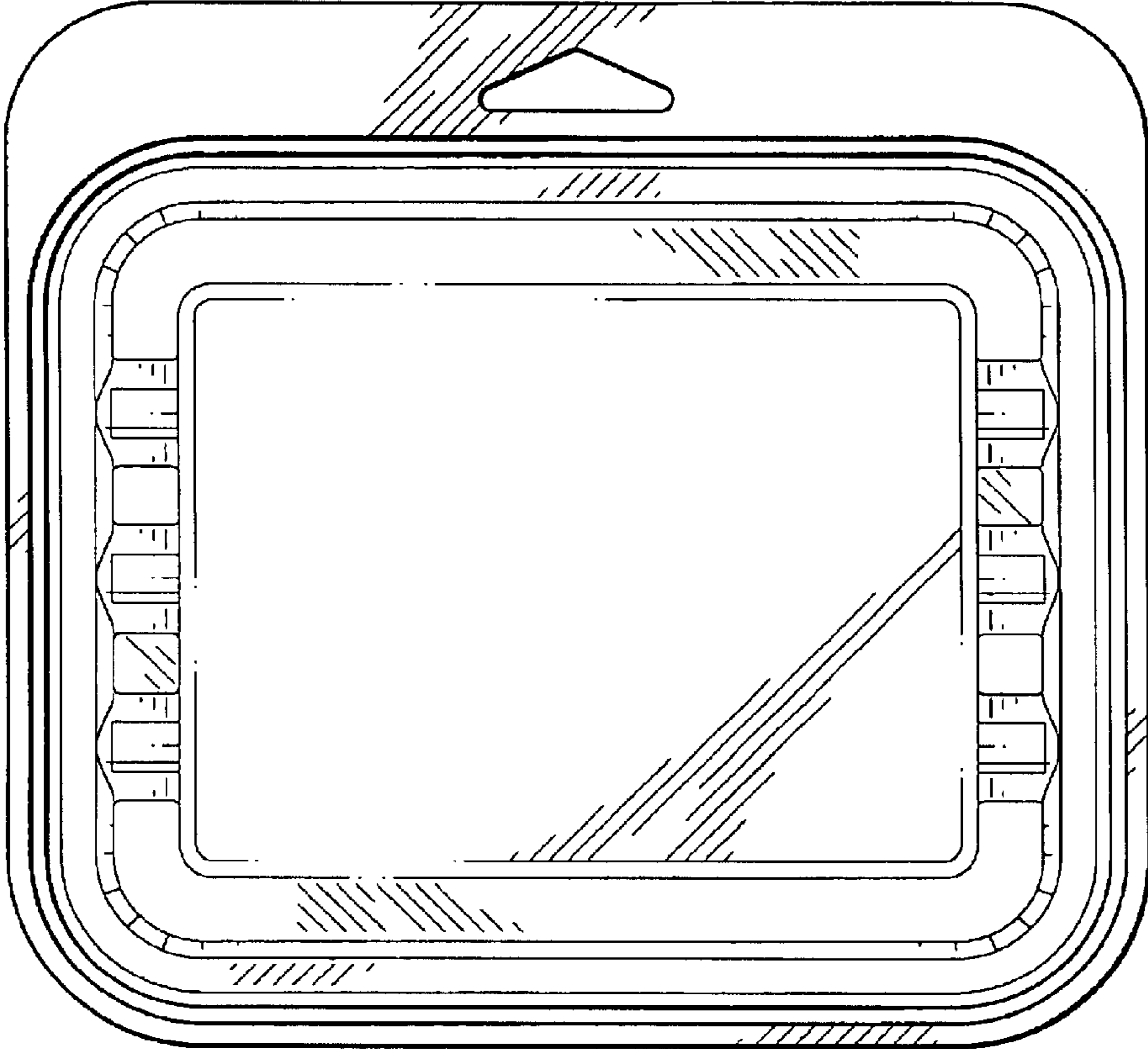

FIG. 3

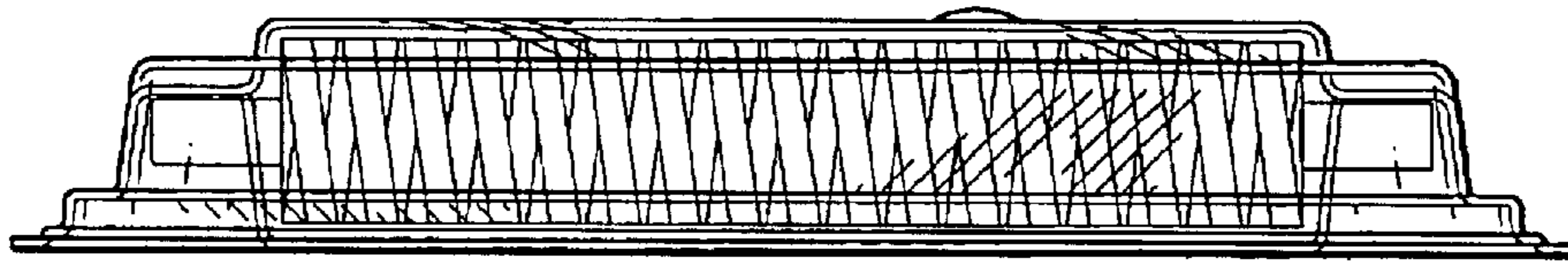

FIG. 4

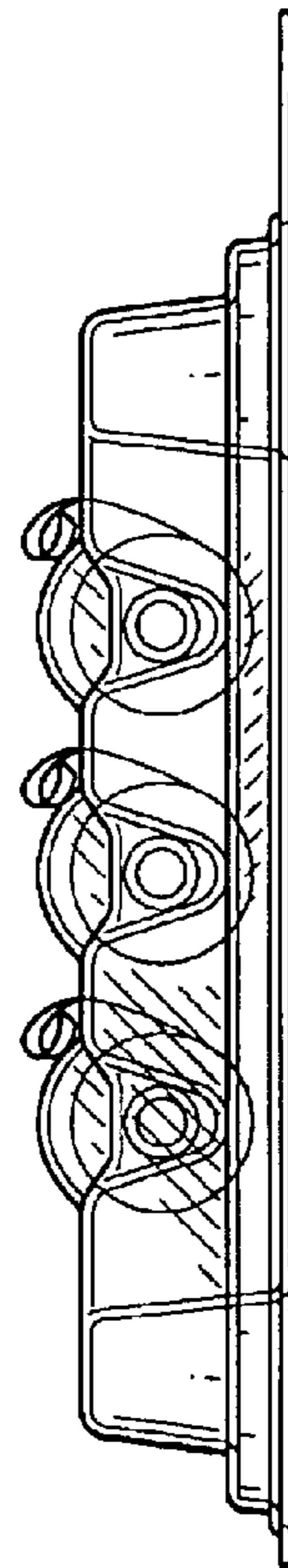

FIG. 5

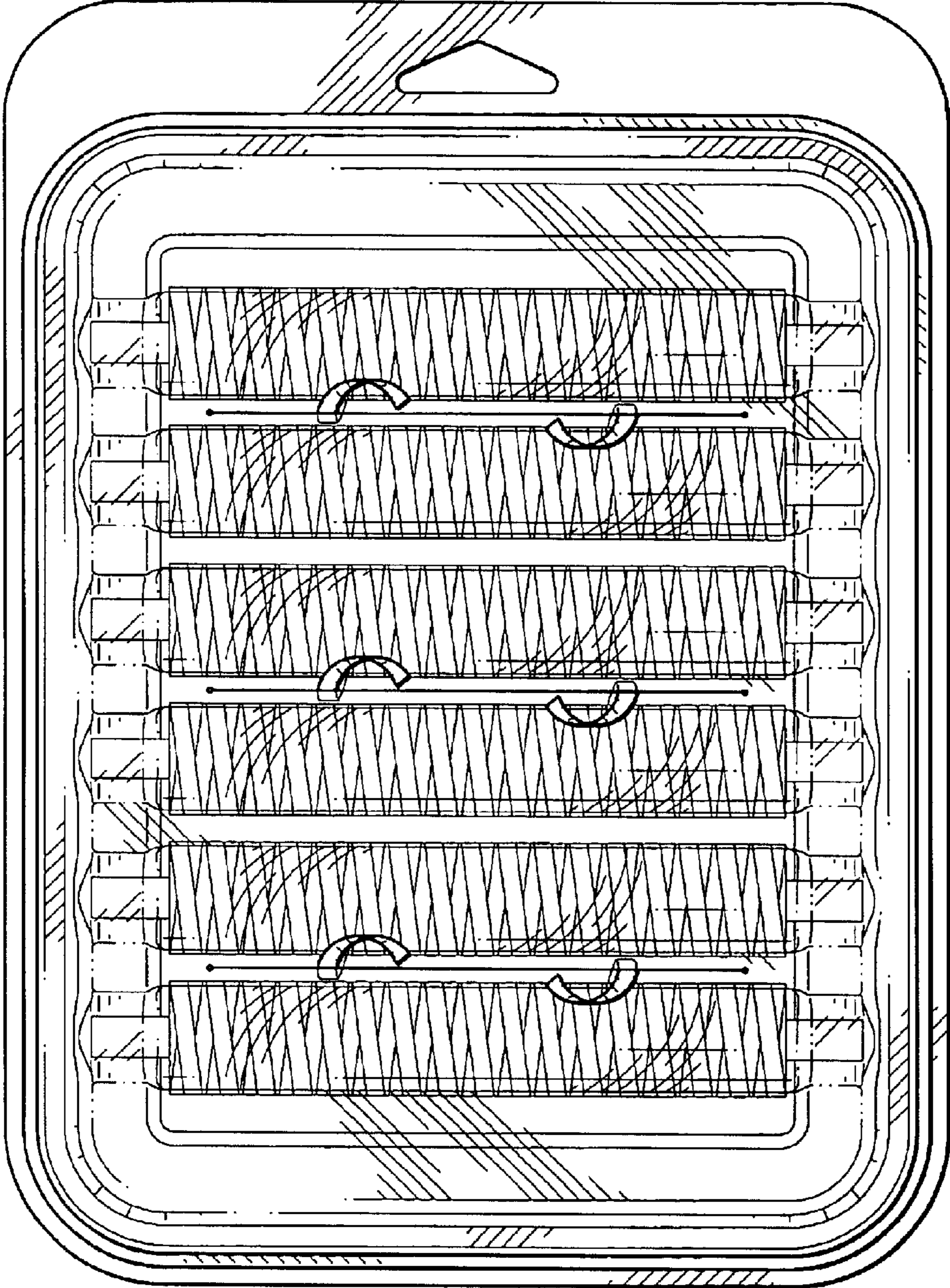

FIG. 6

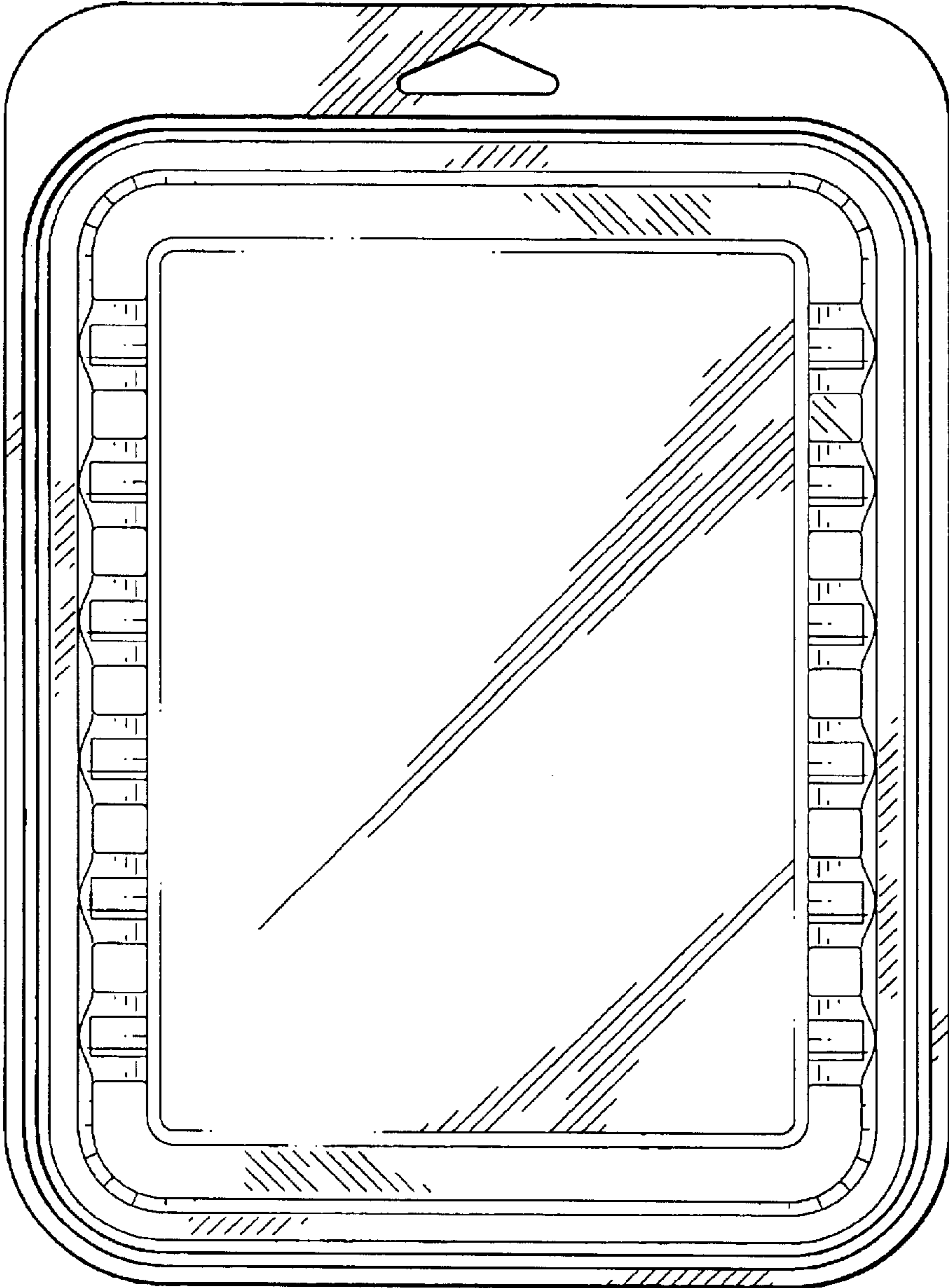

FIG. 7

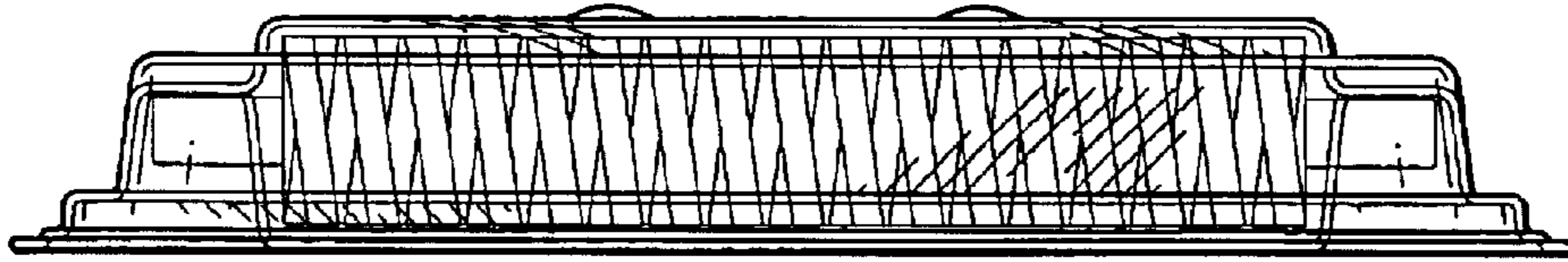

FIG. 8

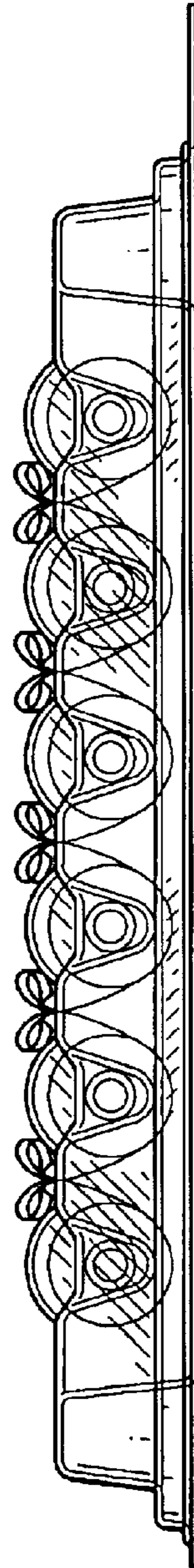

FIG. 9



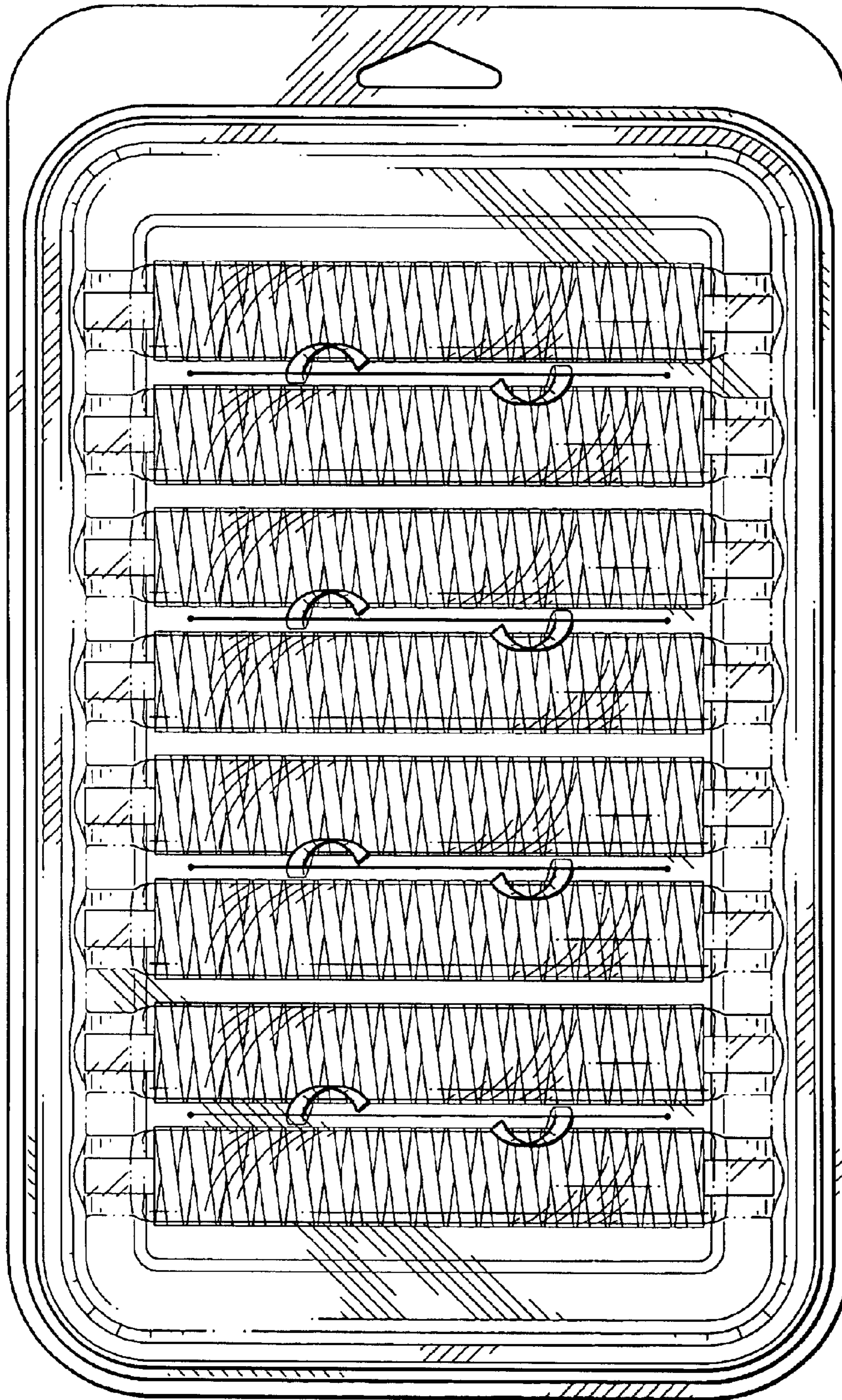

FIG. 10

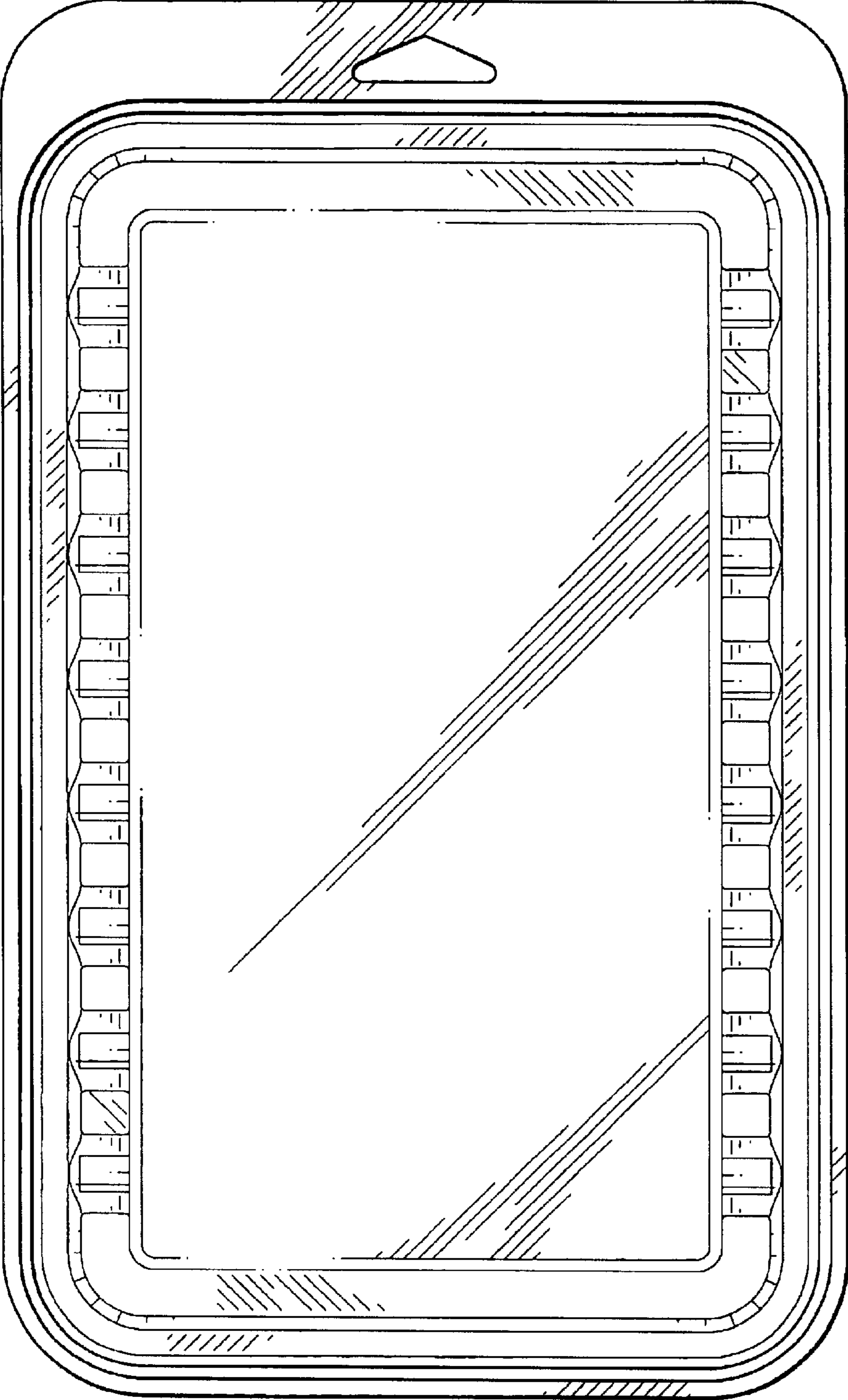

FIG. 11

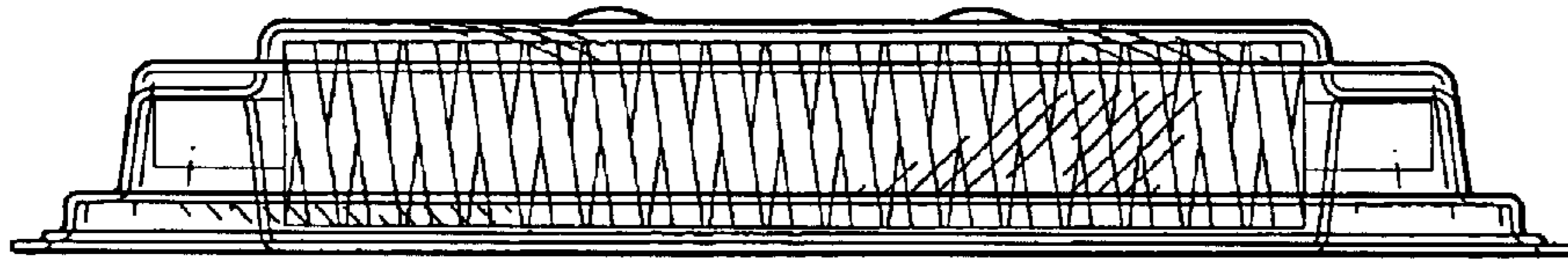

FIG. 12

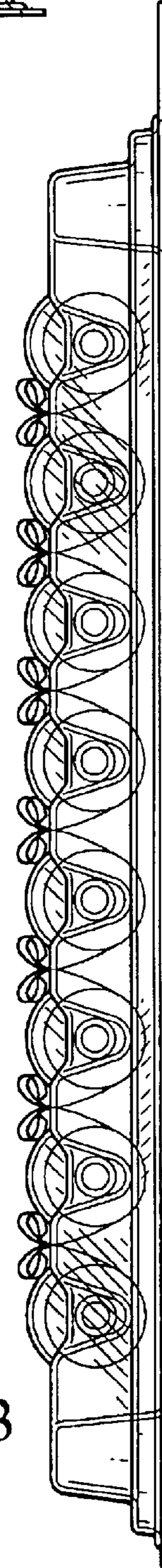

FIG. 13