

US00D498978S

(12) **United States Design Patent**
Yang

(10) **Patent No.:** **US D498,978 S**

(45) **Date of Patent:** **** Nov. 30, 2004**

(54) **UTILITY LIGHTER**

(76) **Inventor:** **John Jiin Chung Yang**, 15443 Proctor Ave., Suite B, Industry, CA (US) 91745

(**) **Term:** **14 Years**

(21) **Appl. No.:** **29/191,161**

(22) **Filed:** **Oct. 3, 2003**

(51) **LOC (7) Cl.** **07-99**

(52) **U.S. Cl.** **D7/416**

(58) **Field of Search** D7/416, 417; 126/25 B, 126/401, 229; 239/588; 431/153, 344, 91, 254; D27/130, 139-161

D462,235 S	*	9/2002	Chevalier et al.	D7/416
D462,574 S	*	9/2002	Chen	D7/416
D466,370 S	*	12/2002	Kim	D7/416
6,488,493 B2	*	12/2002	Sung	431/153
D468,586 S	*	1/2003	Saito et al.	D7/416
D472,765 S	*	4/2003	Deffner	D7/416
D473,103 S	*	4/2003	Sung	D7/416
D480,266 S	*	10/2003	Kim	D7/416
2001/0001705 A1	*	5/2001	Ferrara et al.	431/153
2003/0039934 A1	*	2/2003	Wang et al.	431/153
2004/0131985 A1	*	7/2004	Salto	431/153

* cited by examiner

Primary Examiner—M. N. Pandozzi

(74) *Attorney, Agent, or Firm*—Raymond Y. Chan; David and Raymond Patent Group

(56) **References Cited**

U.S. PATENT DOCUMENTS

D383,357 S	*	9/1997	Ferrara, Jr.	D7/416
D390,749 S	*	2/1998	Ferrara, Jr.	D7/416
D390,750 S	*	2/1998	Sung	D7/416
D392,154 S	*	3/1998	Ferrara, Jr.	D7/416
6,010,328 A	*	1/2000	Sung	431/153
6,022,212 A	*	2/2000	Saito et al.	431/153
D424,373 S	*	5/2000	Aronson, II	D7/416
D429,445 S	*	8/2000	Sung	D7/416
D440,821 S	*	4/2001	Yu	D7/416
6,217,313 B1	*	4/2001	Luo	431/153
D458,805 S	*	6/2002	Christen	D7/416

(57) **CLAIM**

The ornamental design for a utility lighter, as shown.

DESCRIPTION

FIG. 1 is a perspective view showing my new design.
FIG. 2 is a front view thereof.
FIG. 3 is a rear view thereof.
FIG. 4 is a left end view thereof.
FIG. 5 is a right end view thereof.
FIG. 6 is a top view thereof; and,
FIG. 7 is a bottom view thereof.

1 Claim, 7 Drawing Sheets

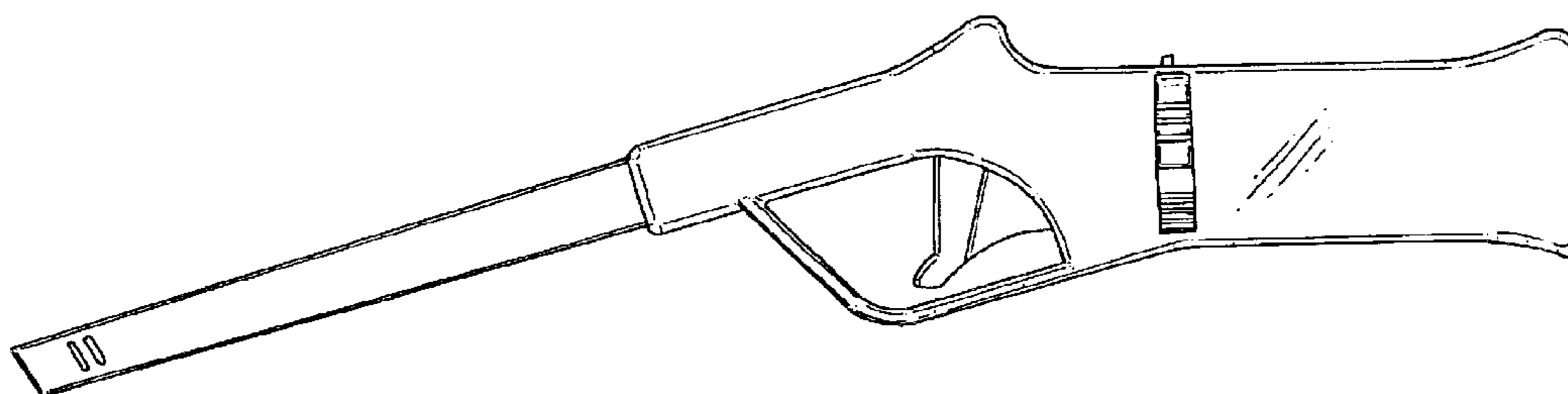
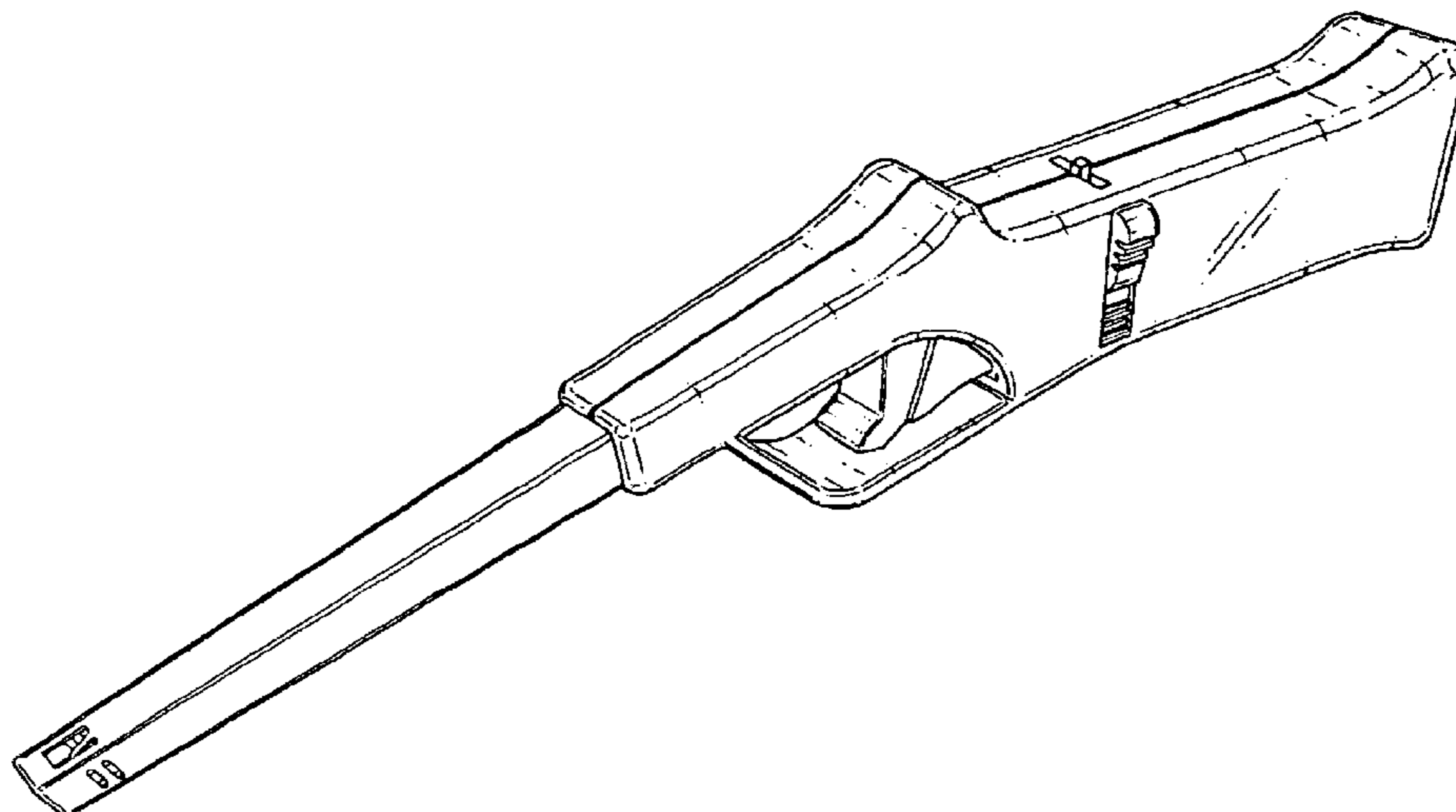

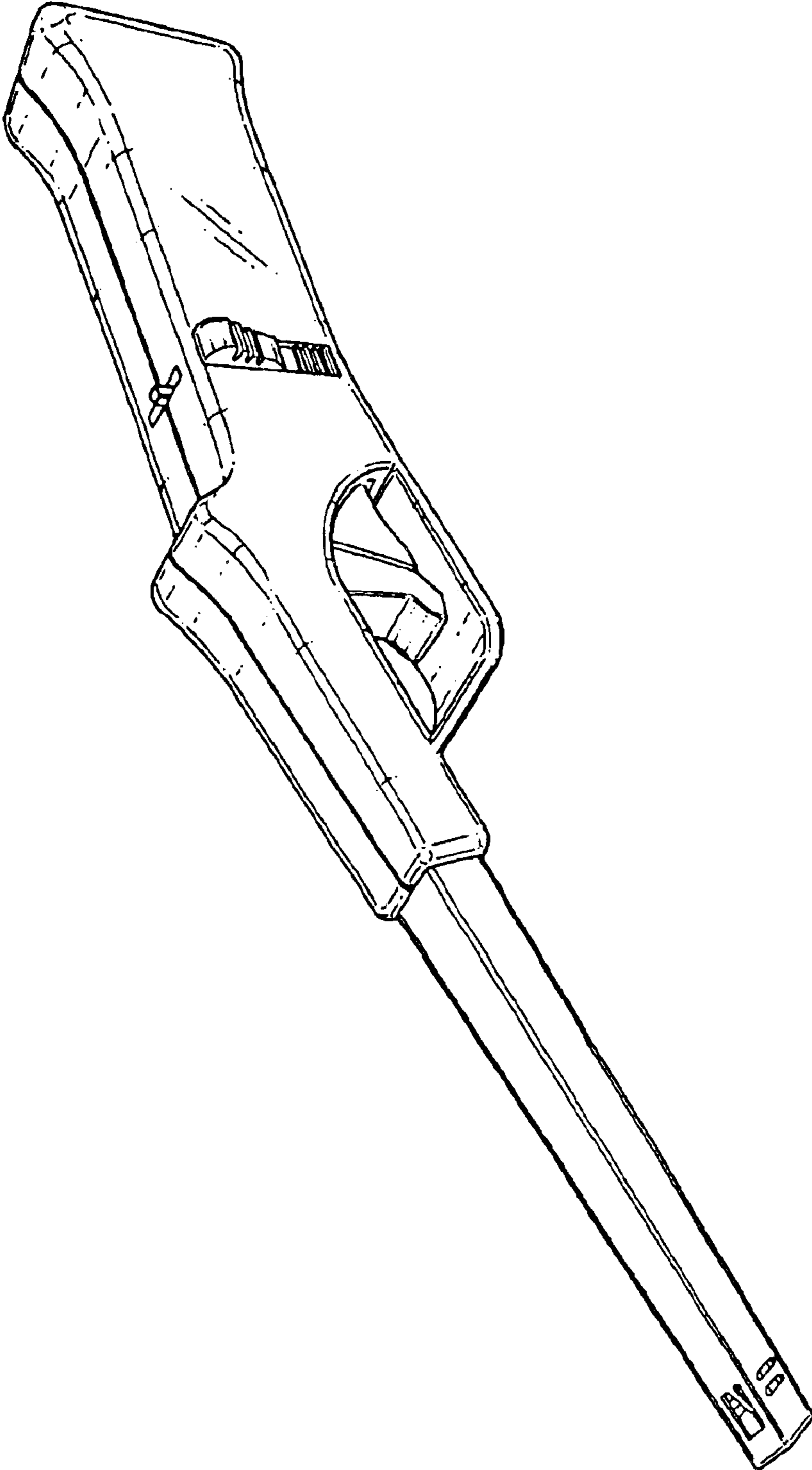

FIG. 1

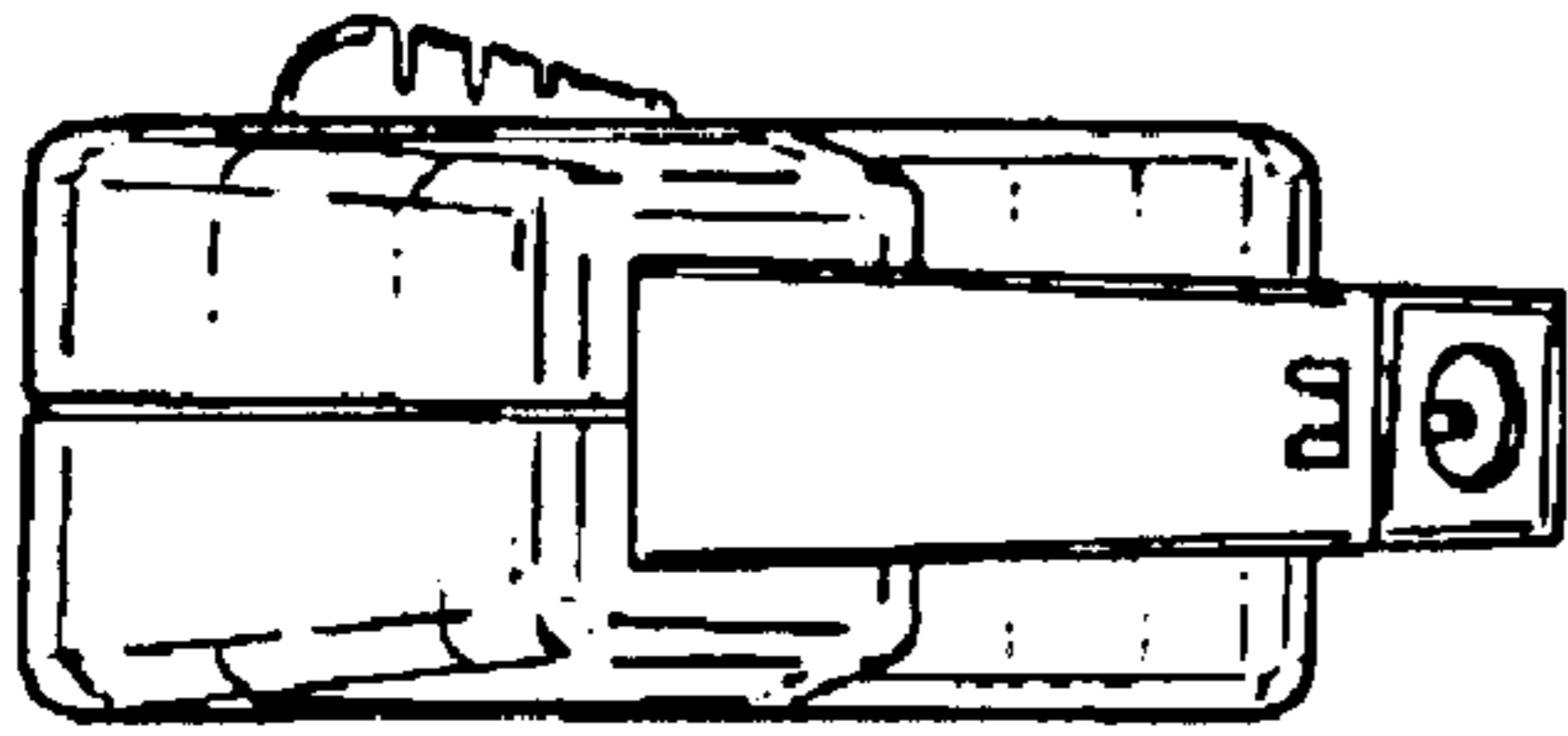

FIG. 2

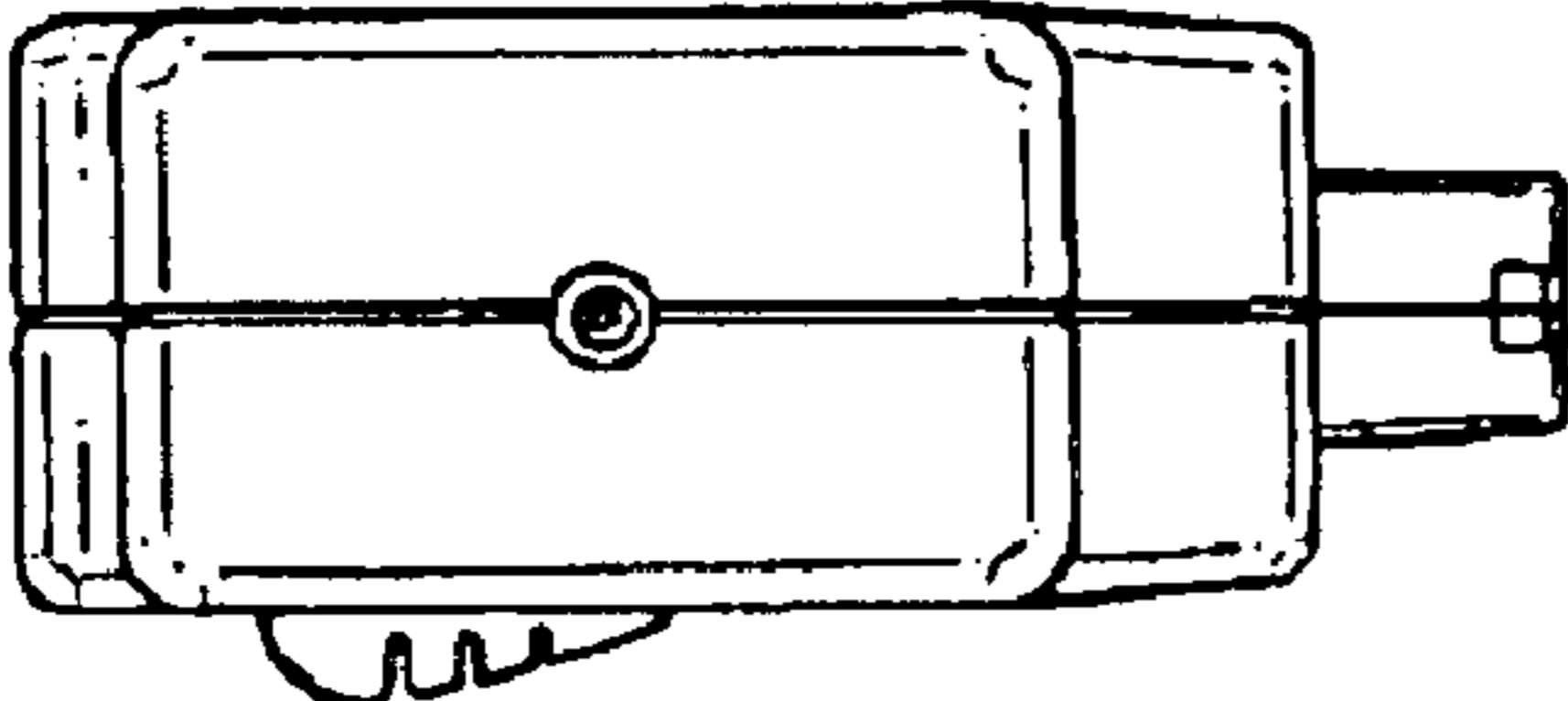

FIG. 3

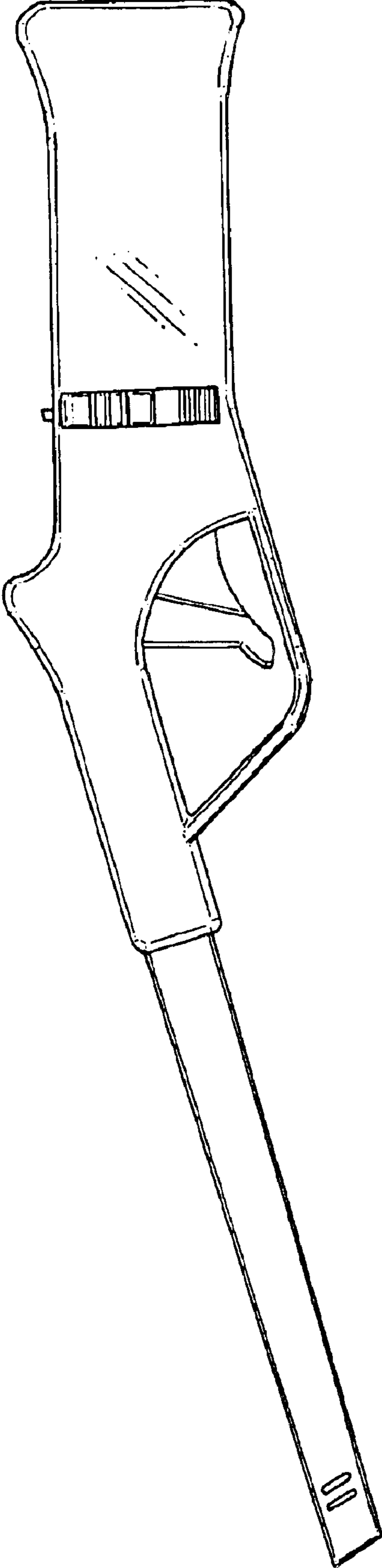

FIG. 4

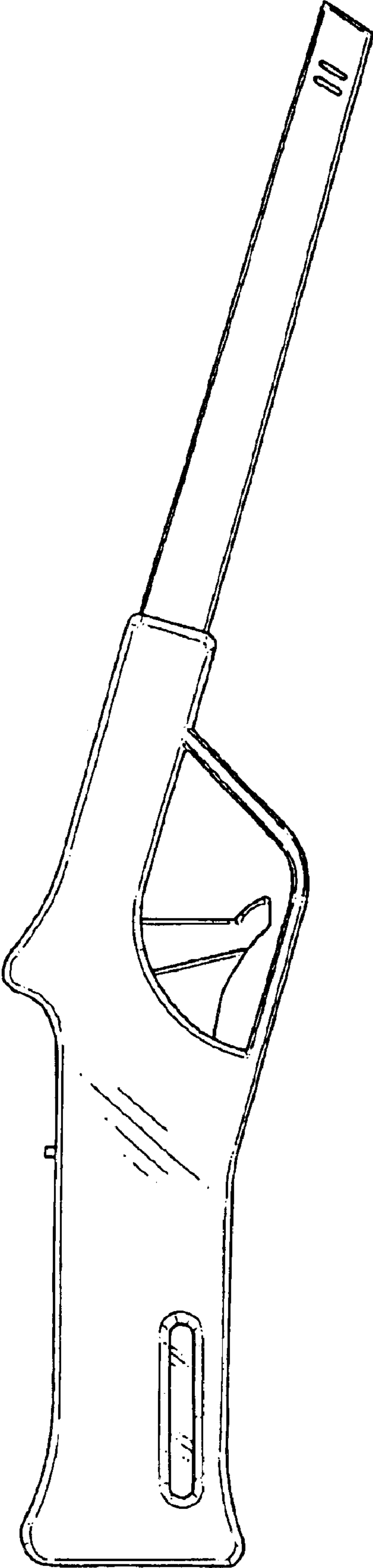

FIG. 5

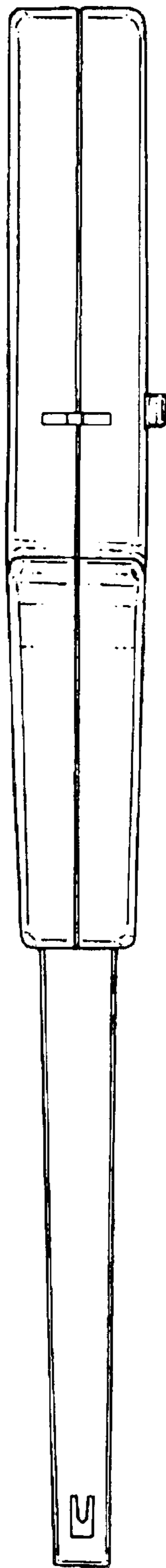

FIG. 6

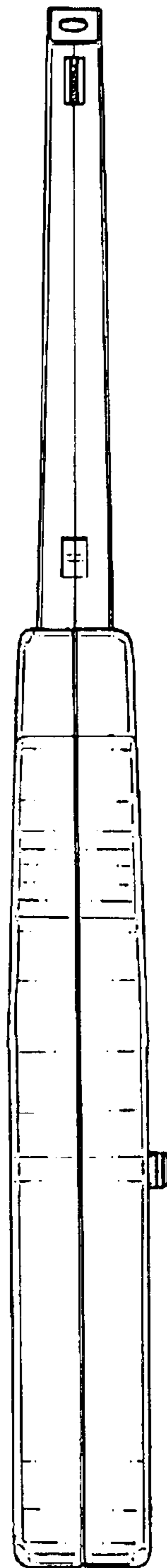

FIG. 7