



US00D498957S

(12) **United States Design Patent**  
**Benson**

(10) **Patent No.:** **US D498,957 S**

(45) **Date of Patent:** **\*\* Nov. 30, 2004**

(54) **BATH ACCESSORY POST**

(75) **Inventor:** **Kenneth Roger Benson**, Southbury, CT  
(US)

(73) **Assignee:** **Bath Unlimited, Inc.**, Randolph, NJ  
(US)

(\*\*) **Term:** **14 Years**

(21) **Appl. No.:** **29/202,551**

(22) **Filed:** **Apr. 1, 2004**

(51) **LOC (7) Cl.** ..... **23-02**

(52) **U.S. Cl.** ..... **D6/524**

(58) **Field of Search** ..... D6/546-550, 518-519,  
D6/522-524; D8/300, 303, 315-321, 354,  
363, 373, 380; 108/28-29; 211/13.1, 16,  
60.1, 86.01, 87.01, 88.01, 88.04, 100, 105.1-105.2,  
123, 126.1, 133.6, 134, 181.1, 182; 248/175,  
176.1, 200, 251, 302, 309.1; 16/110.1,  
412, 415; 242/570, 590, 595-598; 206/389,  
557

(56) **References Cited**

**U.S. PATENT DOCUMENTS**

D155,168 S \* 9/1949 Kiehl ..... D6/550  
D204,057 S \* 3/1966 Logan et al. .... D6/524

D375,011 S \* 10/1996 Lee ..... D6/550  
D418,345 S \* 1/2000 Chen ..... D6/550  
D432,832 S \* 10/2000 Gastelum et al. .... D6/524  
D451,738 S \* 12/2001 Yeh ..... D6/550  
D455,593 S \* 4/2002 Hoernig ..... D6/550  
D492,523 S \* 7/2004 Graves et al. .... D6/524

\* cited by examiner

*Primary Examiner*—Brian N Vinson

(74) *Attorney, Agent, or Firm*—Edgar A. Zarins; Lloyd D. Doigan

(57) **CLAIM**

The ornamental design for a bath accessory post, as shown and described.

**DESCRIPTION**

FIG. 1 is perspective view of a bath accessory post showing my new design;

FIG. 2 is a perspective view thereof, with the broken line disclosure of a portion of a towel bar being for illustrative purposes only and forming no part of the claimed design;

FIG. 3 is a front elevational view thereof;

FIG. 4 is left side view thereof;

FIG. 5 is a right side view thereof; and,

FIG. 6 is a partial cross-sectional view thereof, taken along line 6—6 of FIG. 5.

**1 Claim, 2 Drawing Sheets**

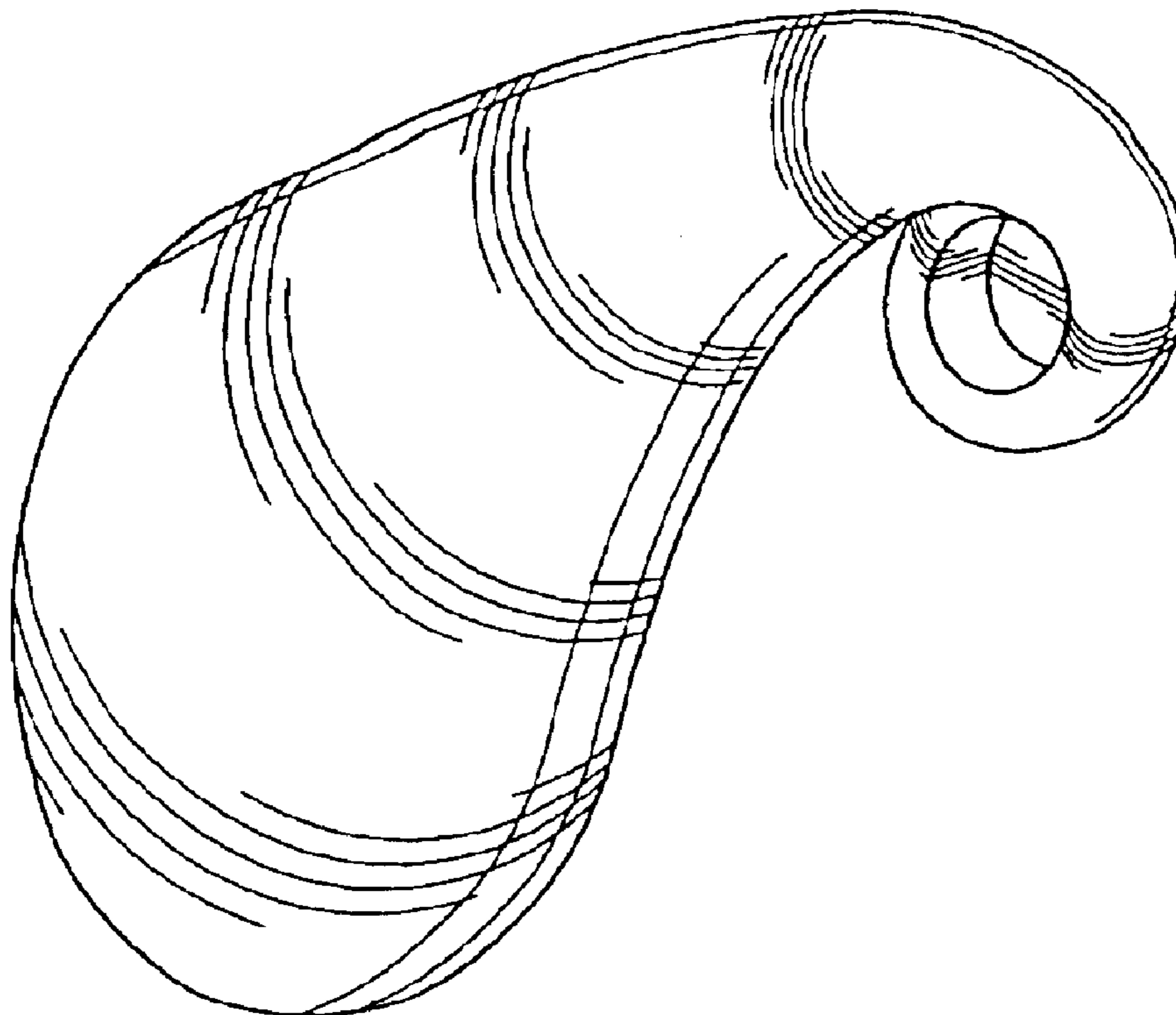

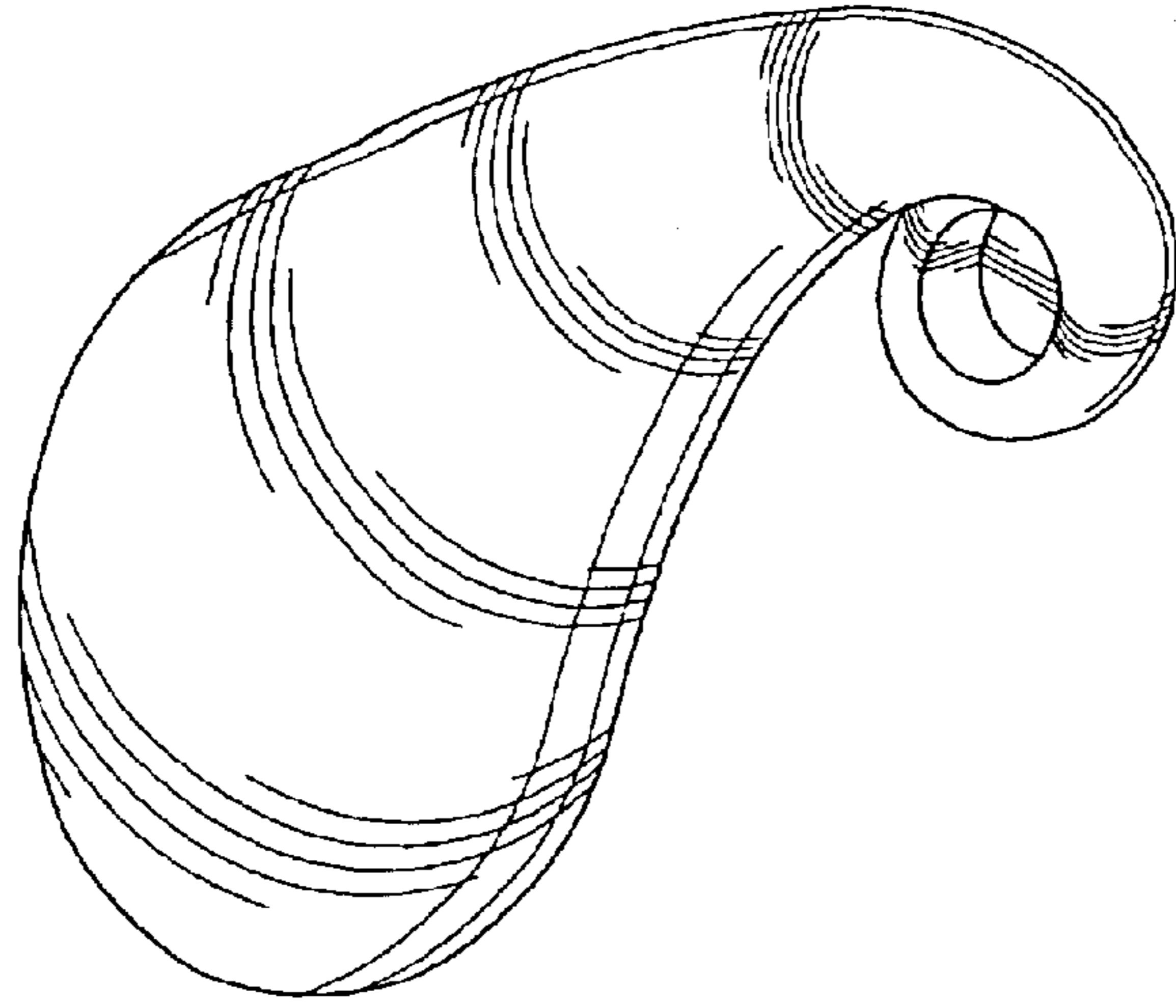

Fig-1

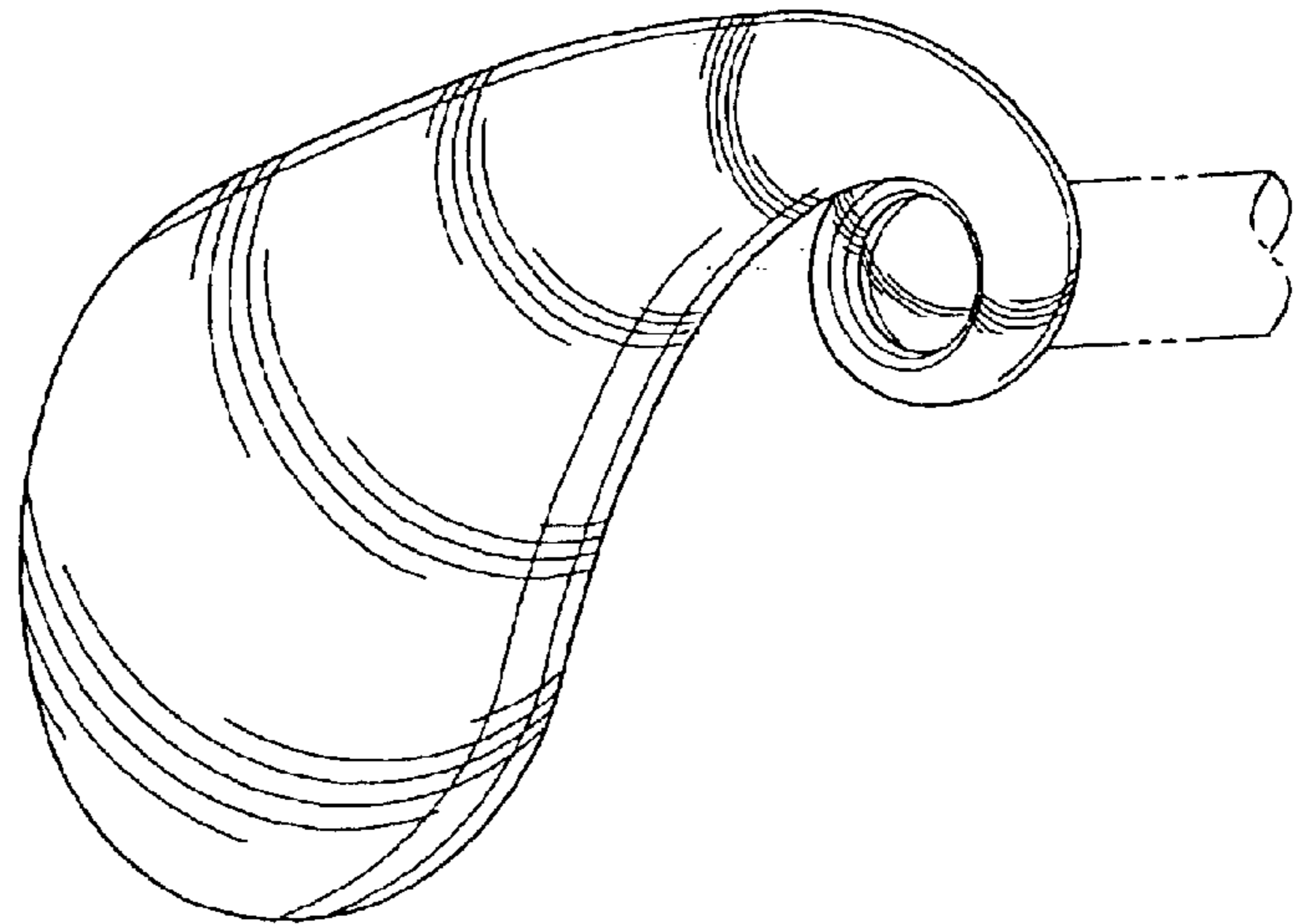

Fig-2

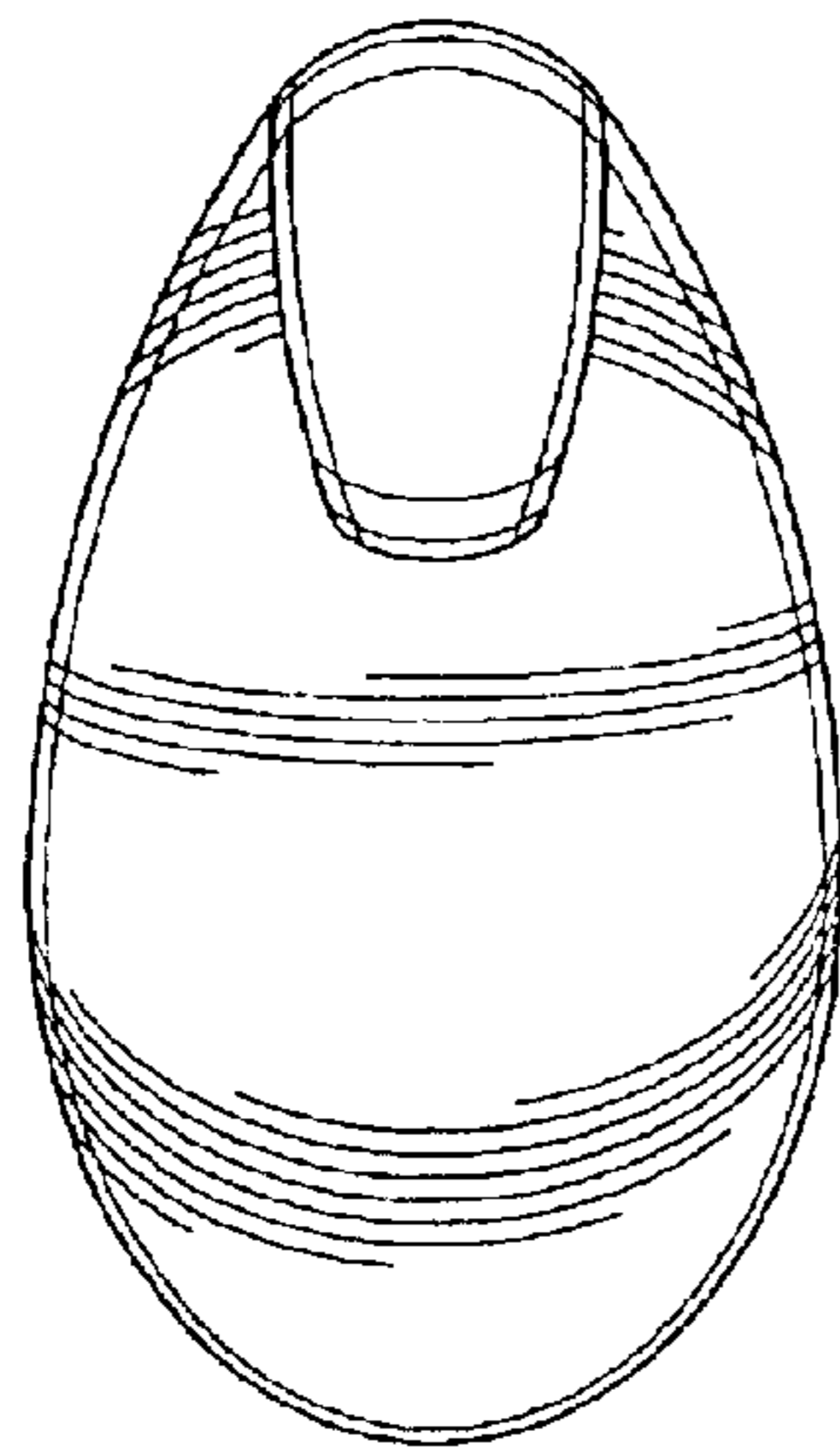

Fig-3

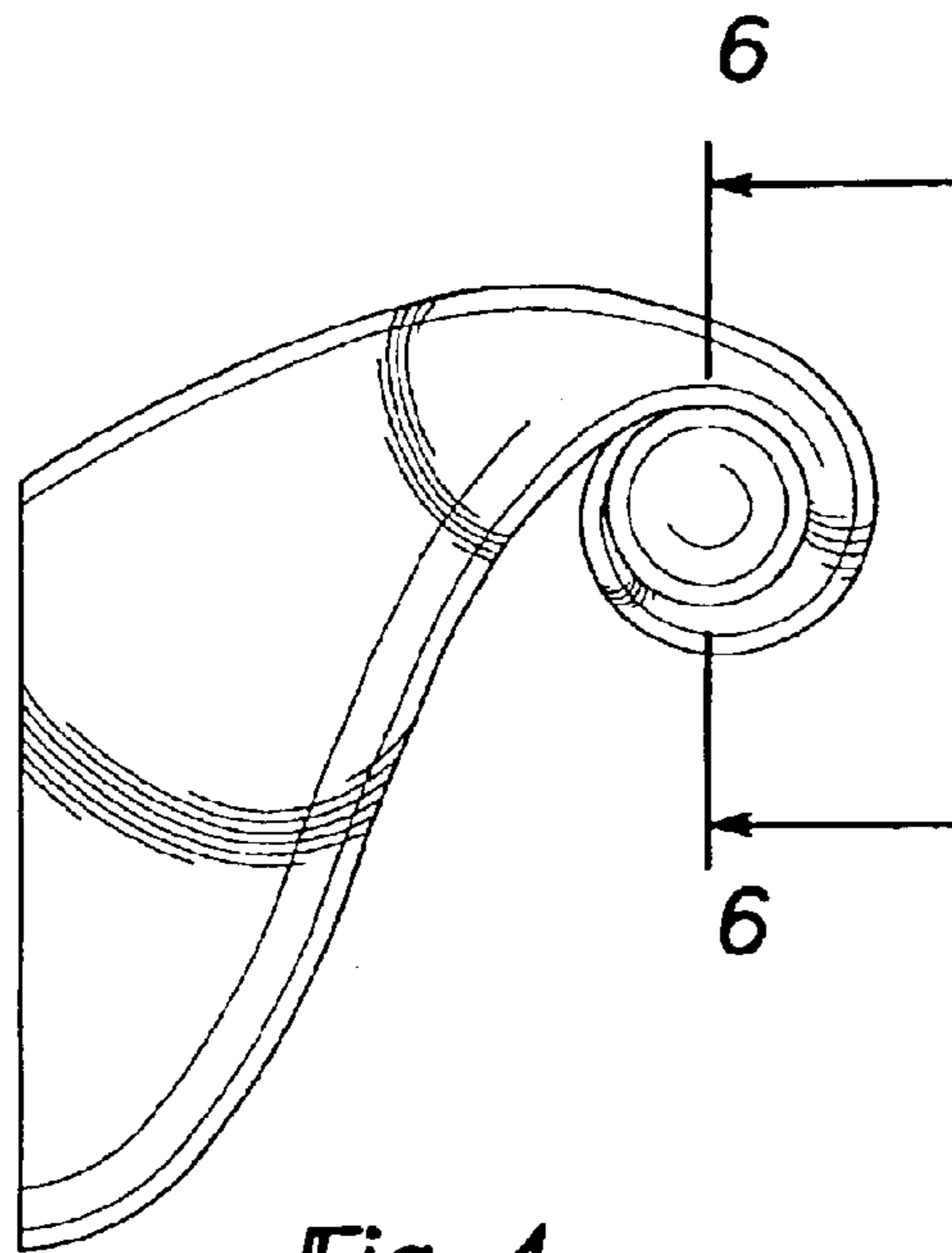

Fig-4

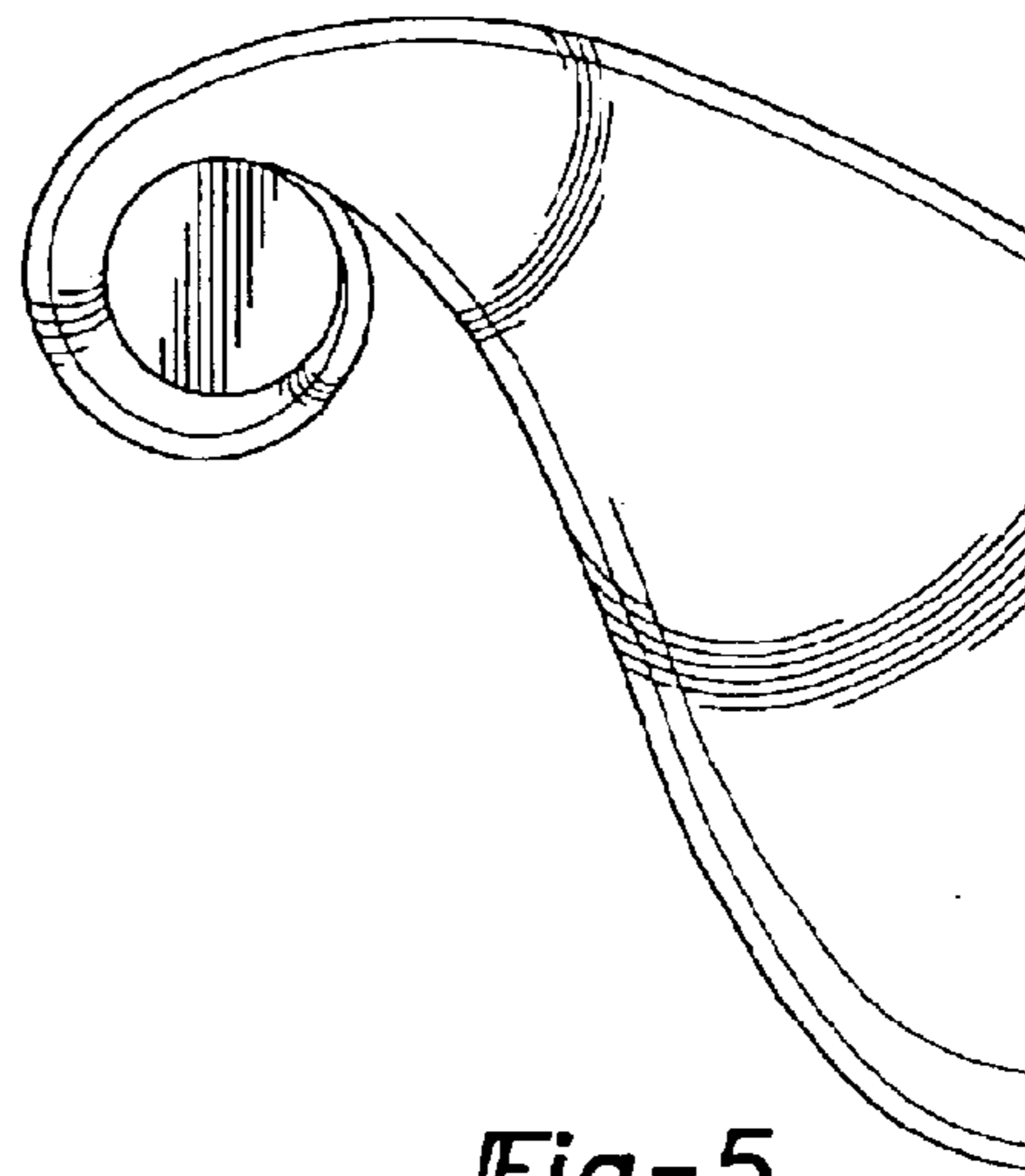

Fig-5

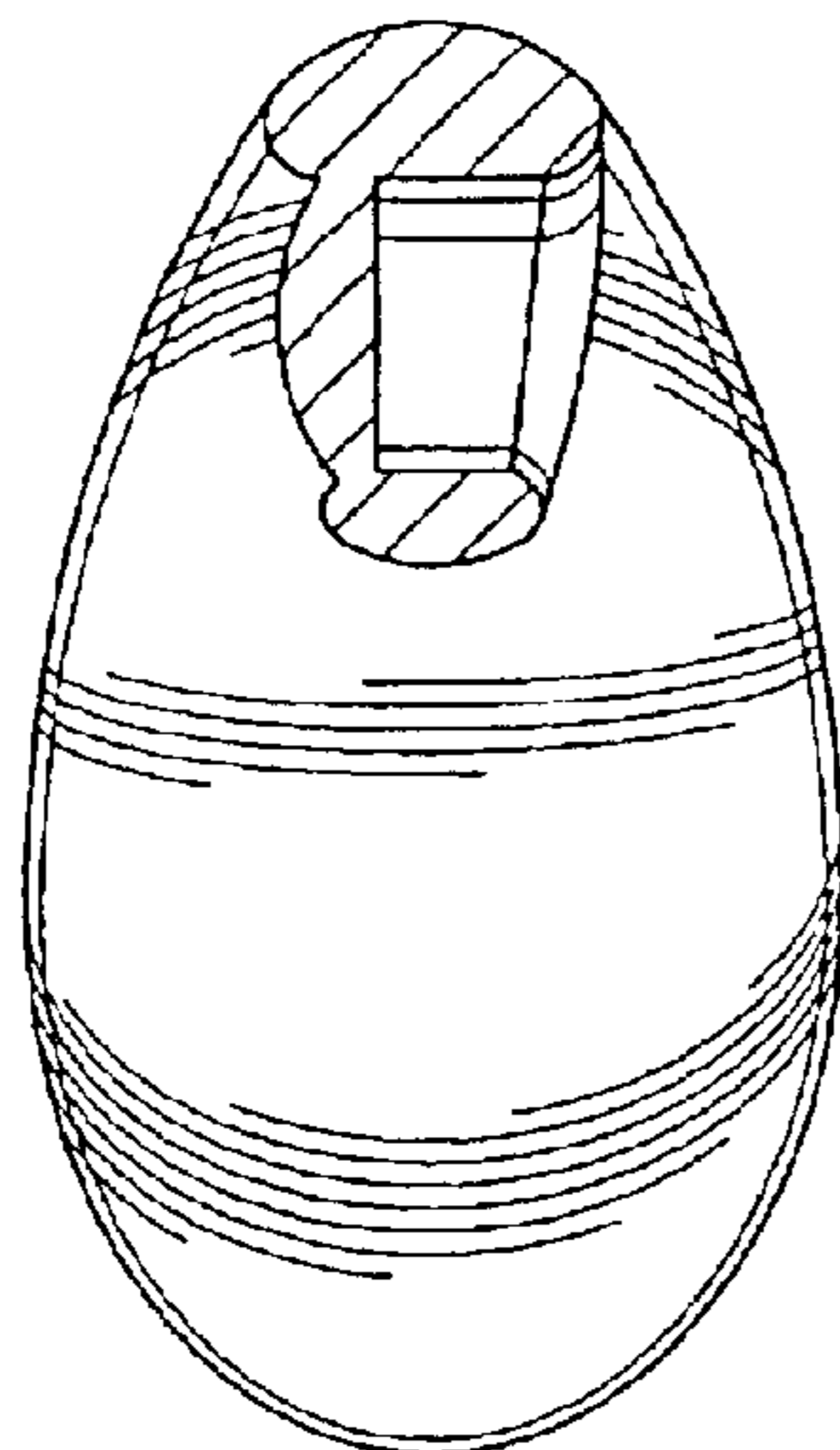

Fig-6