

US00D498632S

(12) **United States Design Patent**
Anderson et al.

(10) **Patent No.:** **US D498,632 S**

(45) **Date of Patent:** **** Nov. 23, 2004**

(54) **WIRE BASKET SHELF**

(75) Inventors: **Torrence Anderson**, Overland Park, KS
(US); **Adam Thomas**, Wheaton, IL
(US)

(73) Assignee: **Suncast Corporation**, Batavia, IL (US)

(**) Term: **14 Years**

(21) Appl. No.: **29/202,965**

(22) Filed: **Apr. 6, 2004**

(51) **LOC (7) Cl.** **06-04**

(52) **U.S. Cl.** **D6/566**

(58) **Field of Search** D6/566, 552-553,
D6/567, 572, 574, 511; D3/304, 306; 108/161;
206/557; 211/13.1, 41.3, 41.4, 86.01, 88.01,
126.1, 134, 181.1; 248/302

(56) **References Cited**

U.S. PATENT DOCUMENTS

D115,255 S * 6/1939 Taylor D6/566

D242,888 S * 1/1977 Mazie et al. D6/566
D373,039 S * 8/1996 Cohen et al. D6/566
D407,930 S * 4/1999 Camilleri et al. D6/566
D442,002 S * 5/2001 Rodack D6/566

* cited by examiner

Primary Examiner—Brian N Vinson

(74) *Attorney, Agent, or Firm*—McHale & Slavin, P.A.

(57) **CLAIM**

The ornamental design for a wire basket shelf, as shown and described.

DESCRIPTION

FIG. 1 is a perspective view of the wire basket shelf of the instant invention;
FIG. 2 is a front elevation view thereof;
FIG. 3 is a rear view thereof;
FIG. 4 is a right side view thereof;
FIG. 5 is a left side view thereof;
FIG. 6 is a top view thereof; and,
FIG. 7 is a bottom view.

1 Claim, 6 Drawing Sheets

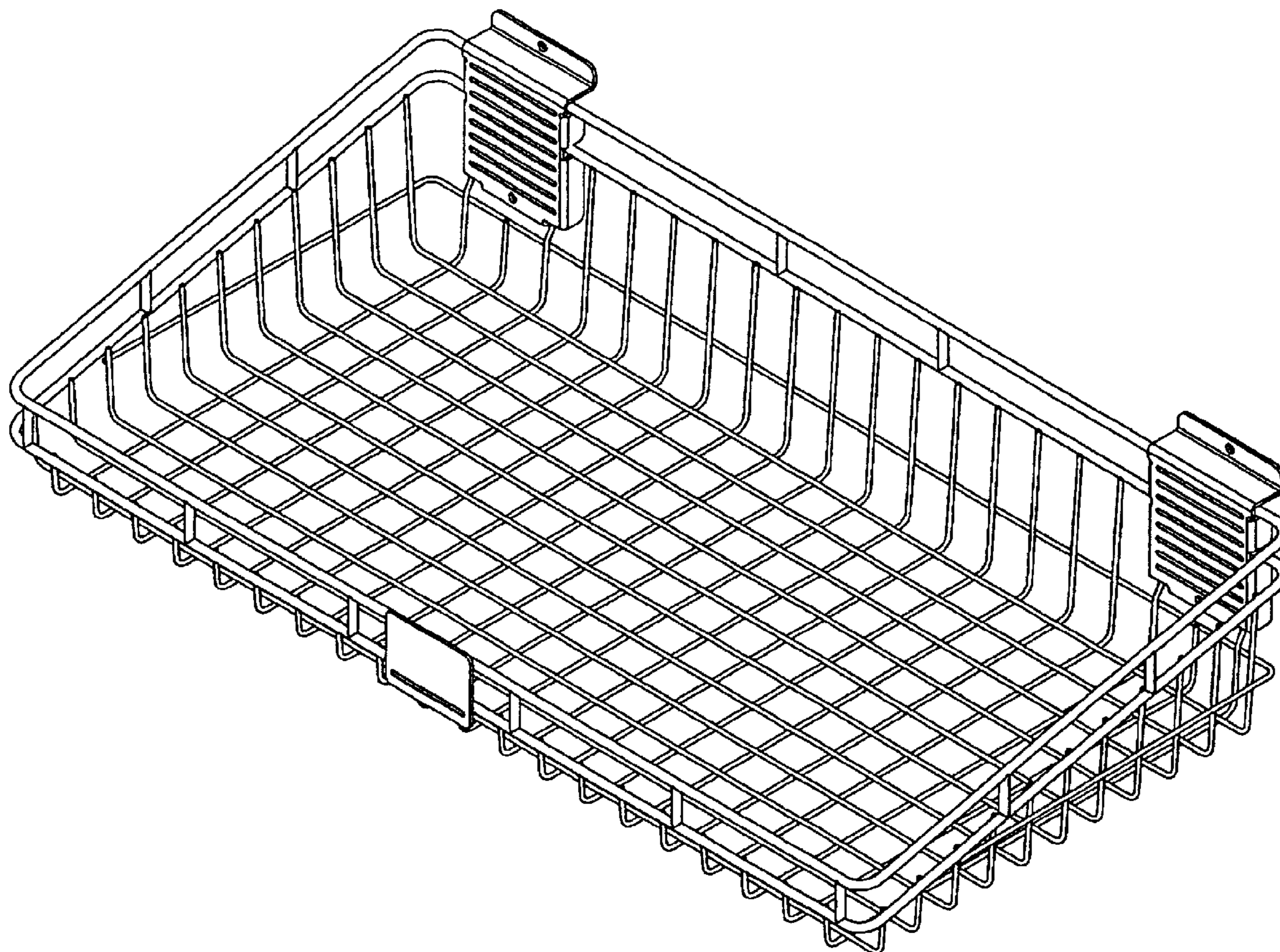

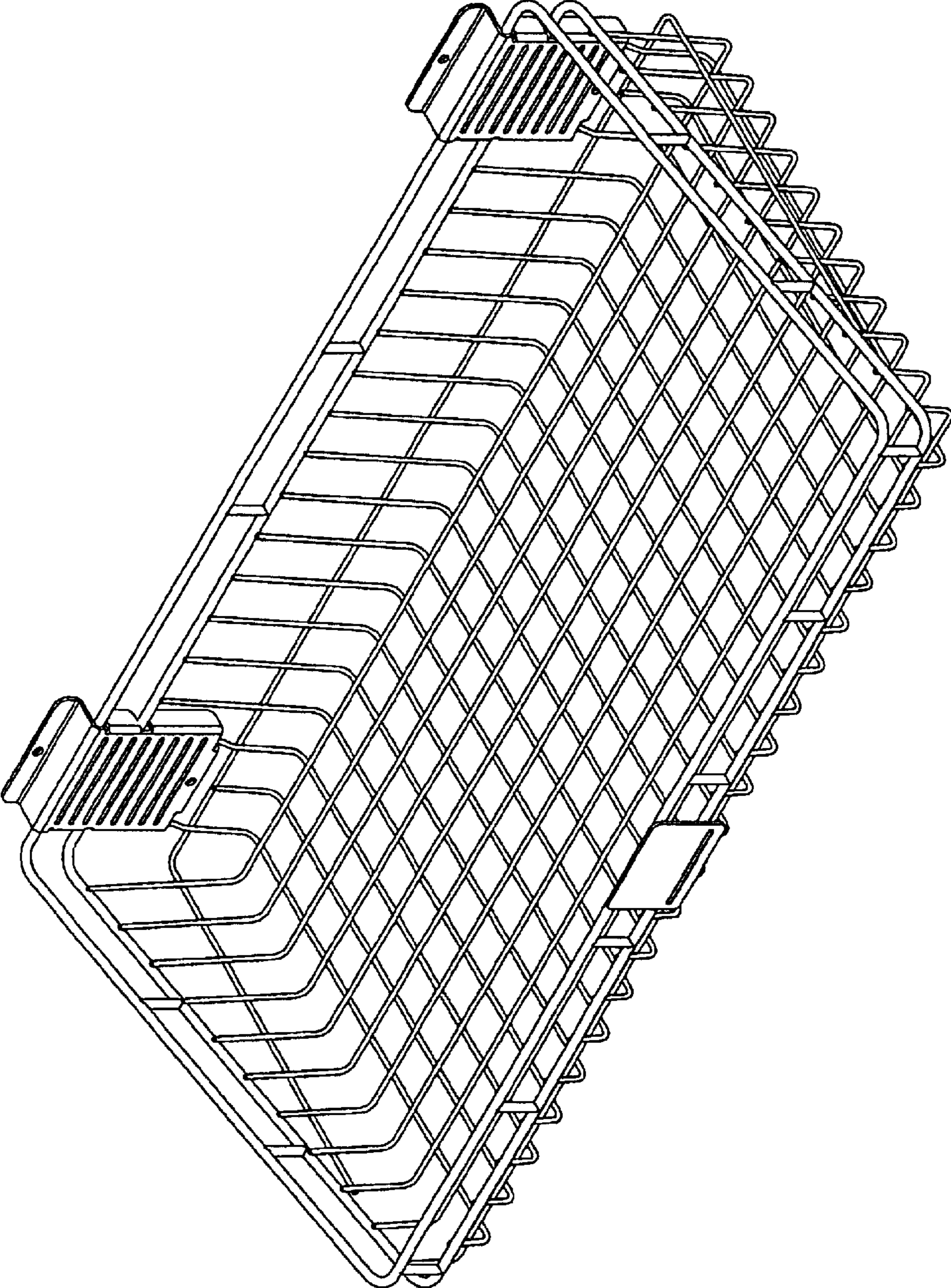

FIGURE 1

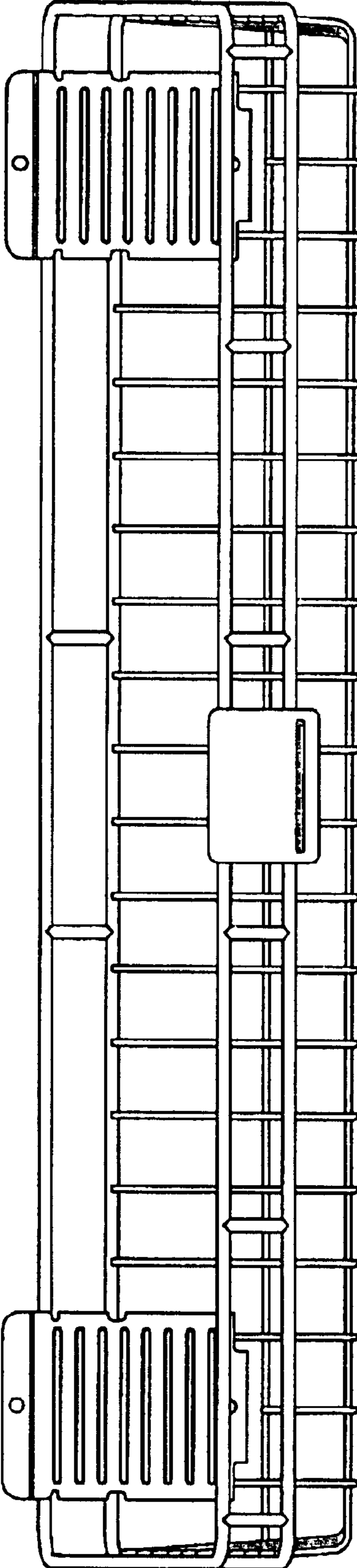

FIGURE 2

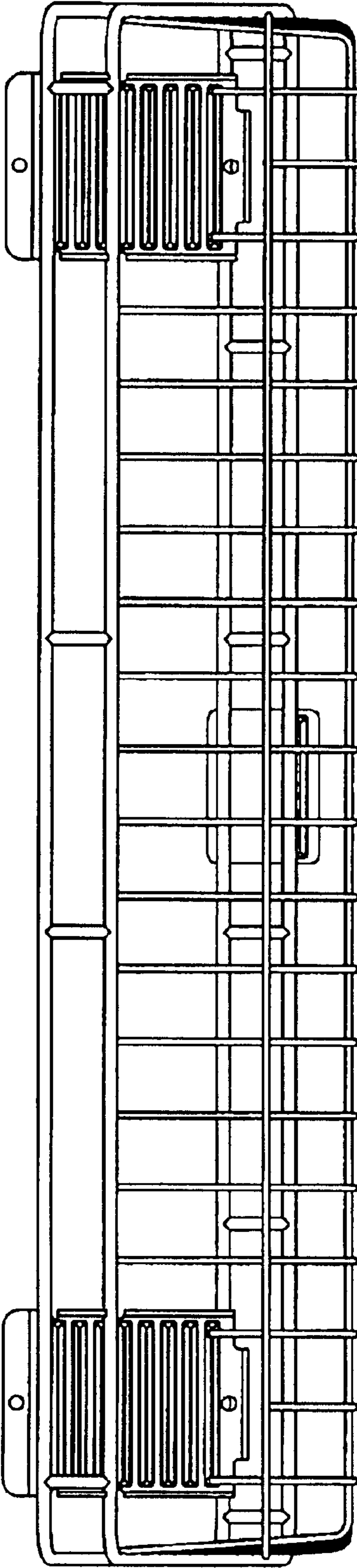

FIGURE 3

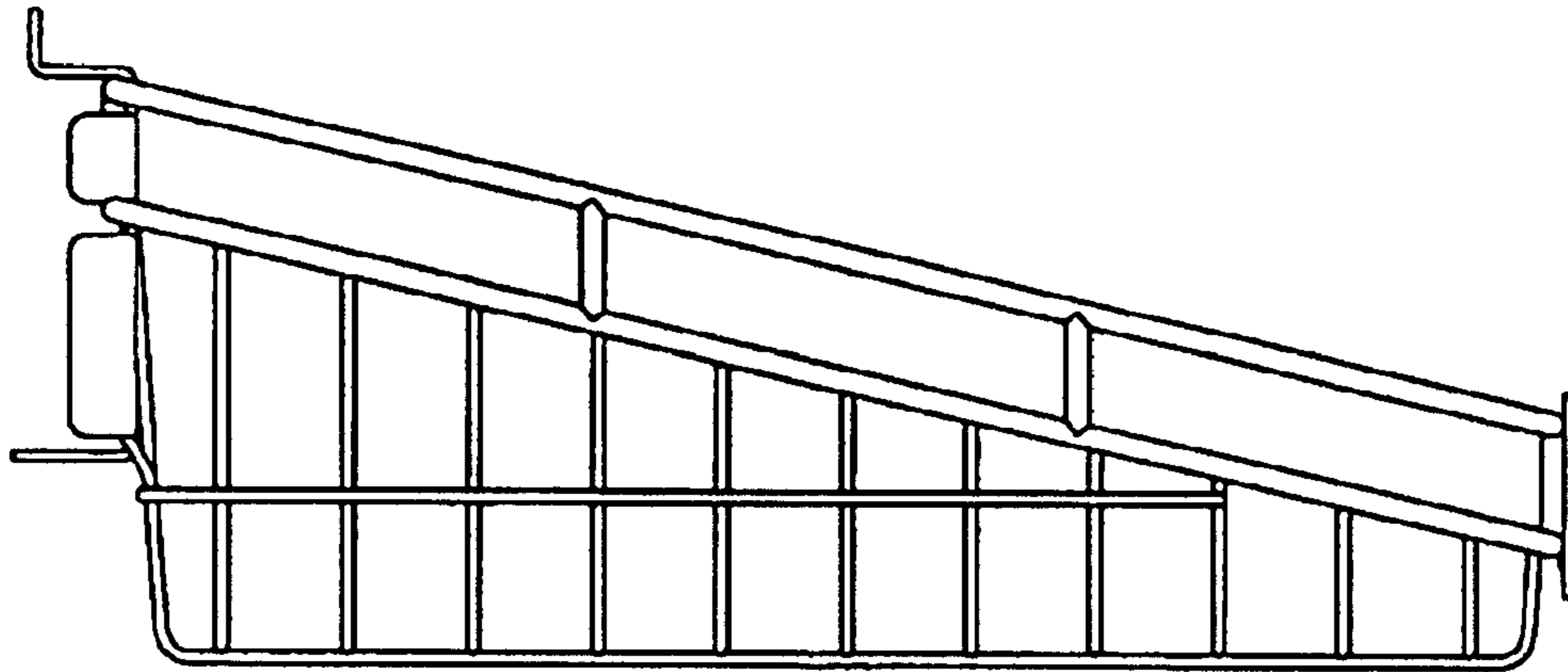

FIGURE 4

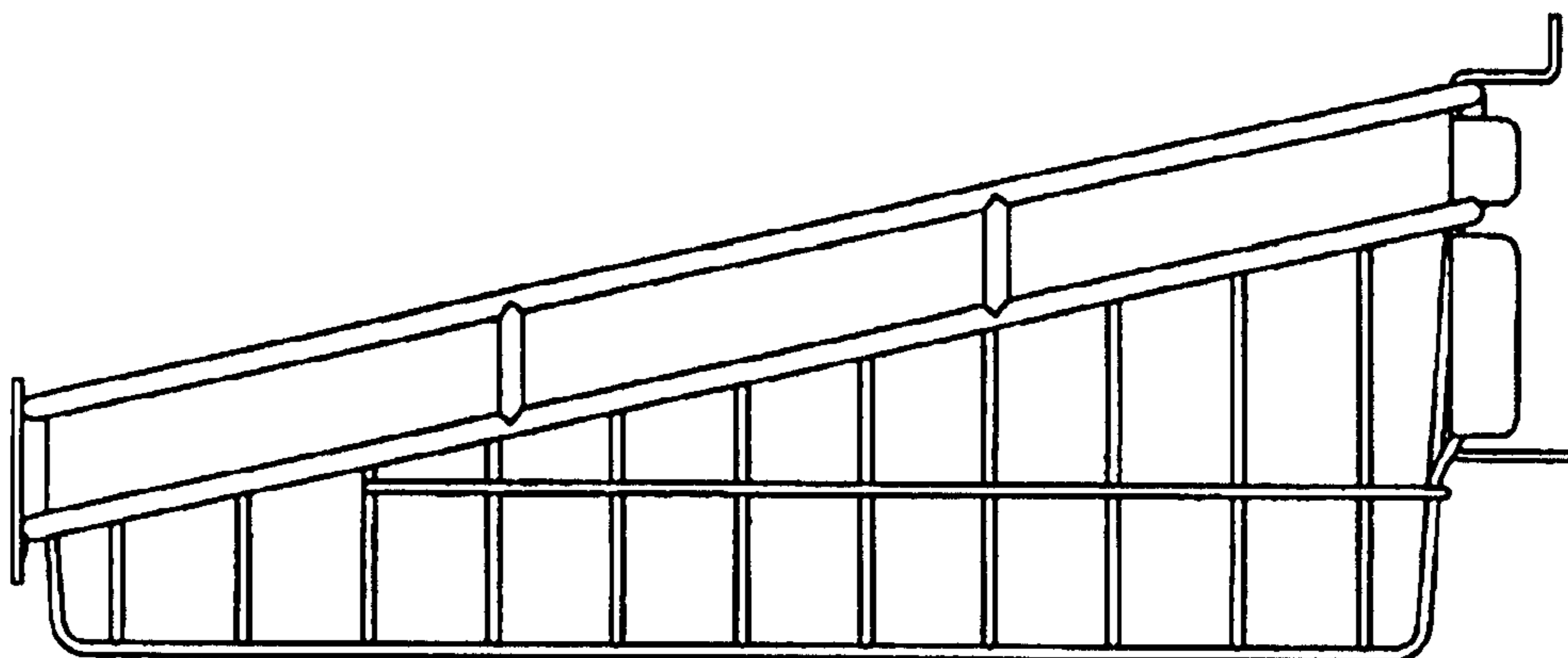

FIGURE 5

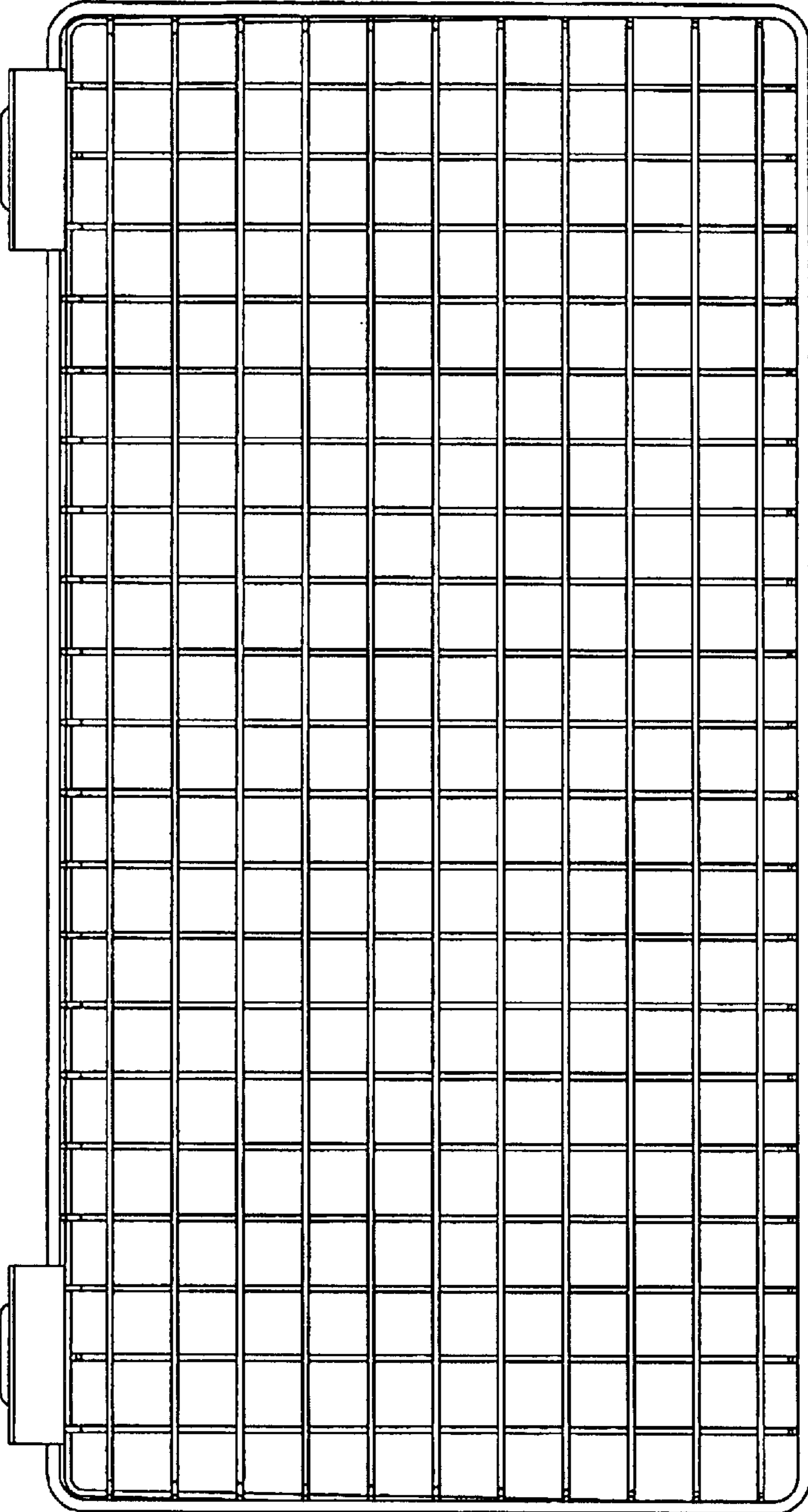

FIGURE 6

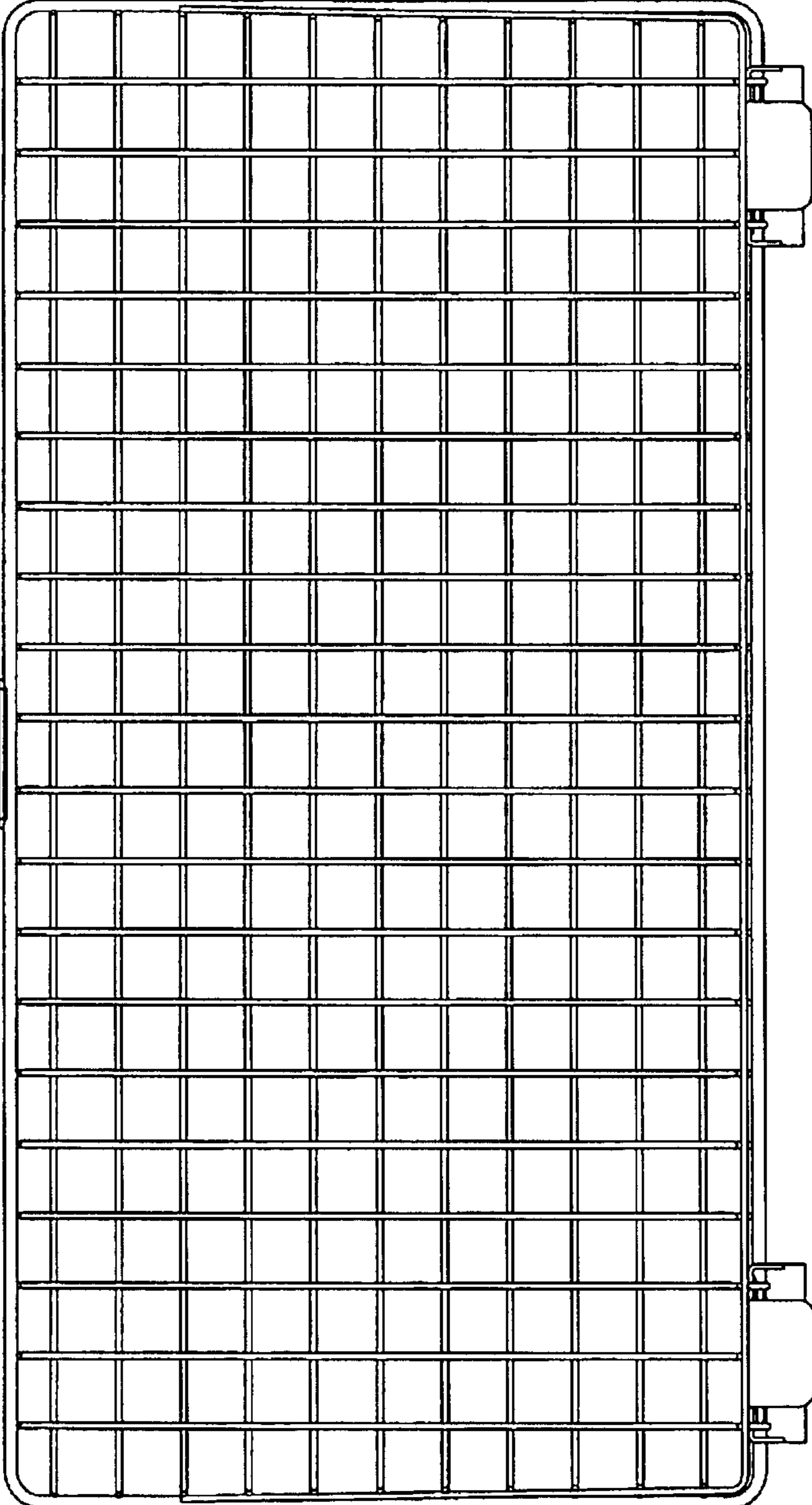

FIGURE 7