

US00D498561S

(12) **United States Design Patent** (10) **Patent No.:** **US D498,561 S**
McCambridge et al. (45) **Date of Patent:** **** Nov. 16, 2004**

(54) **HAIR STYLING IRON SUPPORT**

(74) *Attorney, Agent, or Firm*—Greer, Burns & Crain, LTD.

(75) Inventors: **James E. McCambridge**, Polo, IL (US); **Michael A. Pace**, Polo, IL (US); **Charles Choi**, Chicago, IL (US)

(57) **CLAIM**

The ornamental design for a hair styling iron support, as shown and described.

(73) Assignee: **Wahl Clipper Corporation**, Sterling, IL (US)

DESCRIPTION

(**) Term: **14 Years**

(21) Appl. No.: **29/170,627**

FIG. 1 is a top perspective view of a first embodiment of the present new design of a hair styling iron support; FIG. 2 is a top view of the support of FIG. 1; FIG. 3 is a bottom view of the support of FIG. 1; FIG. 4 is a left side view of the support of FIG. 1 with a right side view being a mirror image of this left side view; FIG. 5 is a front view of the support of FIG. 1; FIG. 6 is a rear view of the the support of FIG. 1; FIG. 7 is a top perspective view of an alternative embodiment of the present hair styling iron support; FIG. 8 is a top view of the hair styling iron support of FIG. 7; FIG. 9 is a bottom view of the support of FIG. 7; FIG. 10 is a left side view of the support of FIG. 7 with a right side view being a mirror image of this left side view; FIG. 11 is a front view of the support of FIG. 7; and, FIG. 12 is a rear view of the support of FIG. 7. The broken lines, immediately adjacent the solid line disclosure, represent the bounds of the claim and all other broken lines are for illustrative purposes only. None of the broken lines form a part of the claimed design.

(22) Filed: **Nov. 7, 2002**

(51) **LOC (7) Cl.** **28-03**

(52) **U.S. Cl.** **D28/38**

(58) **Field of Search** D28/38, 73; 211/70.6, 211/103; 248/117.1-117; 206/373

(56) **References Cited**

U.S. PATENT DOCUMENTS

D305,944 S	*	2/1990	Mellott	D28/38
5,090,649 A	*	2/1992	Tipp	248/176.2
D329,304 S	*	9/1992	Tipp	D28/38
D423,717 S	*	4/2000	Taylor	D28/38
D425,254 S	*	5/2000	Guidera	D28/73

* cited by examiner

Primary Examiner—Jennifer Rivard

1 Claim, 8 Drawing Sheets

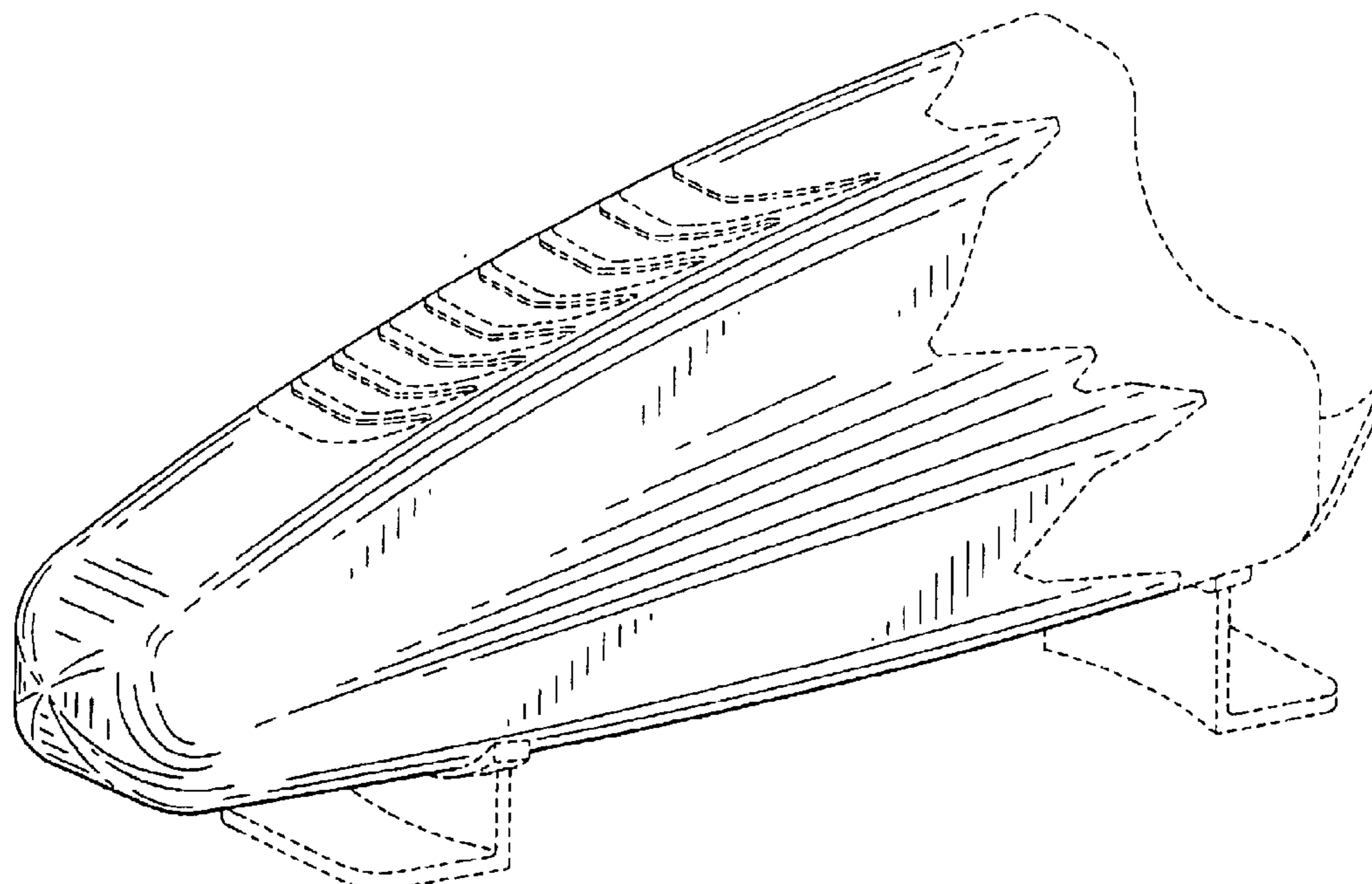

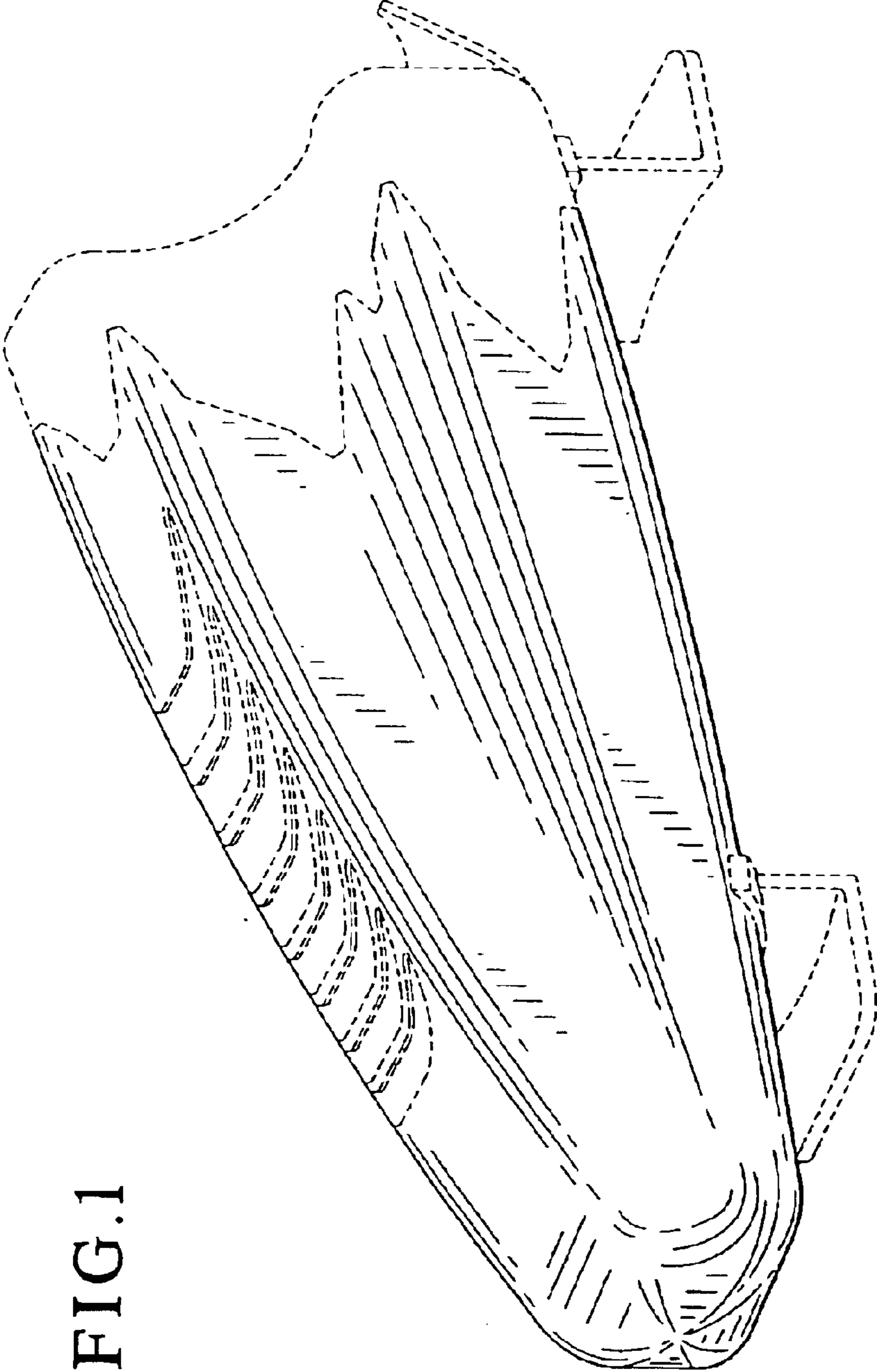

FIG.1

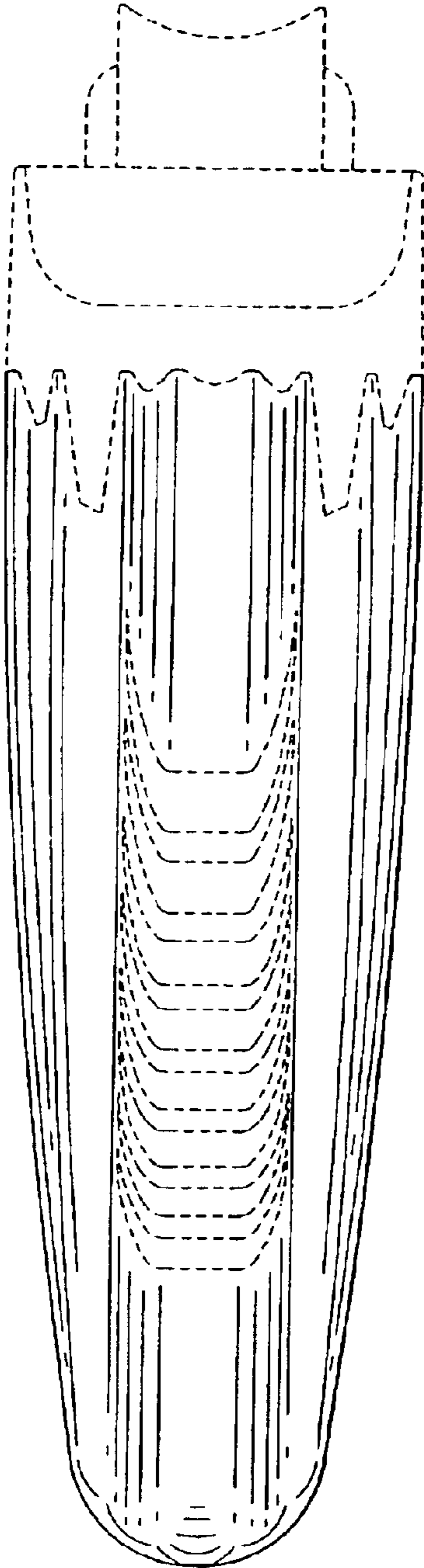

FIG. 2

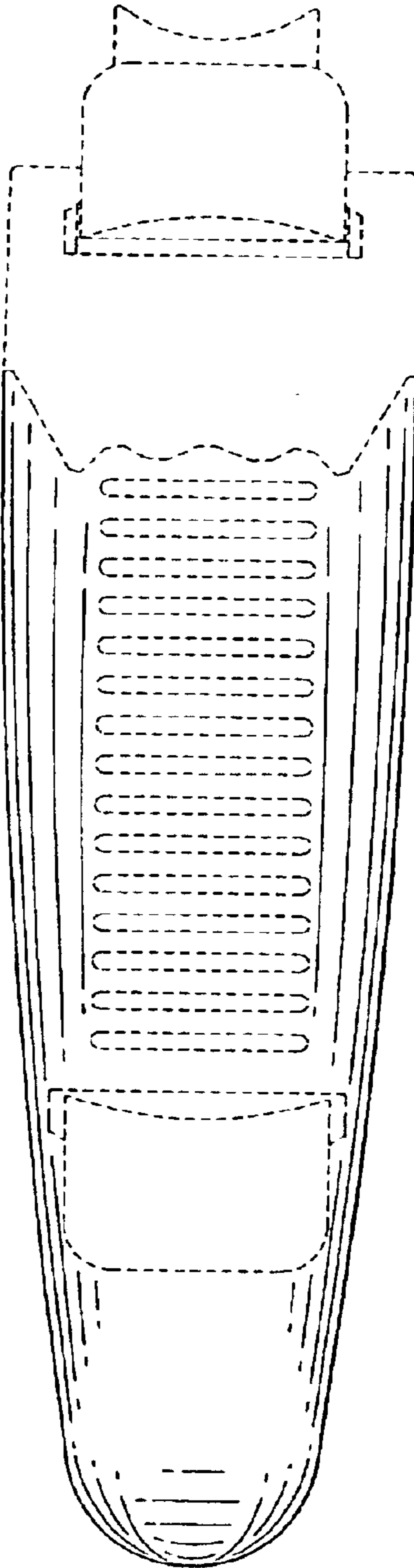

FIG. 3

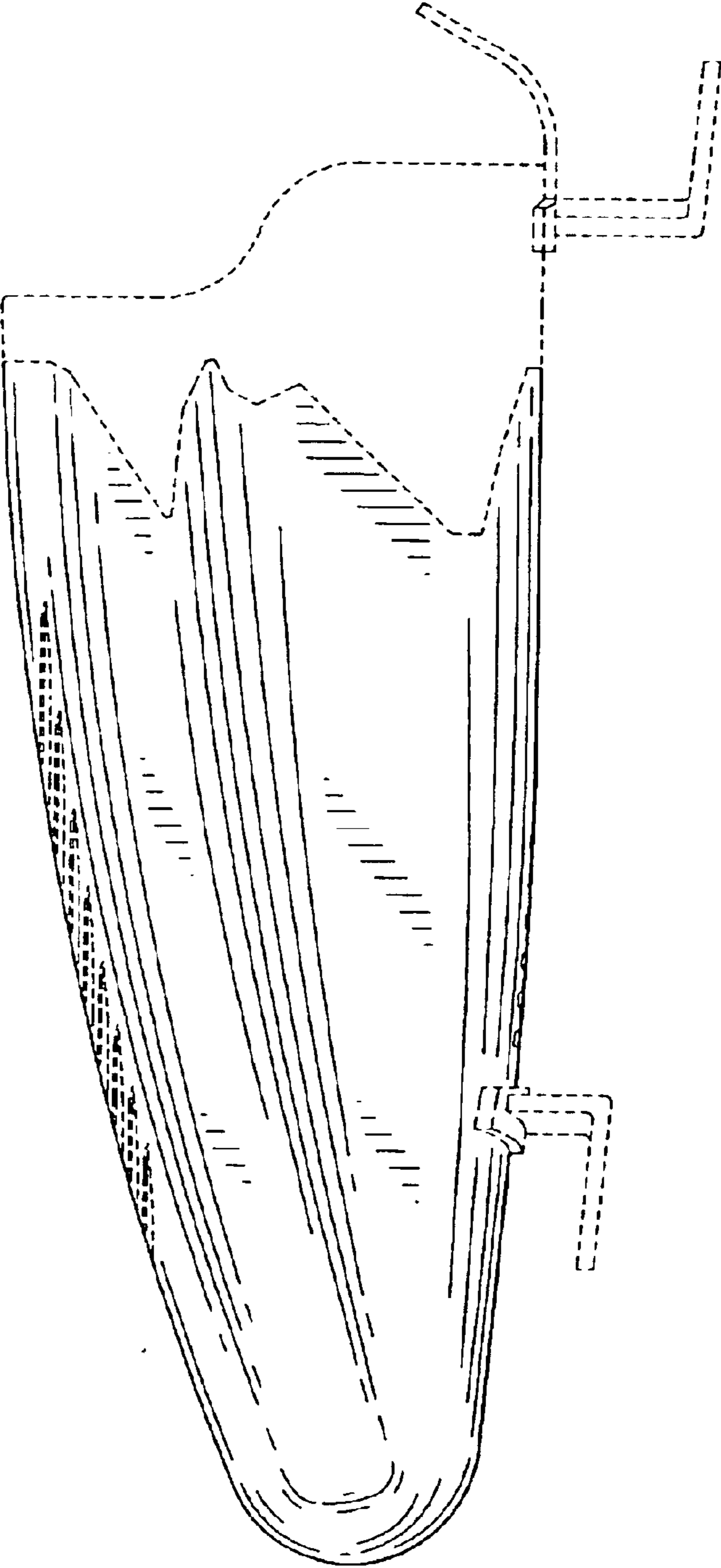

FIG. 4

FIG. 5

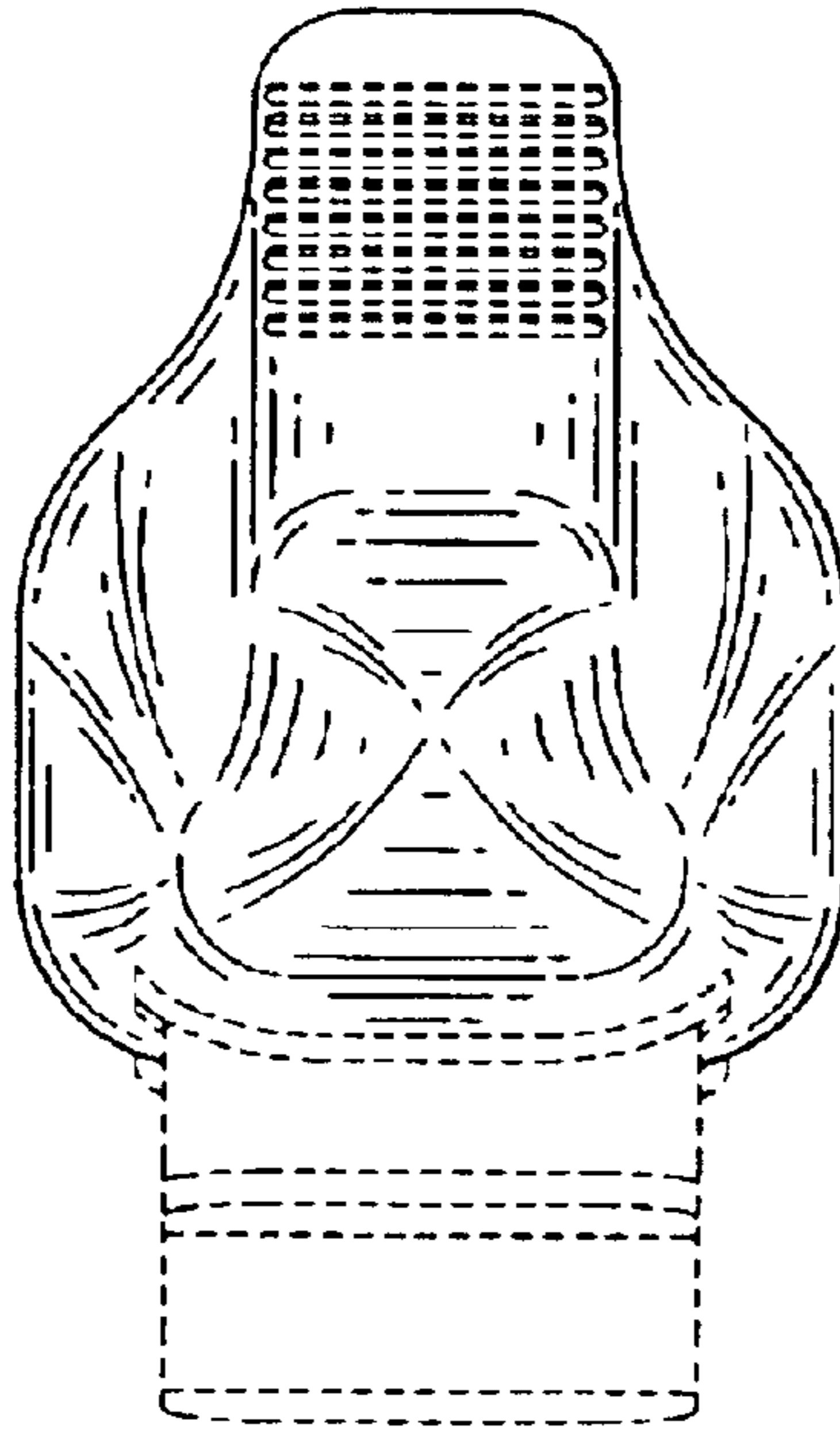
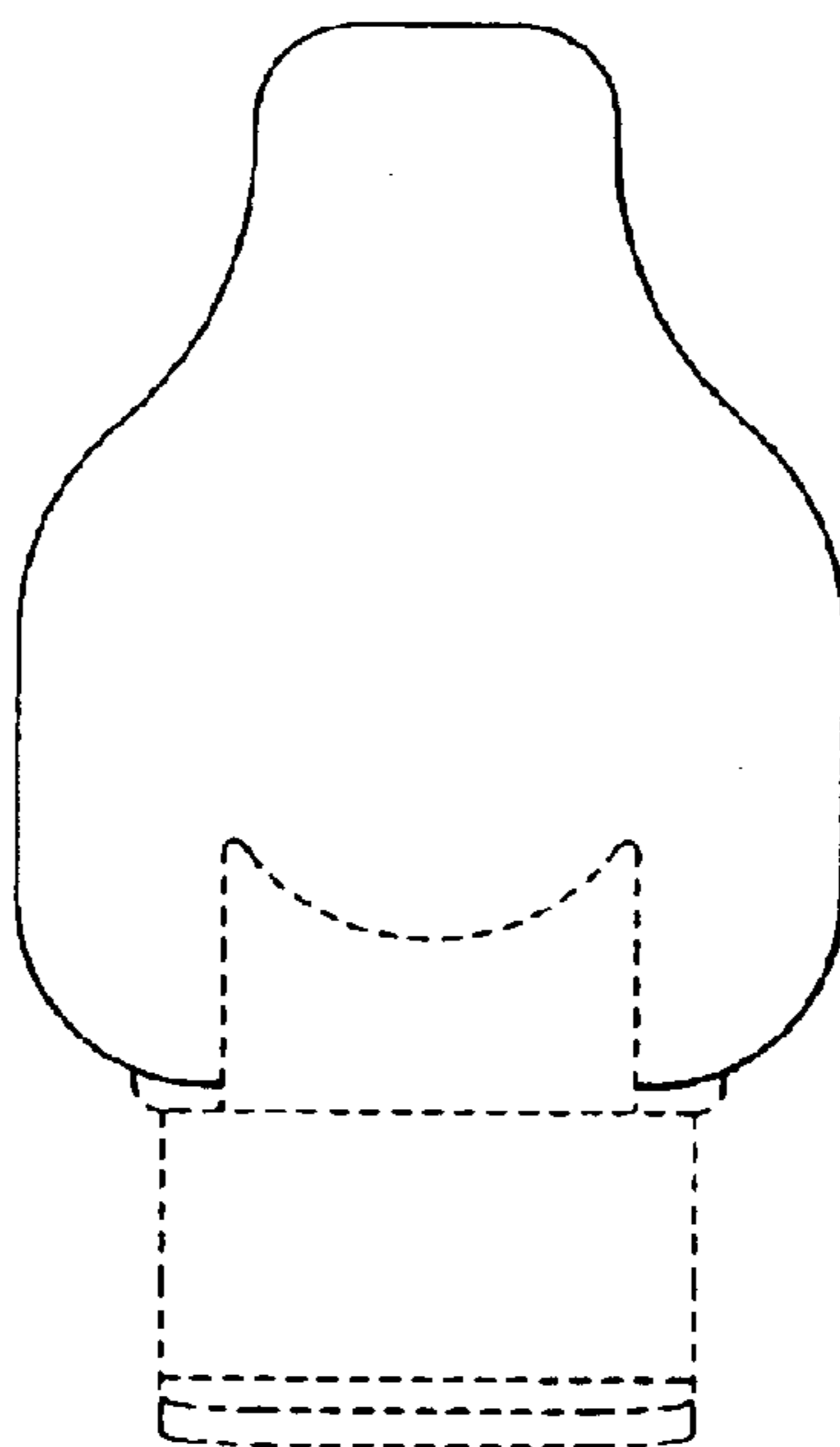

FIG. 6



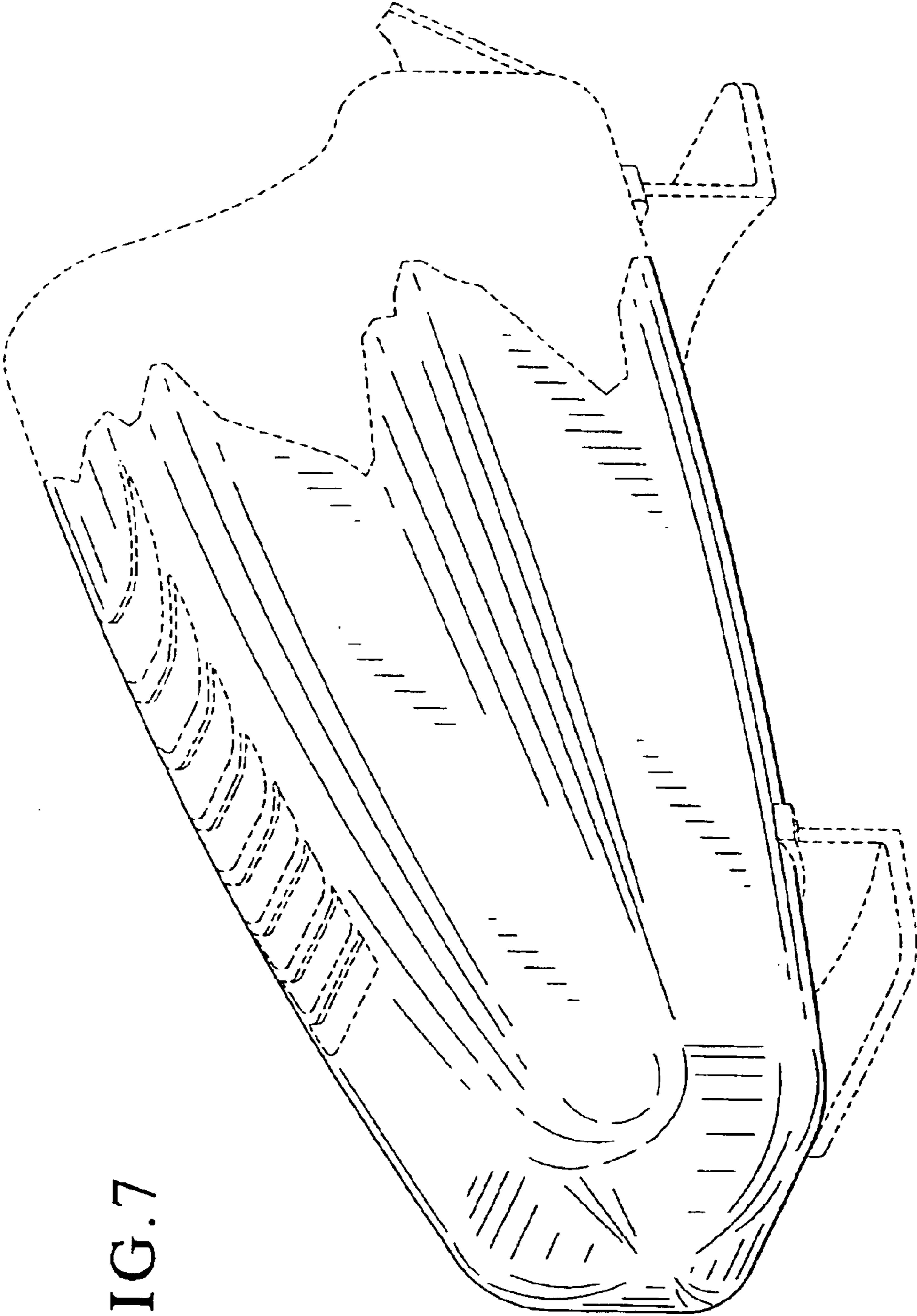

FIG. 7

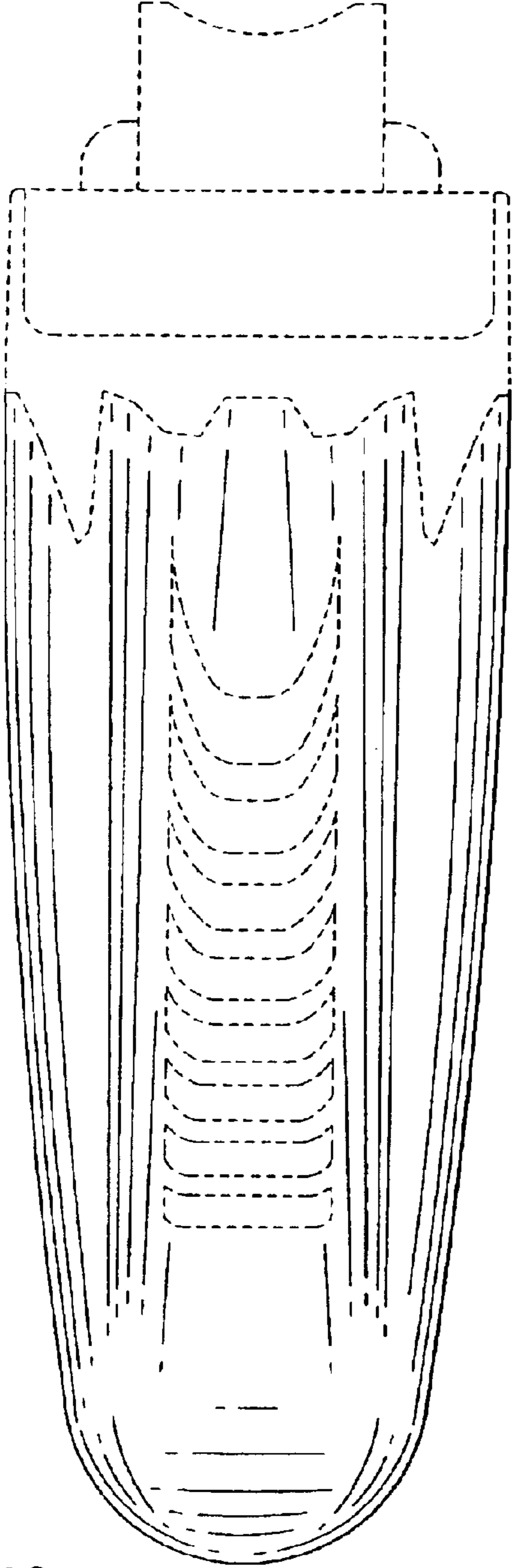

FIG. 8

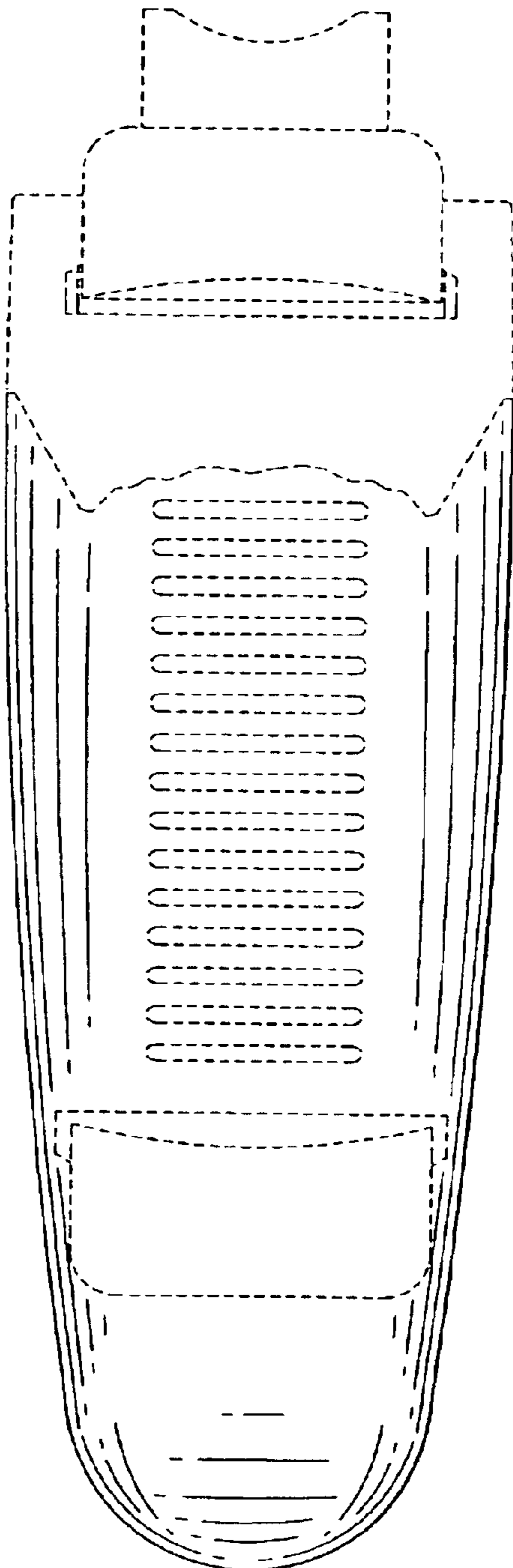

FIG. 9

FIG.10

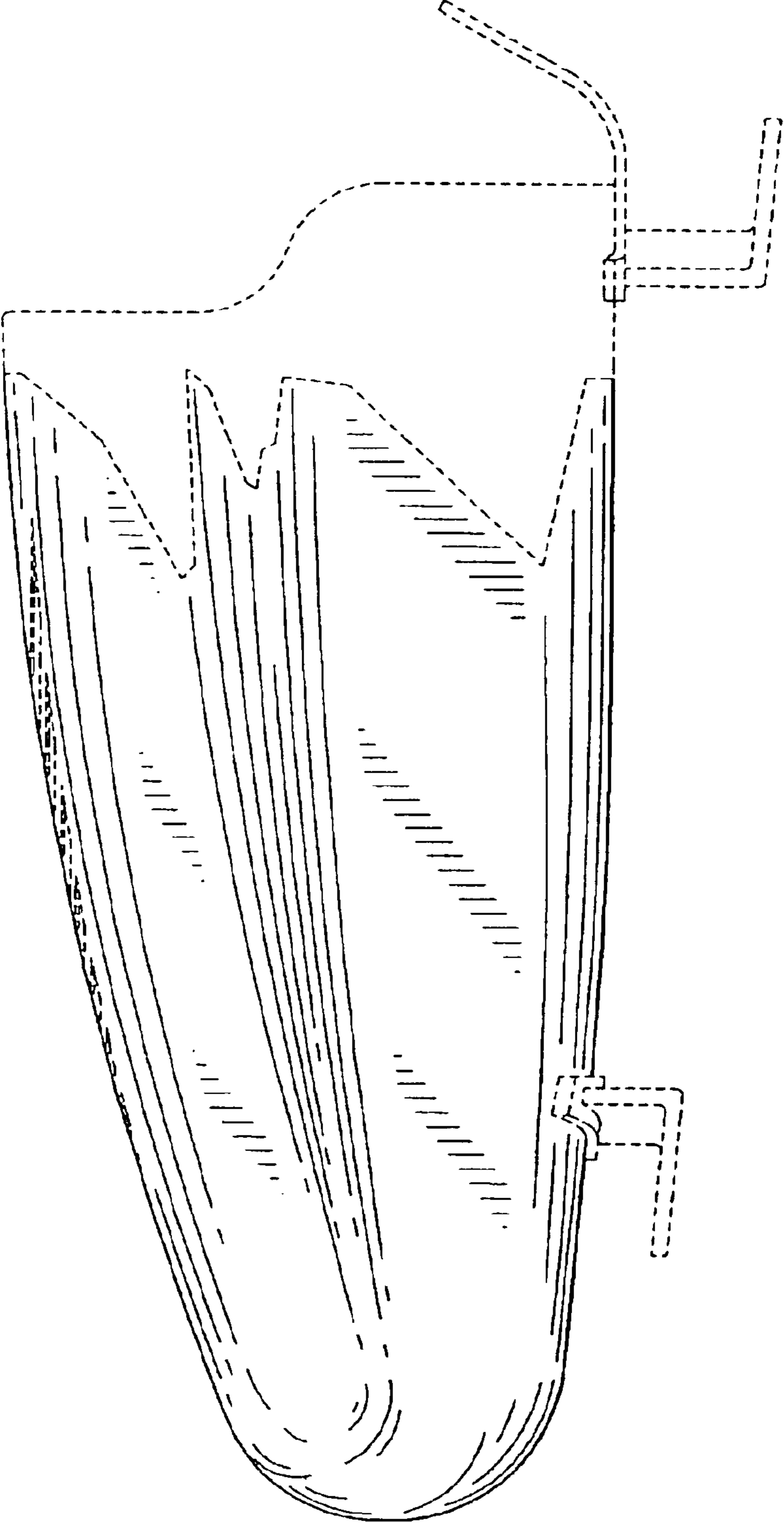

FIG. 11

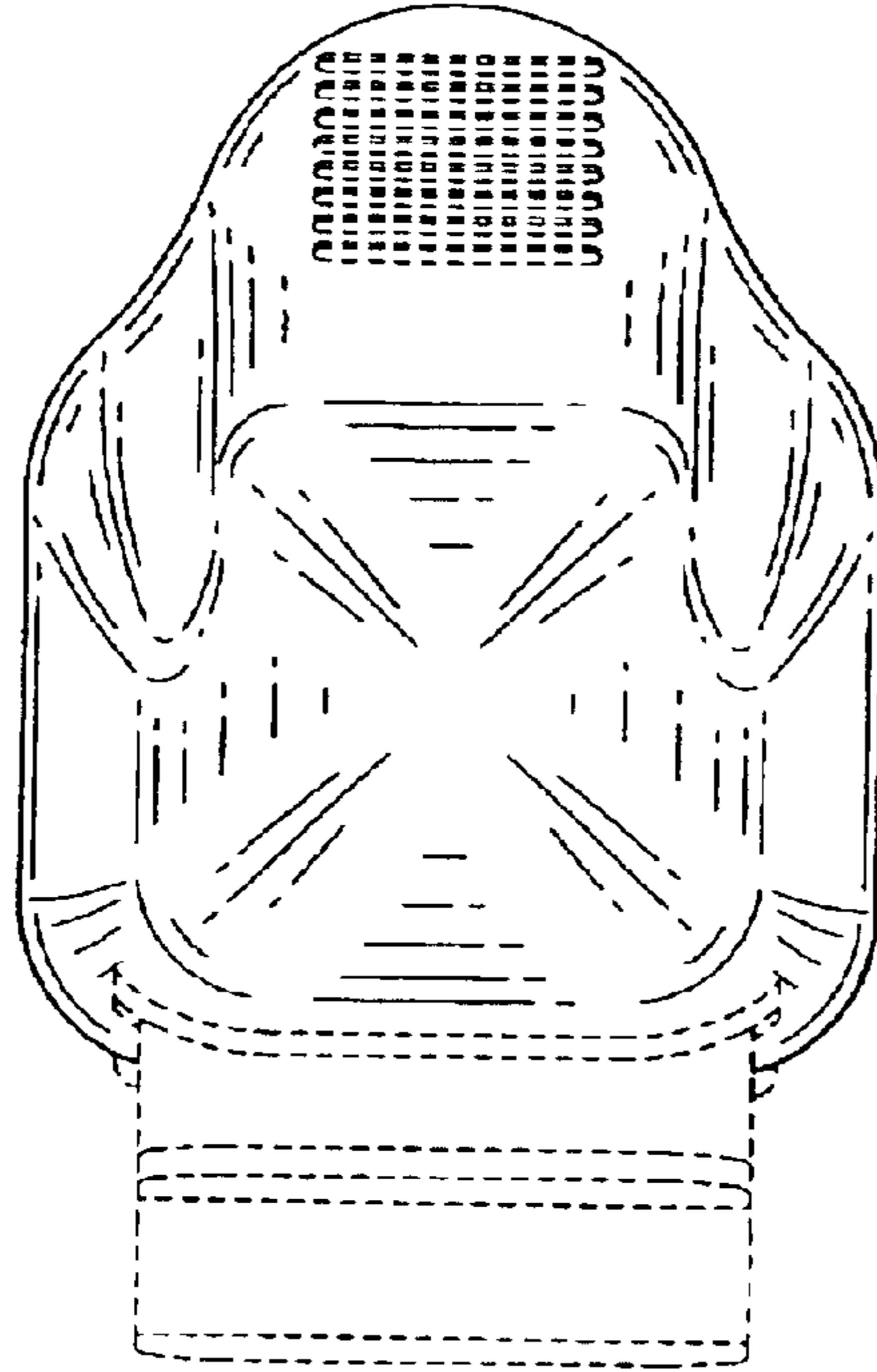

FIG. 12

