

US00D498467S

(12) **United States Design Patent**
Brogle et al.

(10) **Patent No.: US D498,467 S**

(45) **Date of Patent: ** Nov. 16, 2004**

(54) **LATCH FOR ELECTRONIC CARD
FACEPLATES**

6,646,883 B2 * 11/2003 Salinas 361/754

* cited by examiner

(75) Inventors: **John Brogle**, Lawrenceville, NJ (US);
Girard Sidone, Bordentown, NJ (US)

Primary Examiner—Brian N. Vinson

(74) *Attorney, Agent, or Firm*—Matthew J. Hodulik

(73) Assignee: **Lucent Technologies Inc.**, Murray Hill,
NJ (US)

(57) **CLAIM**

The ornamental design of a latch for electronic card face-
plates, as shown and described.

(**) Term: **14 Years**

DESCRIPTION

(21) Appl. No.: **29/143,225**

FIG. 1 is a perspective view of an embodiment of the latch
showing our new design;

(22) Filed: **Jun. 8, 2001**

FIG. 2 is a top plan perspective view thereof;

(51) **LOC (7) Cl.** **13-03**

FIG. 3 is a bottom plan view thereof;

(52) **U.S. Cl.** **D13/199**

FIG. 4 is a side view thereof; the opposite side being a mirror
image;

(58) **Field of Search** D13/184, 199,
D13/169; D14/299; 439/157, 159-160;
361/754, 801, 758, 752; 200/535

FIG. 5 is a front view thereof;

FIG. 6 is a rear view thereof;

FIG. 7 is a perspective view of another embodiment of the
latch showing our new design,

(56) **References Cited**

U.S. PATENT DOCUMENTS

- 6,185,106 B1 * 2/2001 Mueller 361/798
- 6,266,248 B1 * 7/2001 Hanas et al. 361/752
- 6,312,275 B1 * 11/2001 Tortorella 361/754
- 6,370,035 B1 * 4/2002 De Cecco et al. 361/754
- 6,373,713 B1 * 4/2002 Jensen et al. 361/754

FIG. 8 is a top plan view thereof;

FIG. 9 is a bottom plan view thereof;

FIG. 10 is a side view thereof; the opposite side being a
mirror image;

FIG. 11 is a front view thereof; and,

FIG. 12 is a rear view thereof.

1 Claim, 4 Drawing Sheets

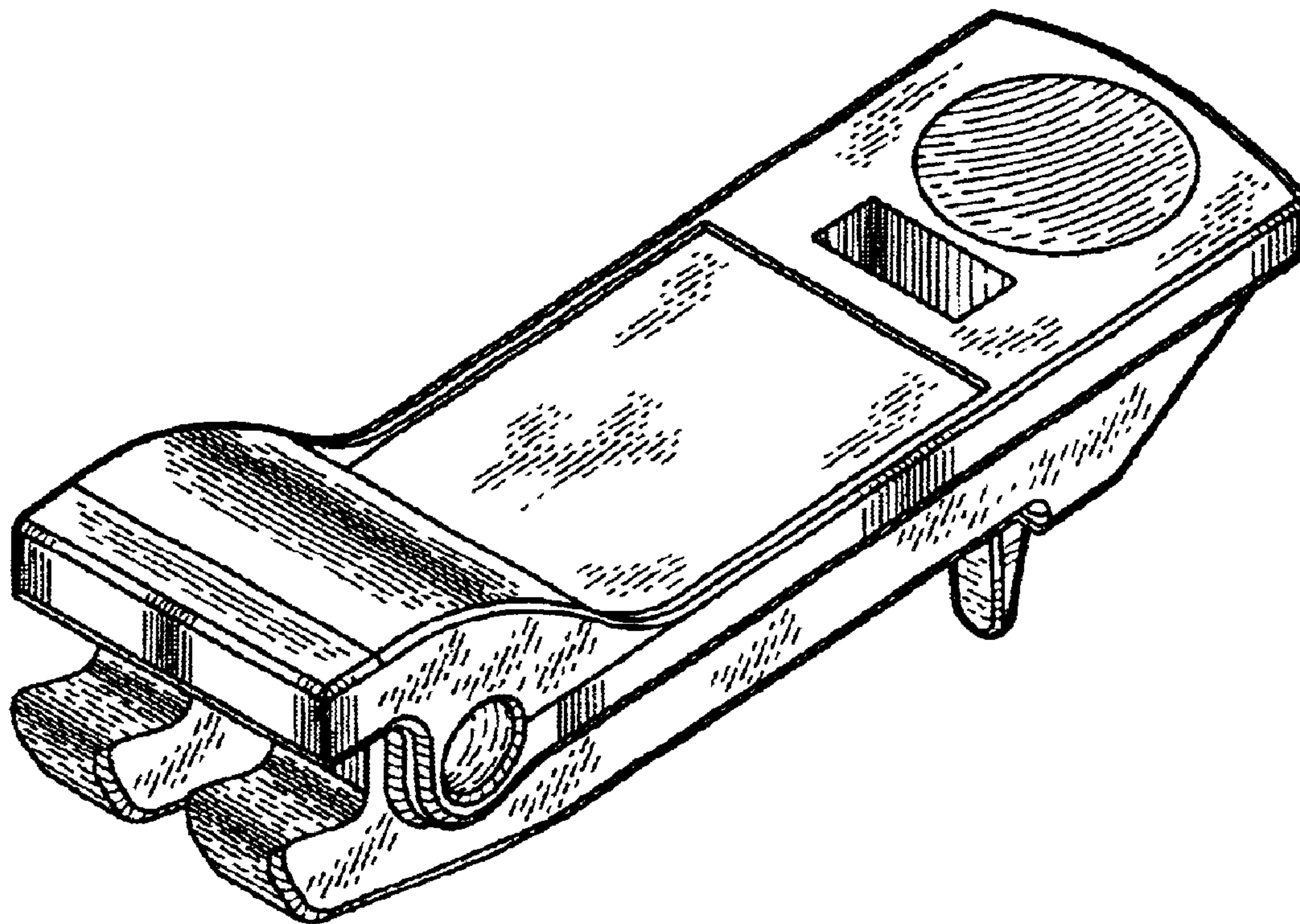

FIG. 1

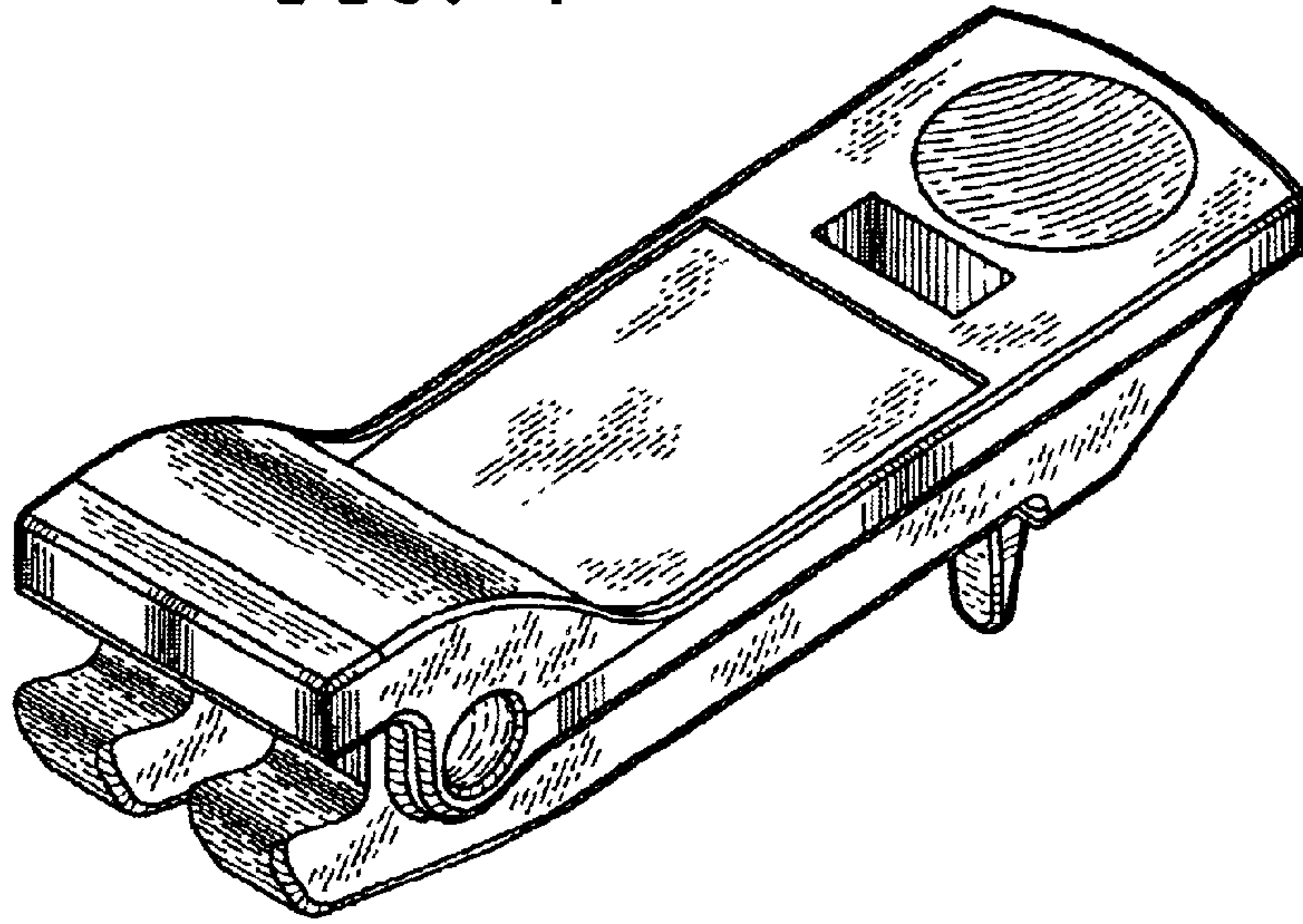

FIG. 2

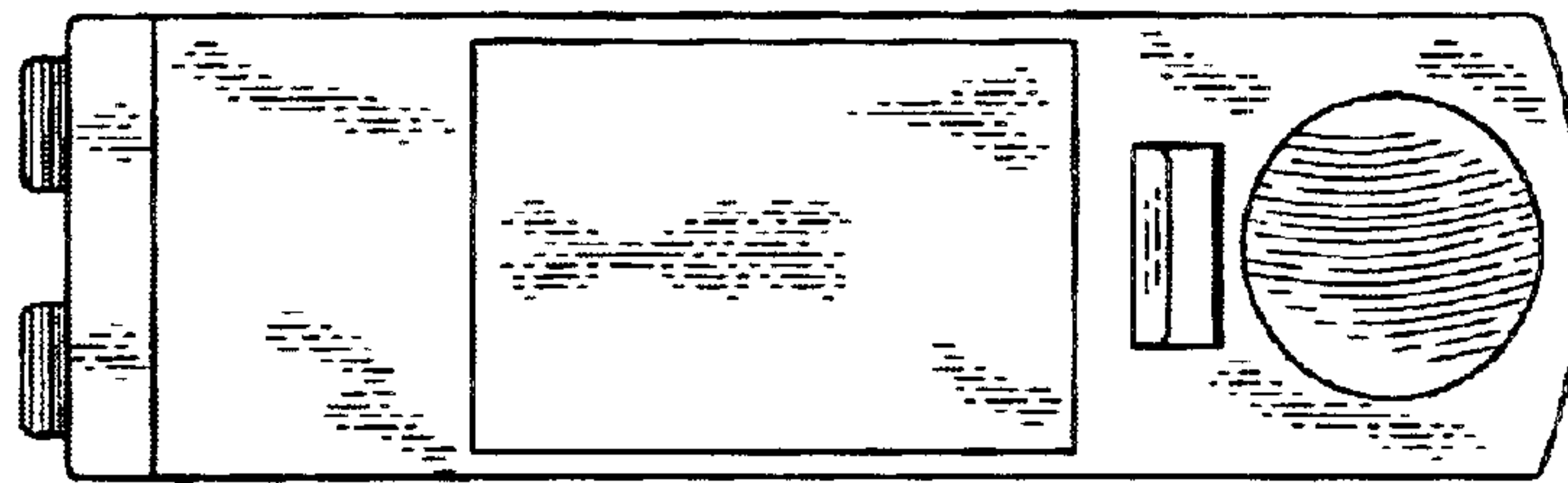

FIG. 3

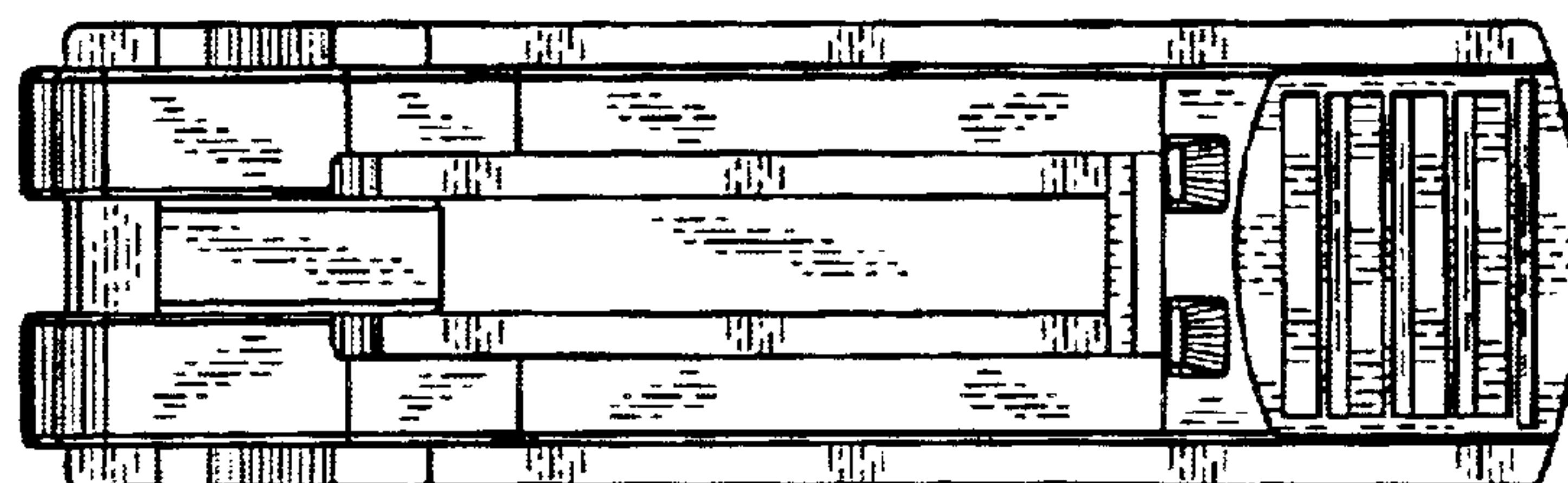

FIG. 4

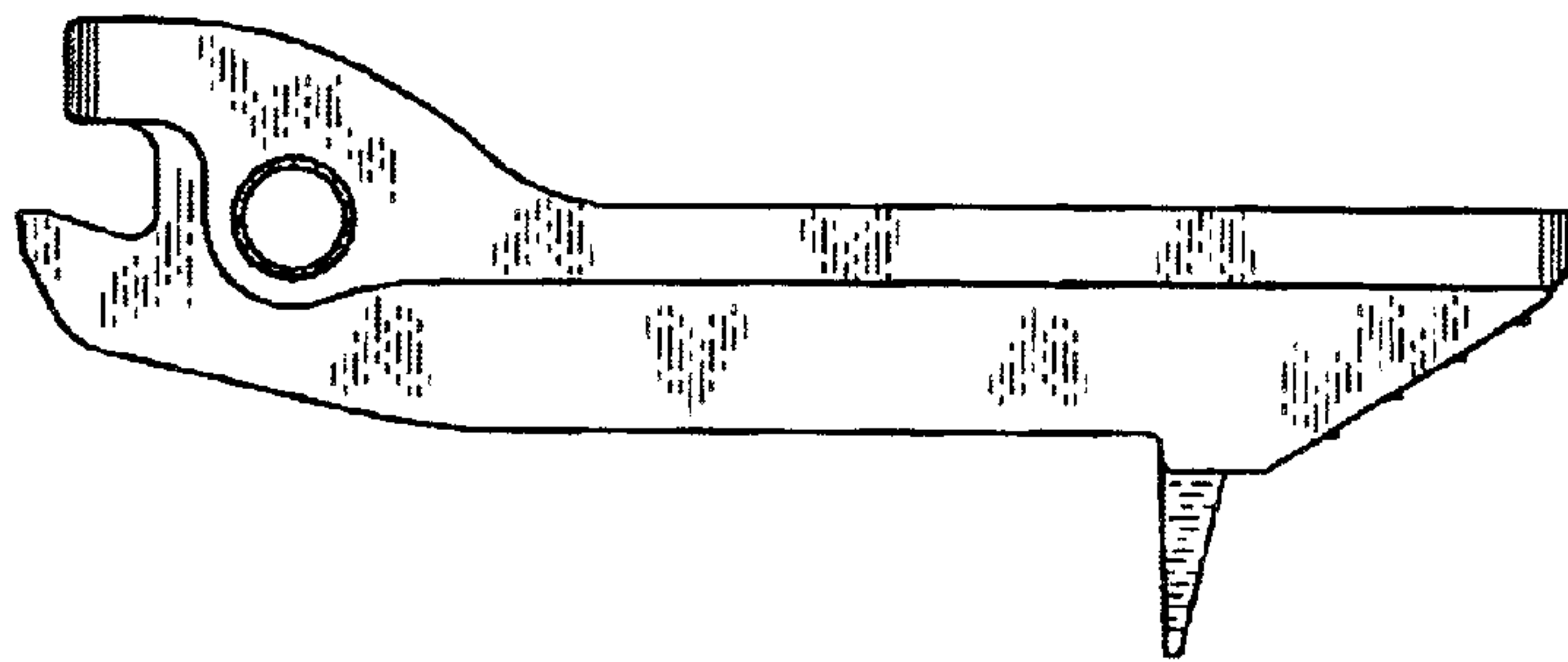

FIG. 5

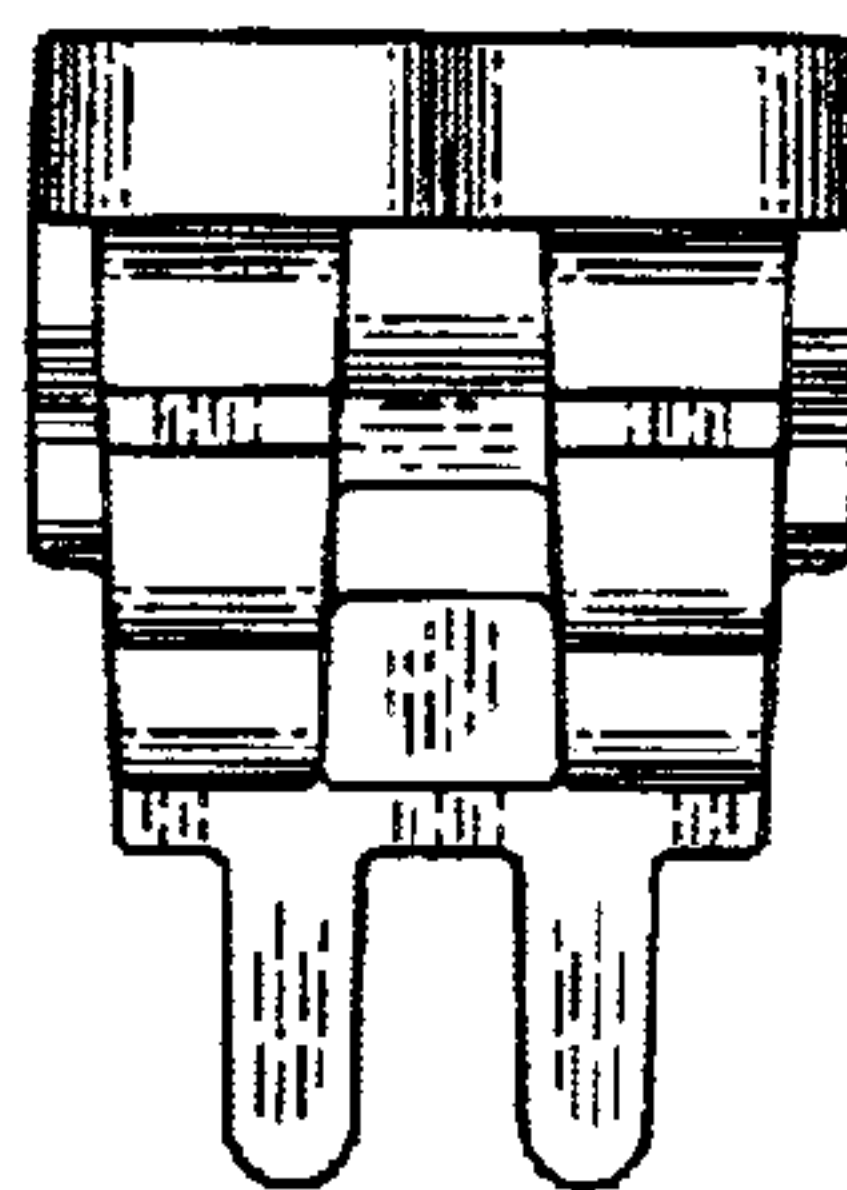

FIG. 6

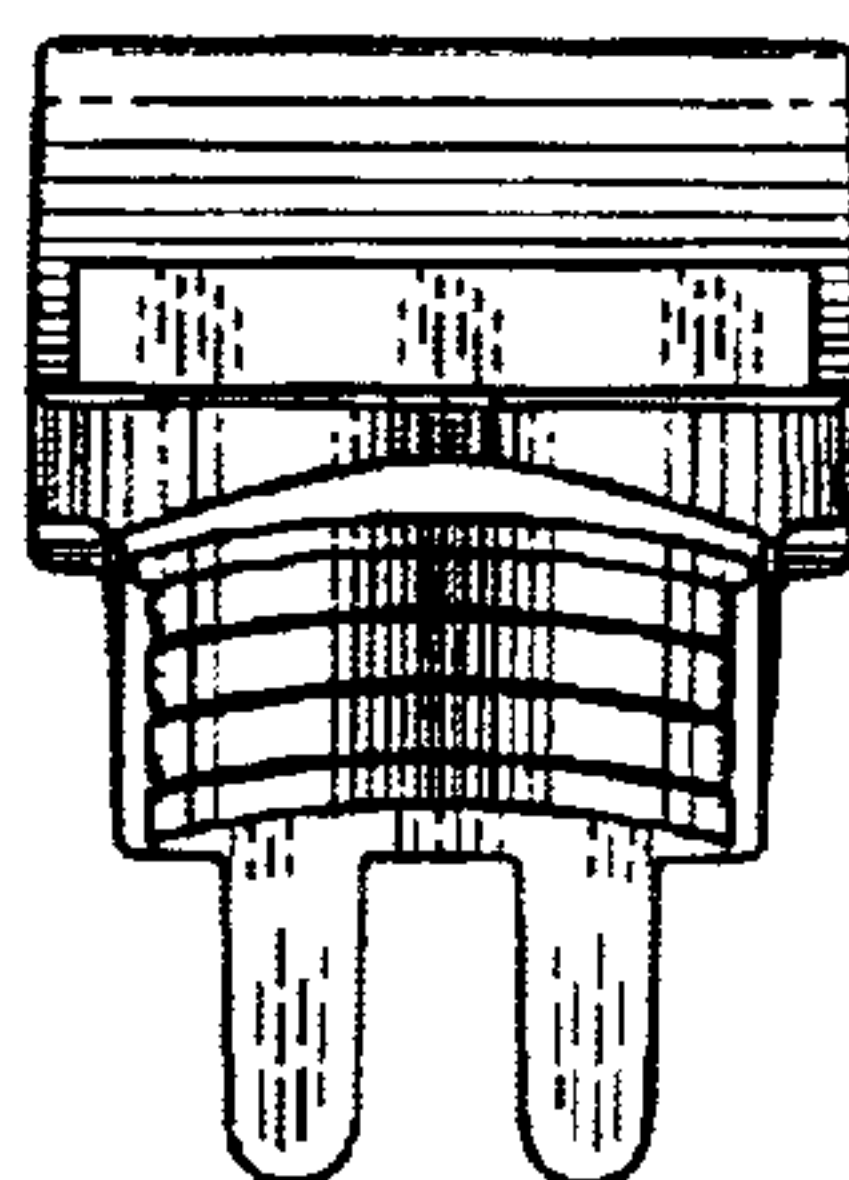

FIG. 7

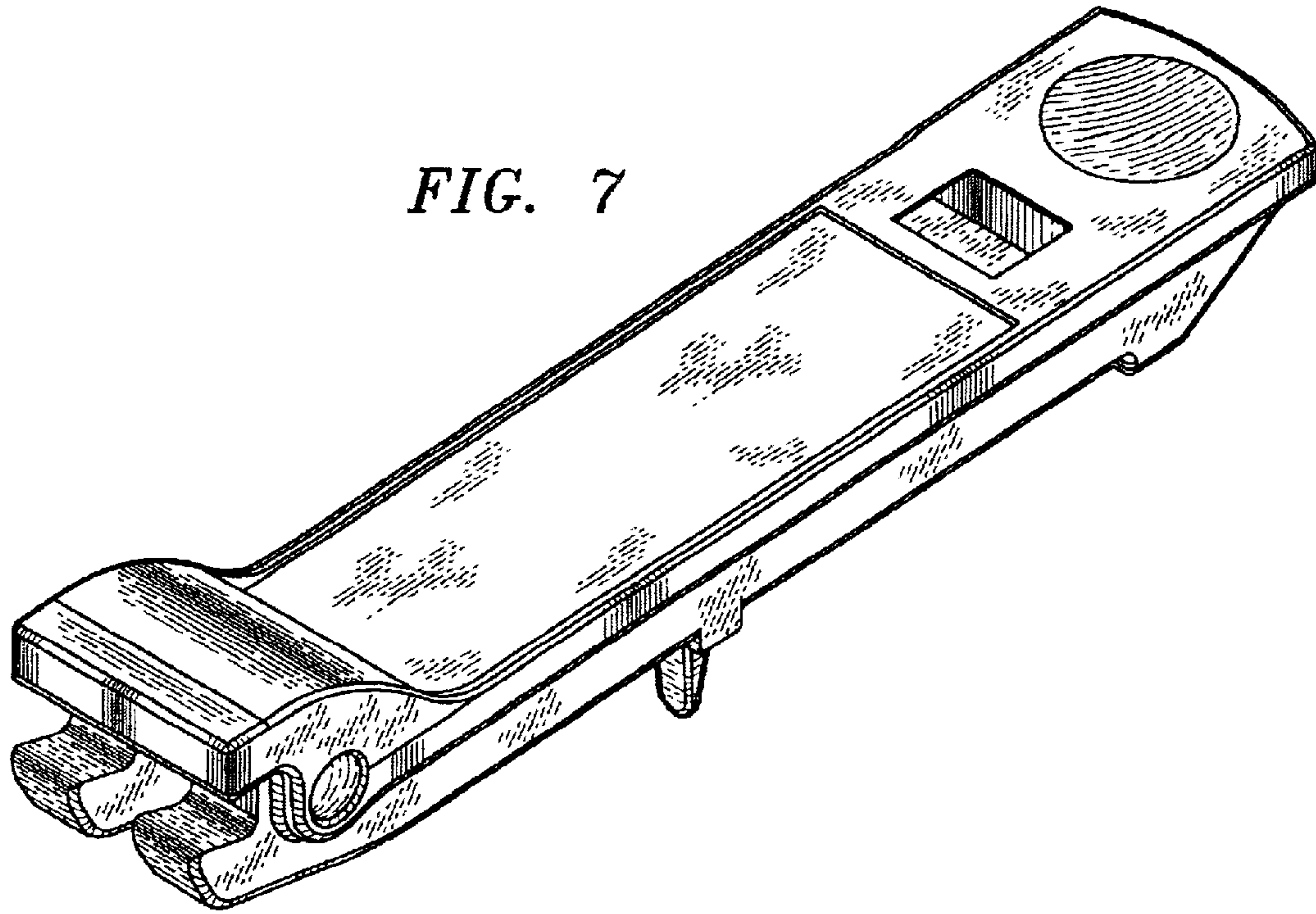

FIG. 8

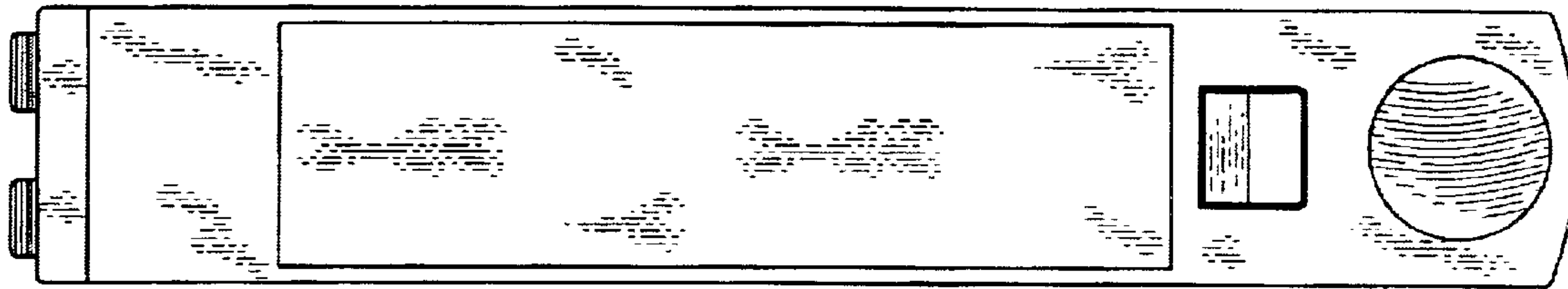

FIG. 9

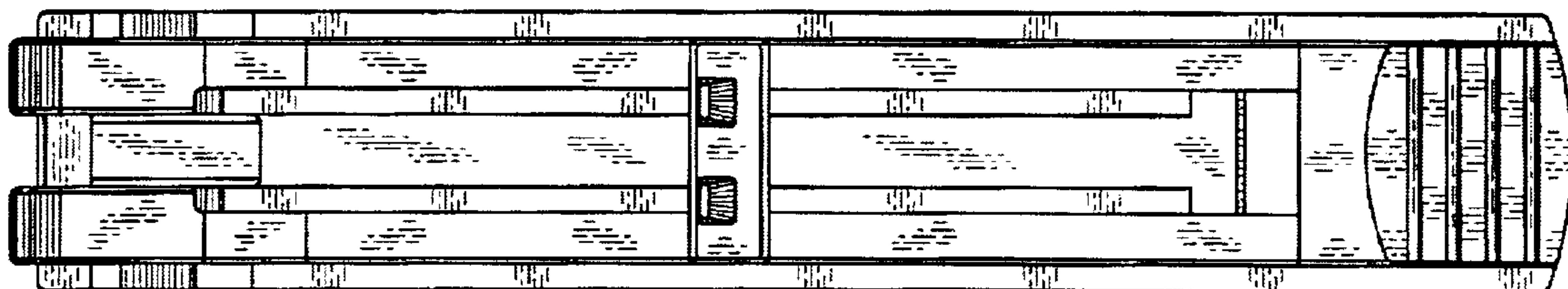

FIG. 10

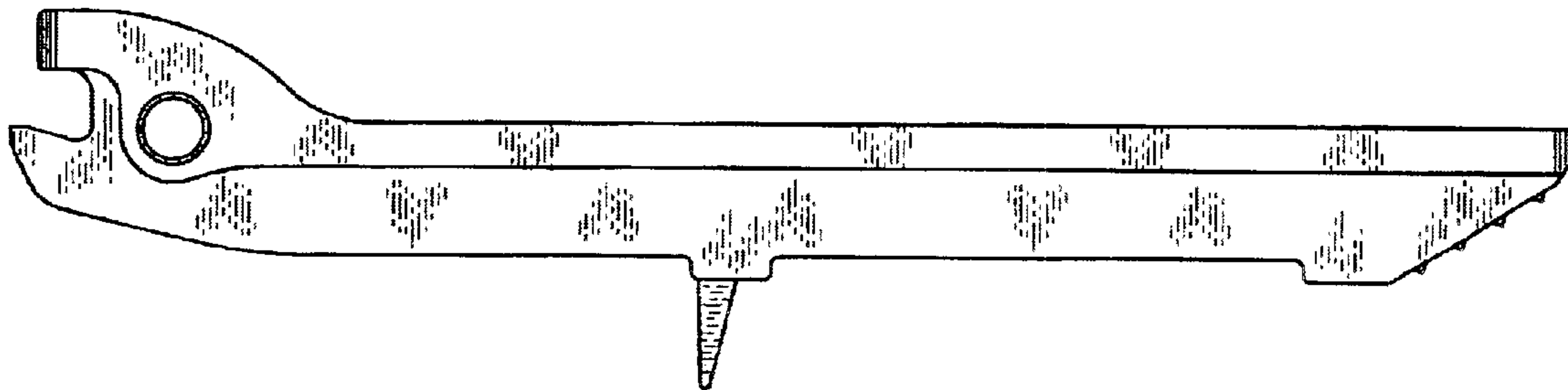

FIG. 11

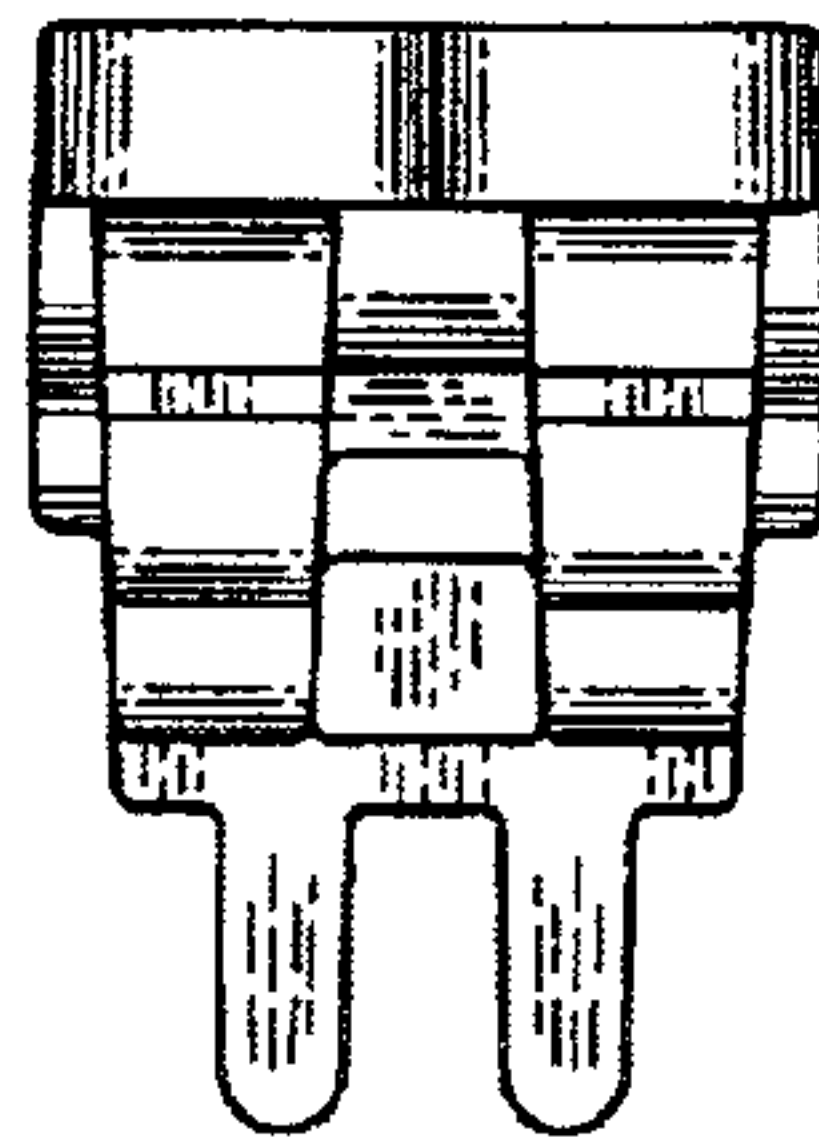

FIG. 12

