

US00D498412S

(12) **United States Design Patent** (10) **Patent No.:** **US D498,412 S**
Pehta et al. (45) **Date of Patent:** **** Nov. 16, 2004**

(54) **TABLE HEIGHT ADJUSTERS**

(76) Inventors: **John A. Pehta**, 2 Lancashire Dr.,
Princeton Junction, NJ (US) 08550;
Ann D. Pehta, 2 Lancashire Dr.,
Princeton Junction, NJ (US) 08550

(**) Term: **14 Years**

(21) Appl. No.: **29/182,929**

(22) Filed: **Jun. 4, 2003**

(51) **LOC (7) Cl.** **08-05**

(52) **U.S. Cl.** **D8/374**

(58) **Field of Search** D8/374; 248/188.2,
248/346.01, 346.02; 5/668, 663

(56) **References Cited**

U.S. PATENT DOCUMENTS

1,981,627	A	*	11/1934	Merriman	248/346.11
2,893,164	A	*	7/1959	Manatt	248/188.2
2,933,850	A	*	4/1960	Manatt	248/188.2
D404,992	S	*	2/1999	Sittig	D8/374
D423,340	S	*	4/2000	Sittig	D8/374

* cited by examiner

Primary Examiner—Holly Baynham

(74) *Attorney, Agent, or Firm*—Robert J. Bird

(57) **CLAIM**

The ornamental design for a set of table height adjusters, as shown and described.

DESCRIPTION

Reference is hereby made to our related and copending Application Ser. No. 09/967,701 which was filed on Oct. 1, 2001.

FIG. 1 is an exploded perspective view of a single three-part table height adjuster, of our new design.

FIG. 2 is a reduced view of our table height adjusters in use, with top members only.

FIG. 3 similarly shows our table height adjusters, with stacked top and bottom members.

FIG. 4 similarly shows our table height adjusters, with stacked top, middle, and bottom members.

FIG. 5 is an enlarged top view of the top member shown in FIG. 1; and,

FIG. 6 is a sectional elevation view of top, middle, and bottom members stacked together.

The table height adjusters are shown in use, at three different adjustments, in FIGS. 2–4 for clarity of illustration. The broken-line showing of tables in FIGS. 2–4 is for illustrative purposes only, and forms no part of the claimed design.

1 Claim, 3 Drawing Sheets

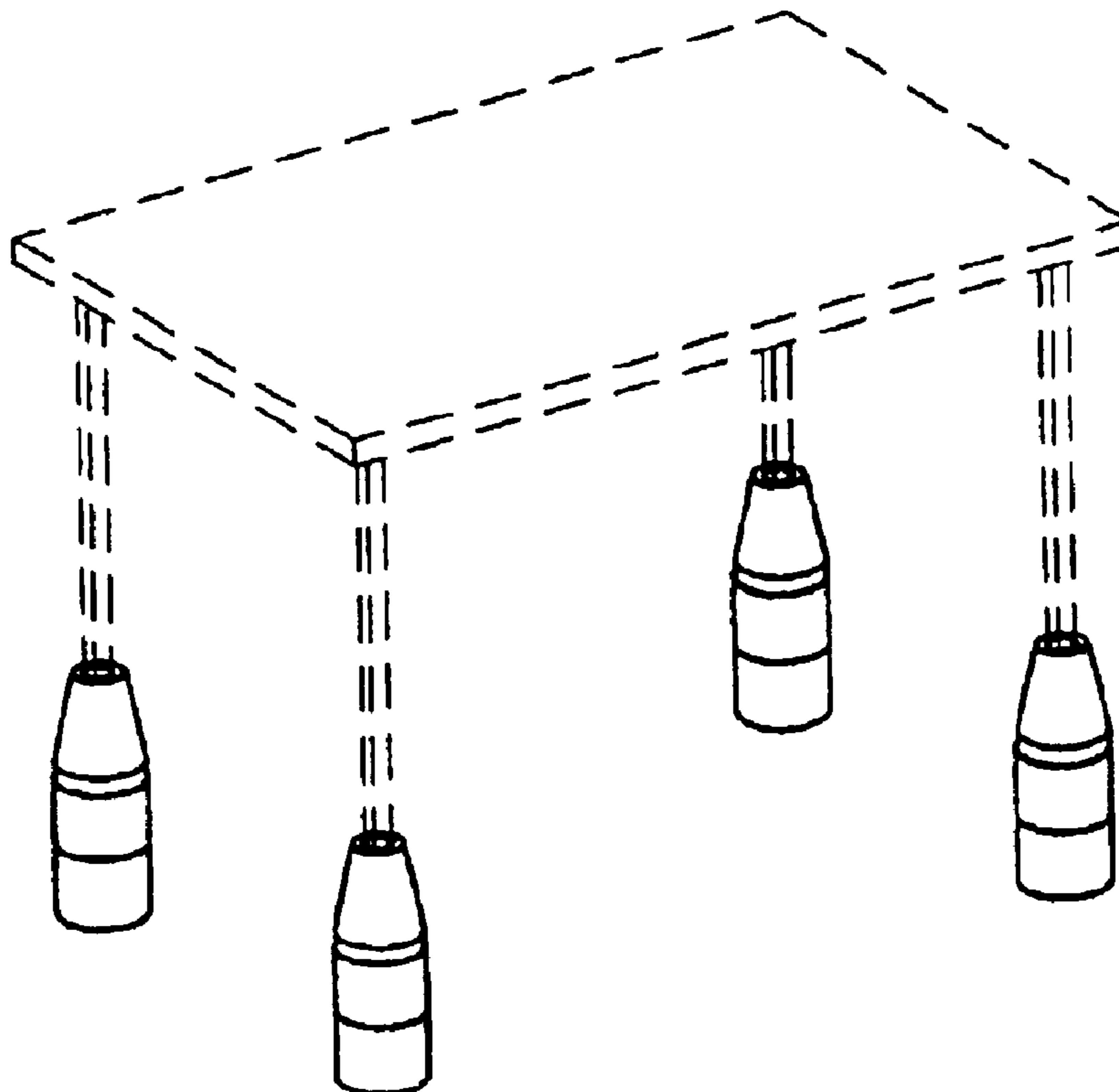

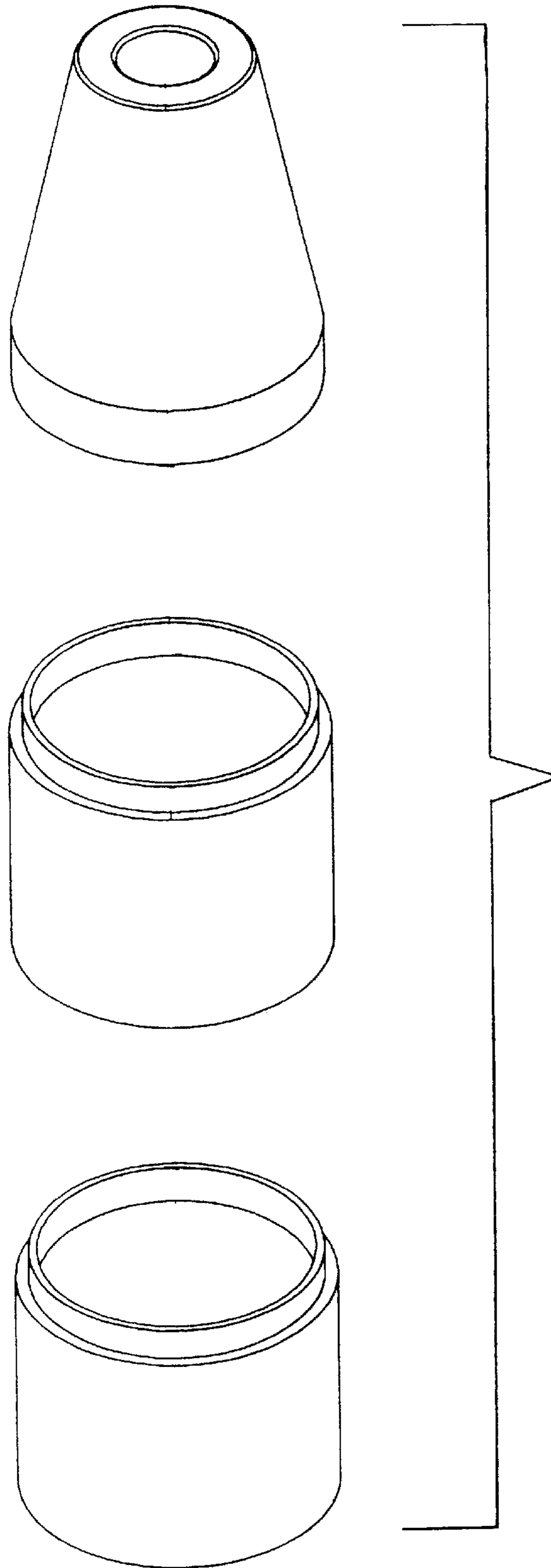

FIG. 1

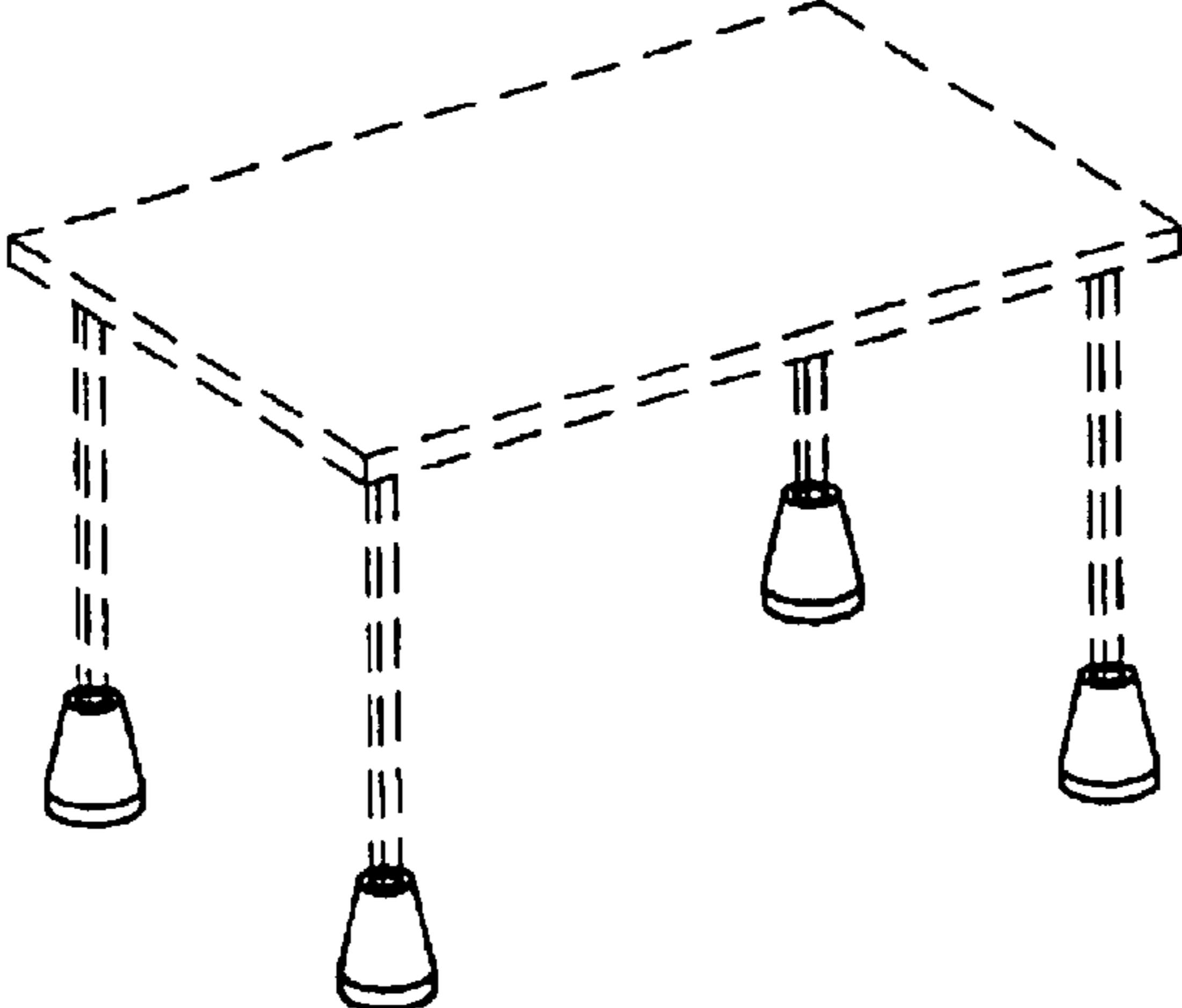

FIG. 2

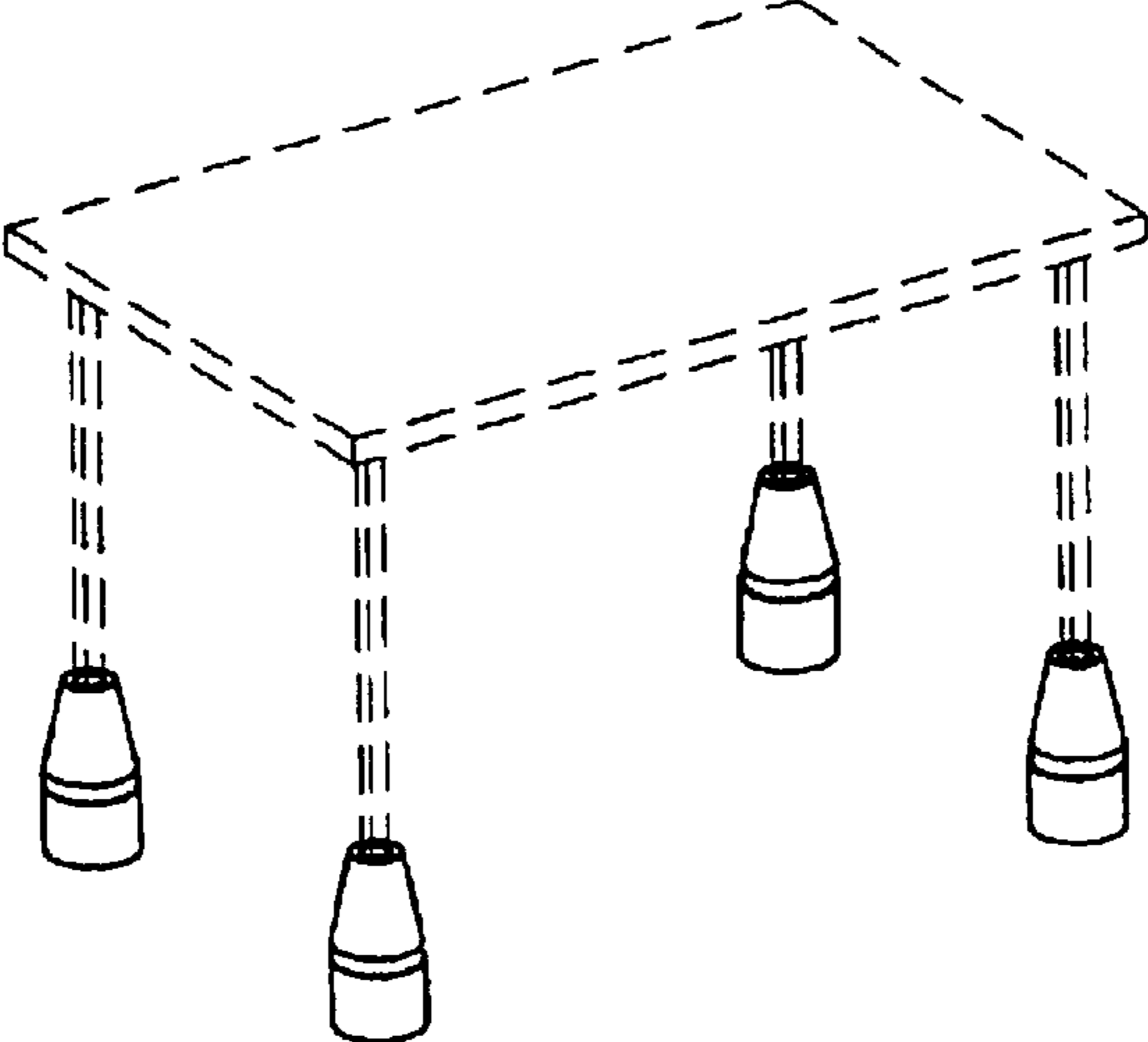

FIG. 3

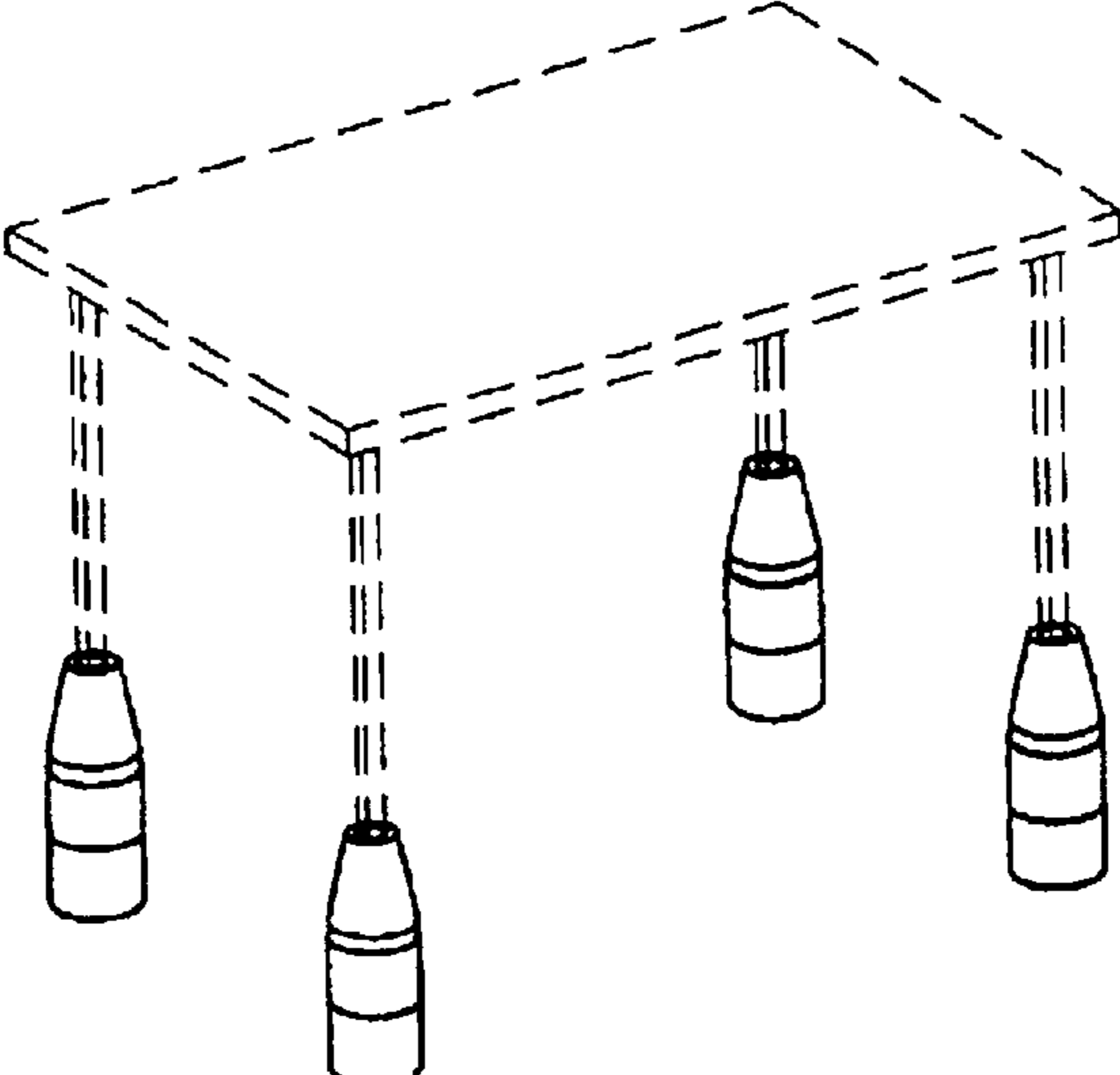

FIG. 4

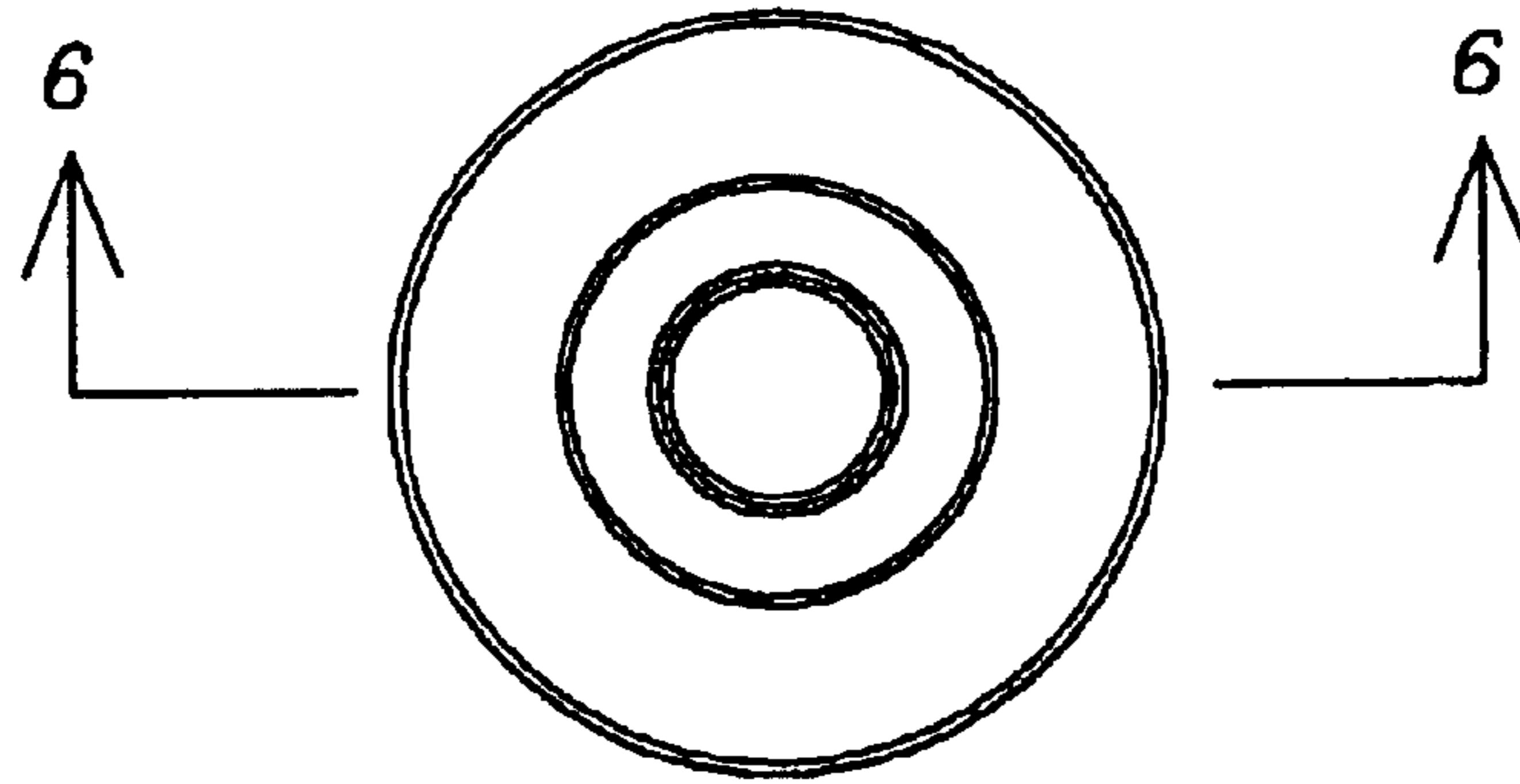

FIG. 5

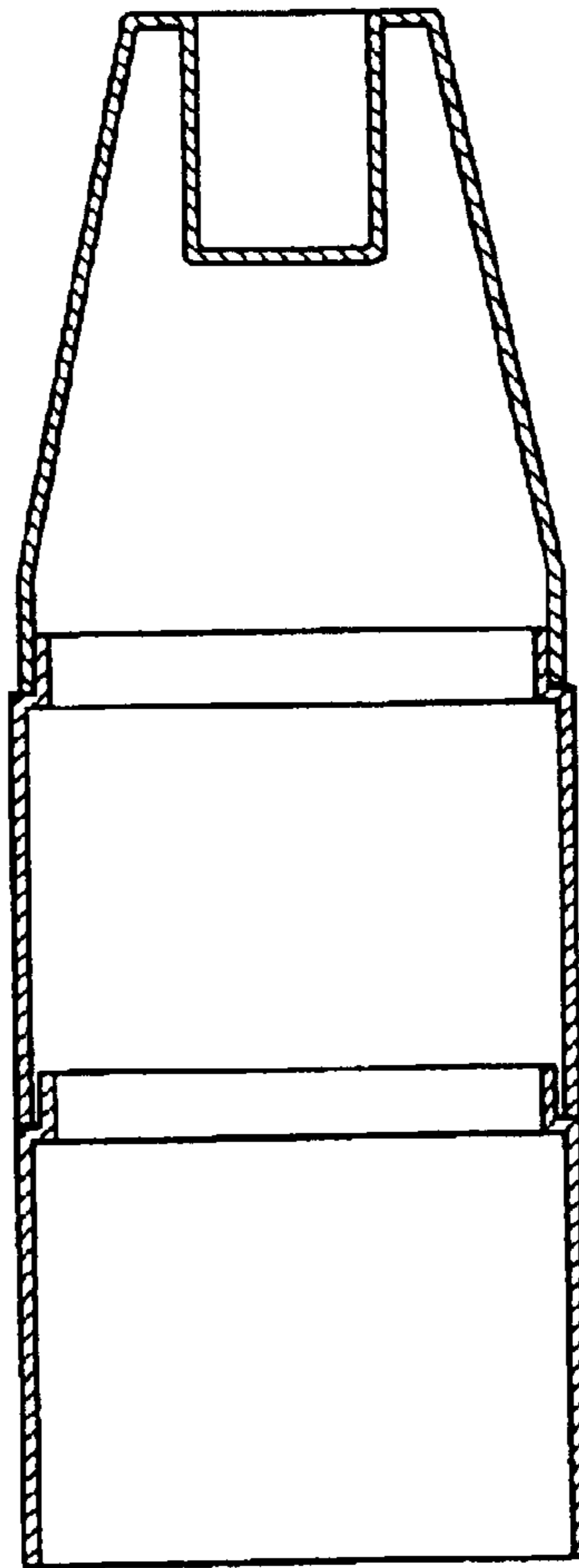

FIG. 6