

US00D498381S

(12) **United States Design Patent**  
**Graves et al.**

(10) **Patent No.:** **US D498,381 S**

(45) **Date of Patent:** **\*\* Nov. 16, 2004**

(54) **DOUBLE TOWEL BAR ARM**

(75) Inventors: **Michael Graves**, Princeton, NJ (US);  
**Donald Strum**, Princeton, NJ (US);  
**William Harrington**, Princeton, NJ  
(US); **Scott Doty**, Cranbury, NJ (US)

(73) Assignee: **Masco Corporation of Indiana**,  
Indianapolis, IN (US)

(\*\*) Term: **14 Years**

(21) Appl. No.: **29/185,369**

(22) Filed: **Jun. 26, 2003**

(51) **LOC (7) Cl.** ..... **06-04**

(52) **U.S. Cl.** ..... **D6/550**

(58) **Field of Search** ..... D6/546-550, 518-519,  
D6/522-524; D8/300, 303, 315-321, 354,  
363, 373, 380; 108/28-29; 211/13.1, 16,  
60.1, 86.01, 87.01, 88.01, 88.04, 100, 105.1-105.2,  
123, 126.1, 133.6, 134, 181.1, 182; 248/175,  
176.1, 200, 251, 302, 309.1; 16/110.1,  
412, 415; 242/570, 590, 595-598; 206/389,  
557

(56) **References Cited**

**U.S. PATENT DOCUMENTS**

D453,649 S \* 2/2002 Hoernig ..... D6/548

D453,887 S \* 2/2002 Meck et al. .... D6/548  
D477,485 S \* 7/2003 Hoernig ..... D6/548  
D477,737 S \* 7/2003 Hoernig ..... D6/548  
D492,528 S \* 7/2004 Graves et al. .... D6/548

\* cited by examiner

*Primary Examiner*—Brian N Vinson

(74) *Attorney, Agent, or Firm*—Kwadjo Adusei-Poku;  
Lloyd D. Doigan

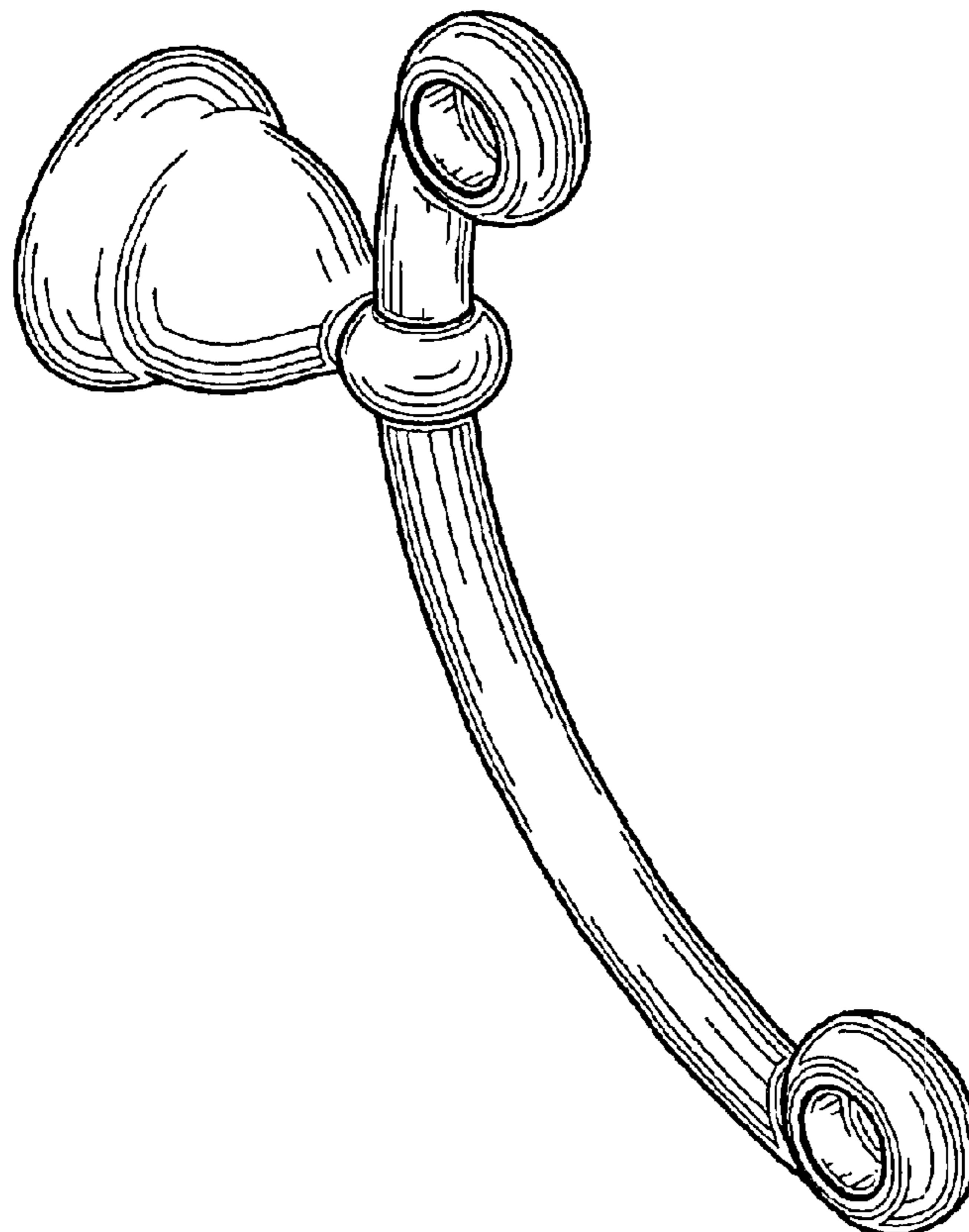
(57) **CLAIM**

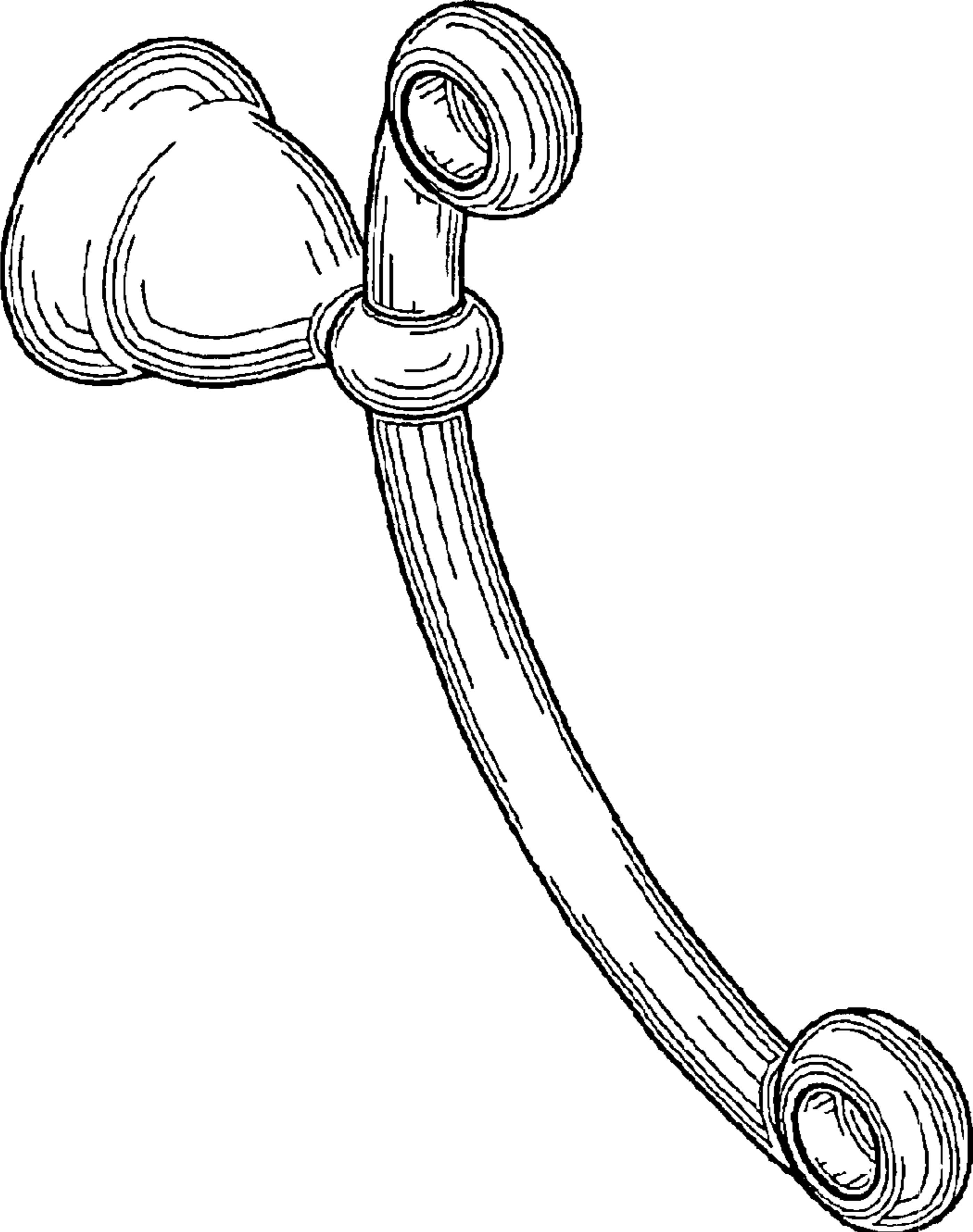
The ornamental design for a double towel bar arm, as shown  
and described.

**DESCRIPTION**

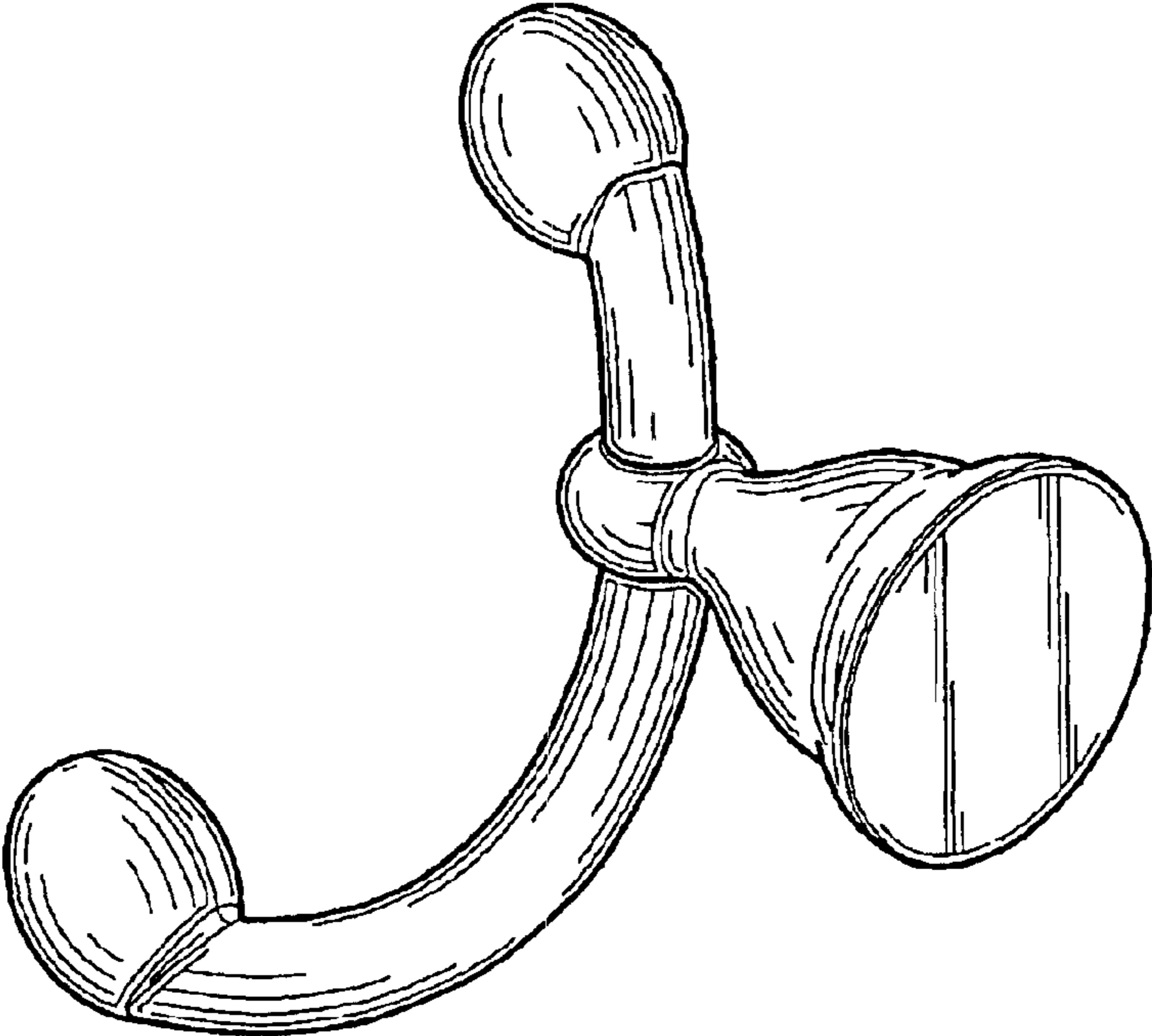
FIG. 1 is a front perspective view of a double towel bar arm  
showing our new design;  
FIG. 2 is a rear perspective view thereof;  
FIG. 3 is a right side elevational view thereof;  
FIG. 4 is a top plan view thereof;  
FIG. 5 is a left side elevational view thereof;  
FIG. 6 is a bottom plan view thereof;  
FIG. 7 is a front elevational view thereof; and,  
FIG. 8 is a rear elevational view thereof.

**1 Claim, 4 Drawing Sheets**

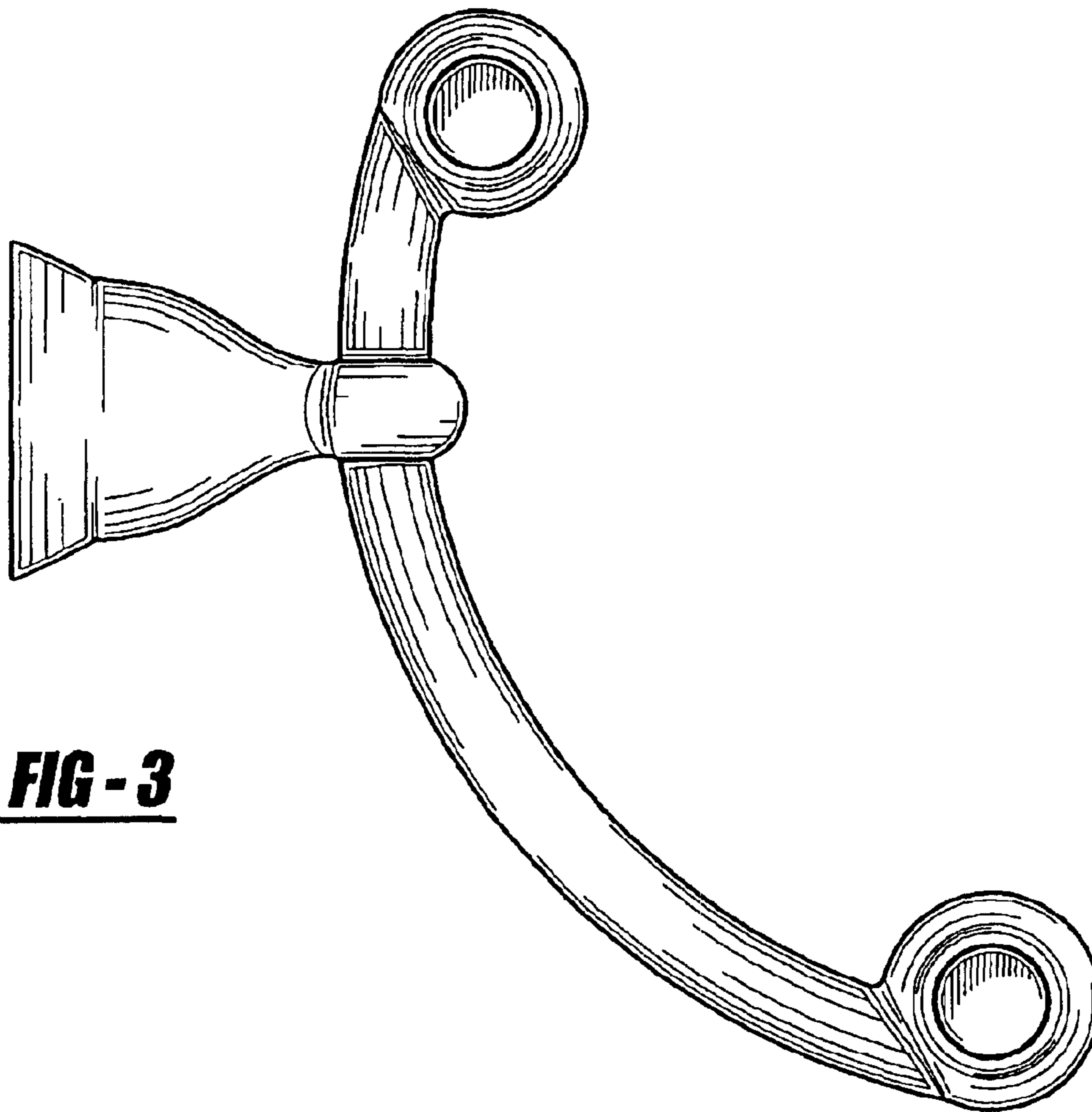




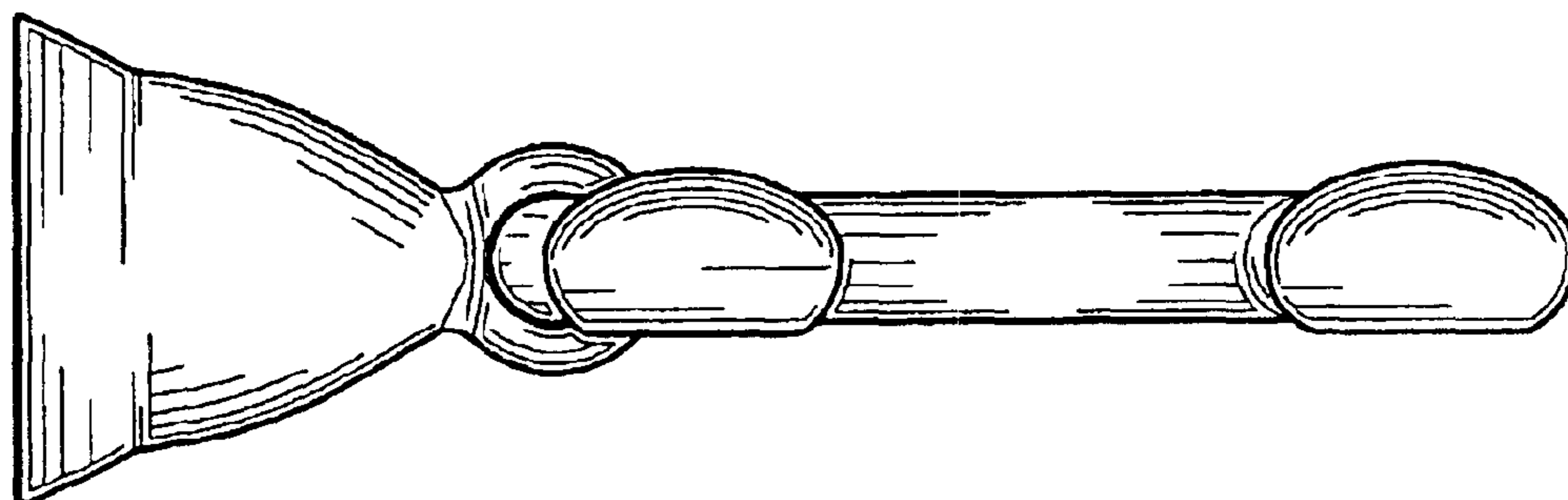
**FIG-1**



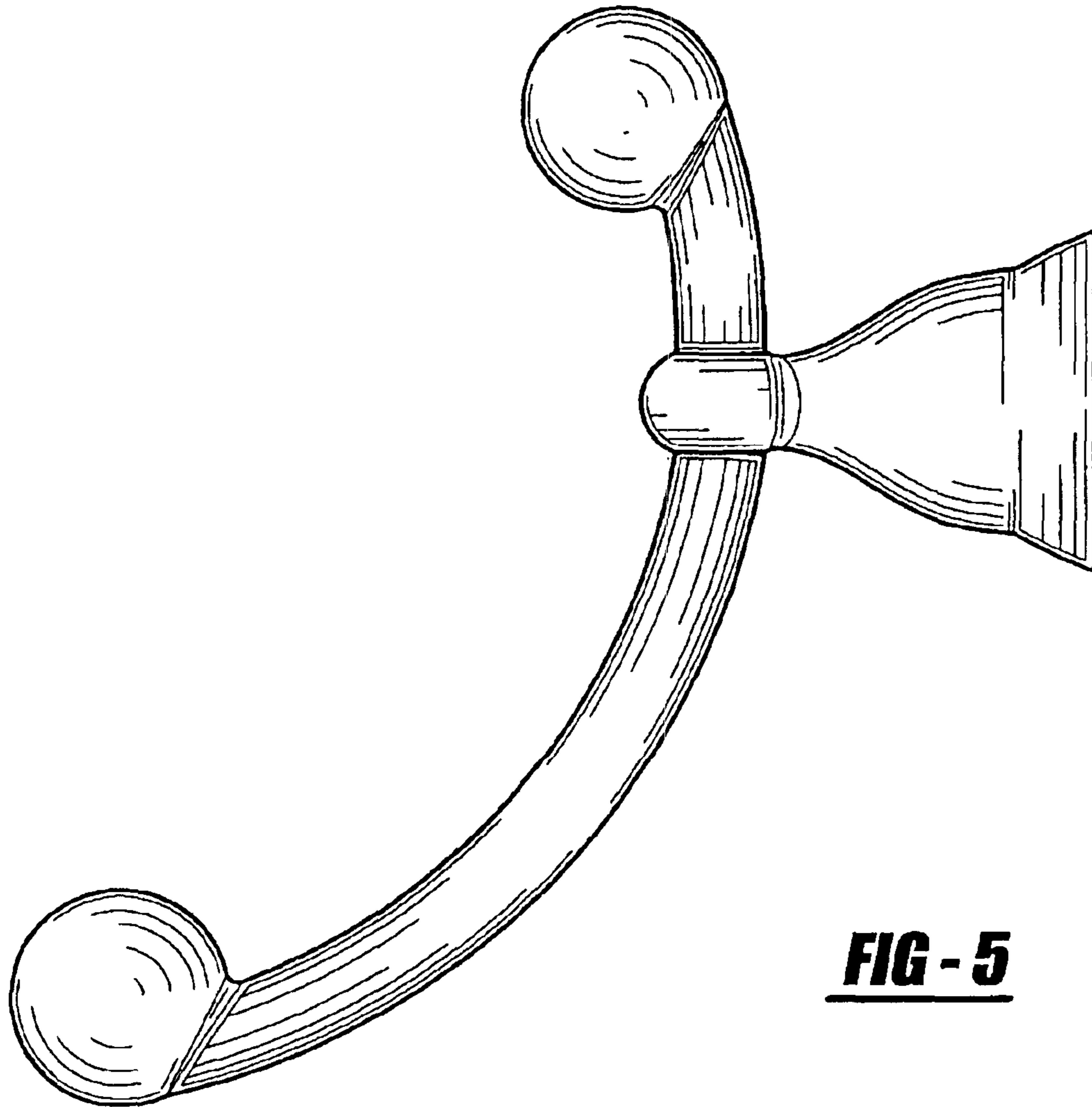
**FIG-2**



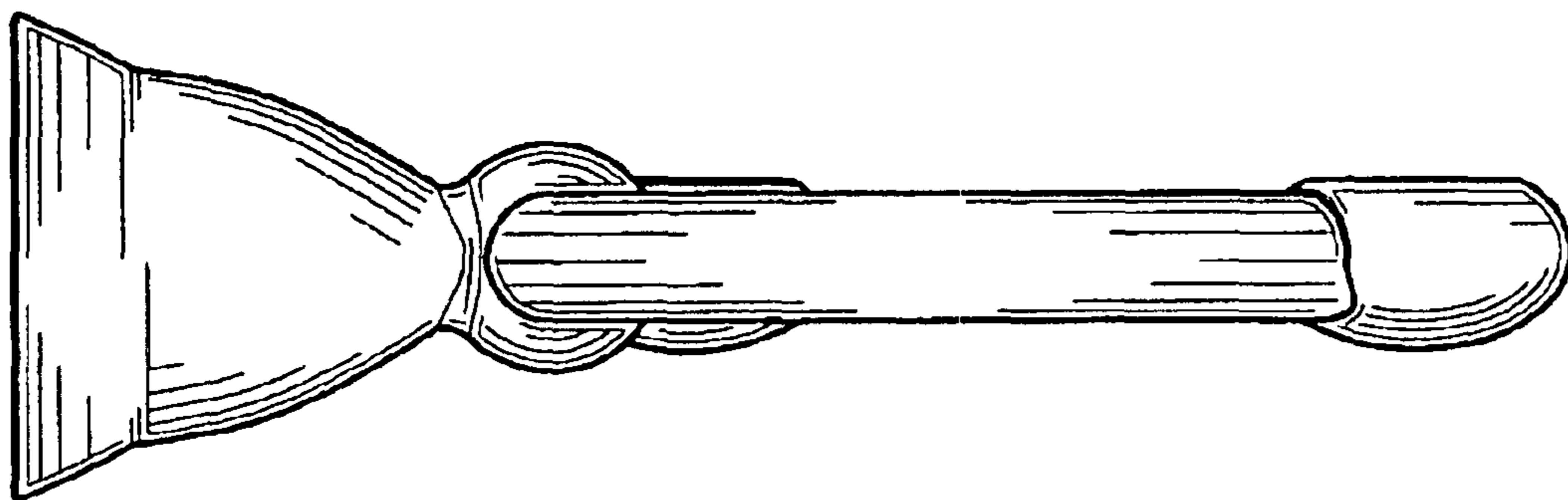
**FIG - 3**



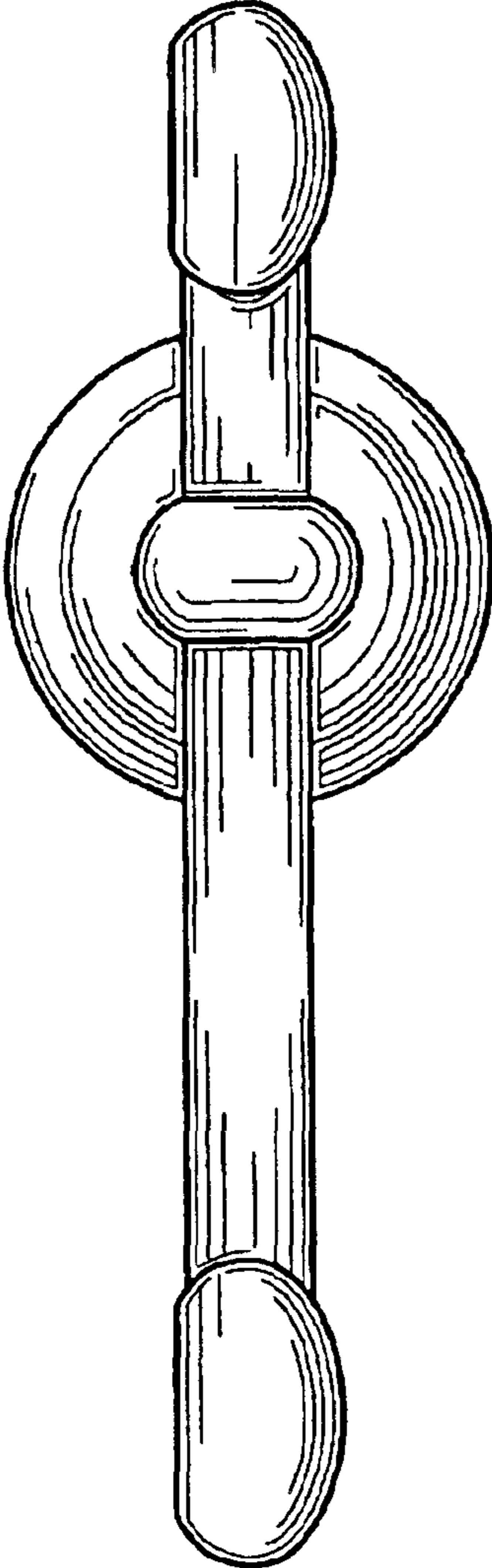
**FIG - 4**



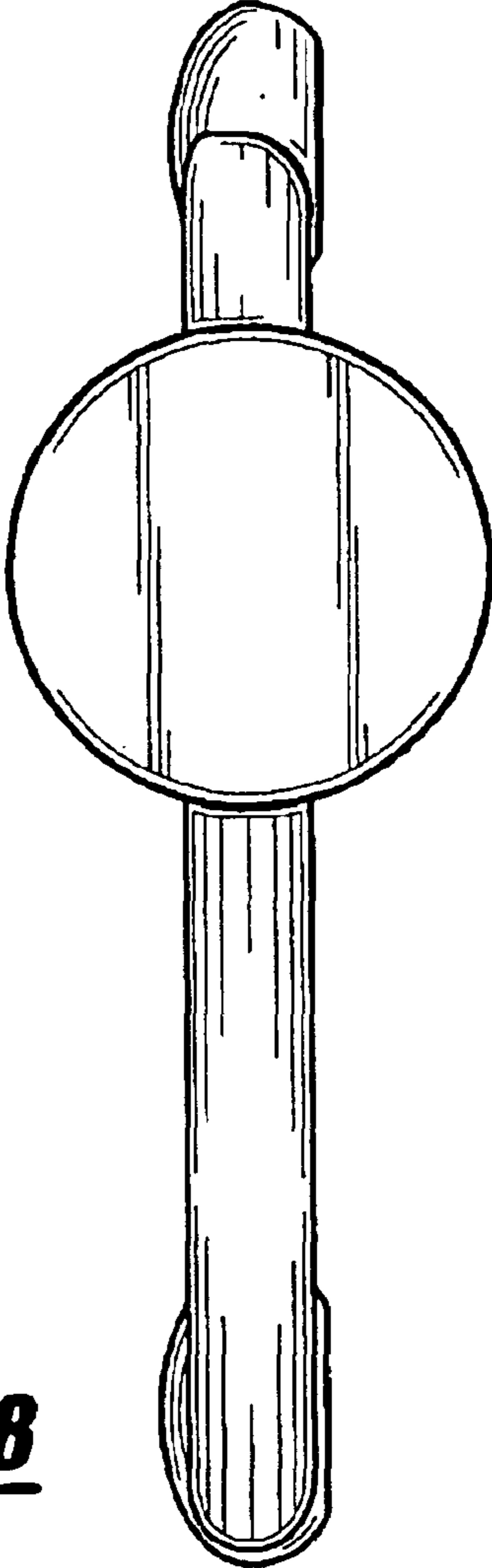
**FIG - 5**



**FIG - 6**



**FIG - 7**



**FIG - 8**