

US00D498334S

(12) **United States Design Patent**
Durocher et al.

(10) **Patent No.: US D498,334 S**
(45) **Date of Patent: ** Nov. 9, 2004**

(54) **HOCKEY HELMET**

6,298,497 B1 * 10/2001 Chartrand 2/414
2003/0135914 A1 * 7/2003 Racine et al. 2/413

(75) Inventors: **Jacques Durocher, St-Jérôme (CA);
Jean-François Béland, Montreal (CA)**

OTHER PUBLICATIONS

(73) Assignee: **Bauer Nike Hockey Inc., St-Jérôme
(CA)**

2003 Player Catalog USA; pp. 20–21.
Nike 2003 Hockey Catalog–LISTEN TO ME 2003, pp. 1, 2,
3, 8 and 9.

(**) Term: **14 Years**

* cited by examiner

(21) Appl. No.: **29/181,125**

Primary Examiner—Ruth McInroy

(22) Filed: **May 6, 2003**

(57) **CLAIM**

(51) **LOC (7) Cl. 09-03**

We claim the ornamental design for a hockey helmet, as
shown and described.

(52) **U.S. Cl. D29/106**

(58) **Field of Search** 2/6.1–6.7, 5, 412–414,
2/421, 423–425, 427, 171.3, 431, 9, 173;
D29/102–110, 112, 122; 128/201.23, 201.24

DESCRIPTION

(56) **References Cited**

FIG. 1 is a perspective view of a hockey helmet showing our
new design;
FIG. 2 is a left side elevational view thereof;
FIG. 3 is a front elevational view thereof;
FIG. 4 is a rear elevational view thereof;
FIG. 5 is a right side elevational view thereof; and,
FIG. 6 is a top plan view thereof.
The broken lines shown in FIGS. 1–6 are for illustrative
purposes only and form no part of the claimed design.

U.S. PATENT DOCUMENTS

D364,264 S	*	11/1995	Sheer	D2/869
D371,638 S	*	7/1996	Hoshizaki et al.	D29/106
D401,018 S	*	11/1998	Chartrand	D29/106
D412,766 S	*	8/1999	Tang	D29/106
D428,535 S	*	7/2000	Ball et al.	D29/106
D433,541 S	*	11/2000	Ball et al.	D29/106

1 Claim, 3 Drawing Sheets

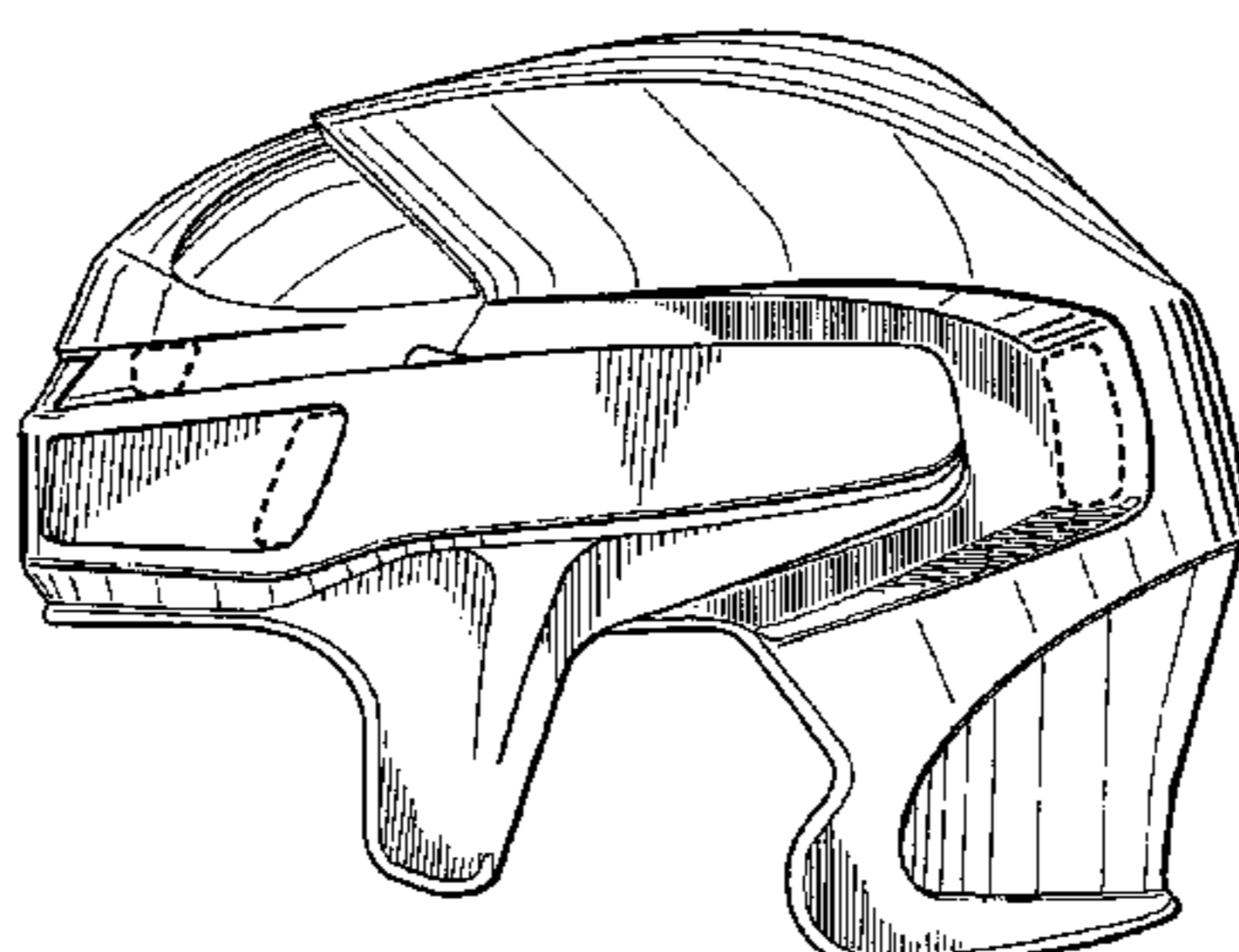
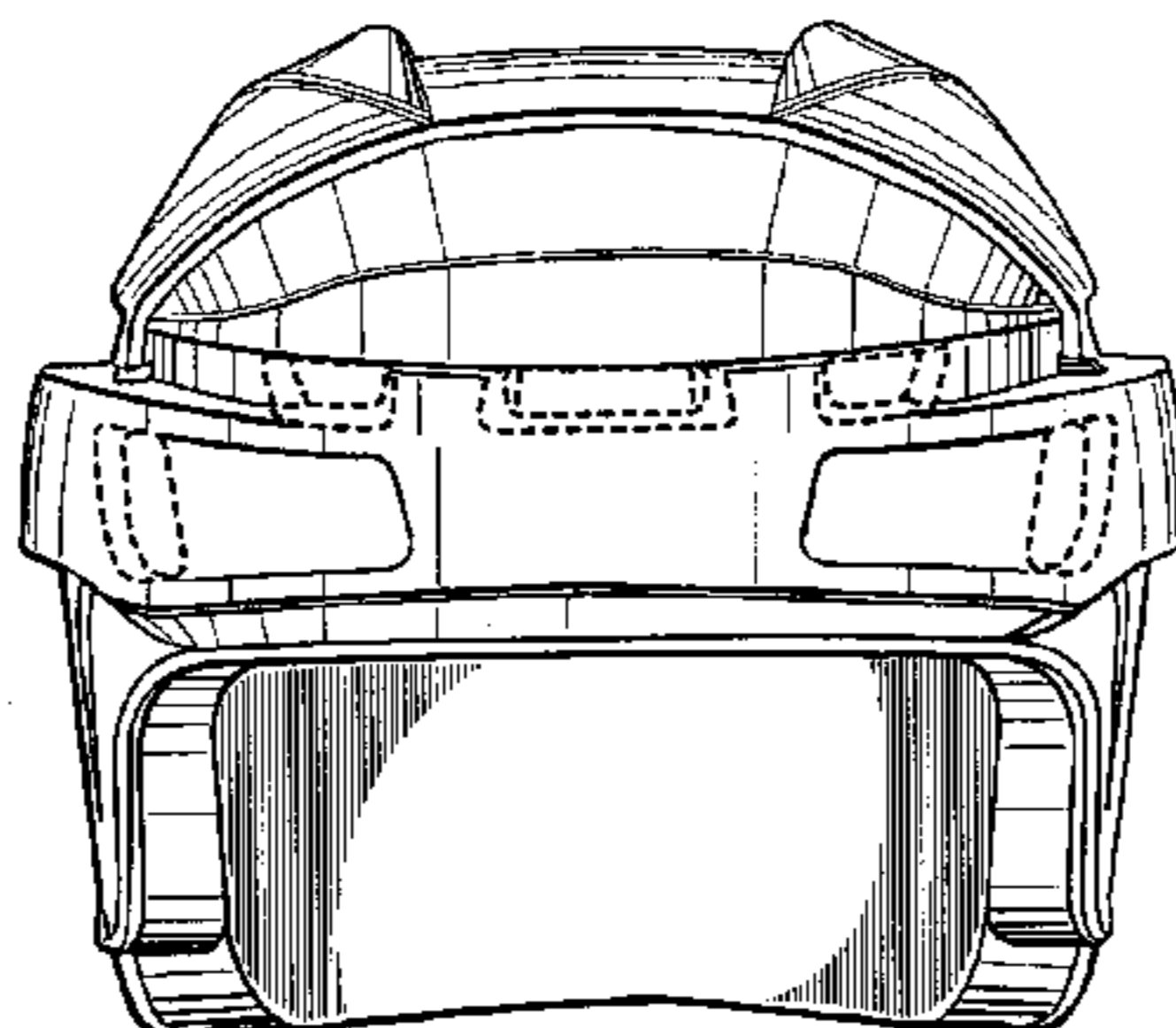
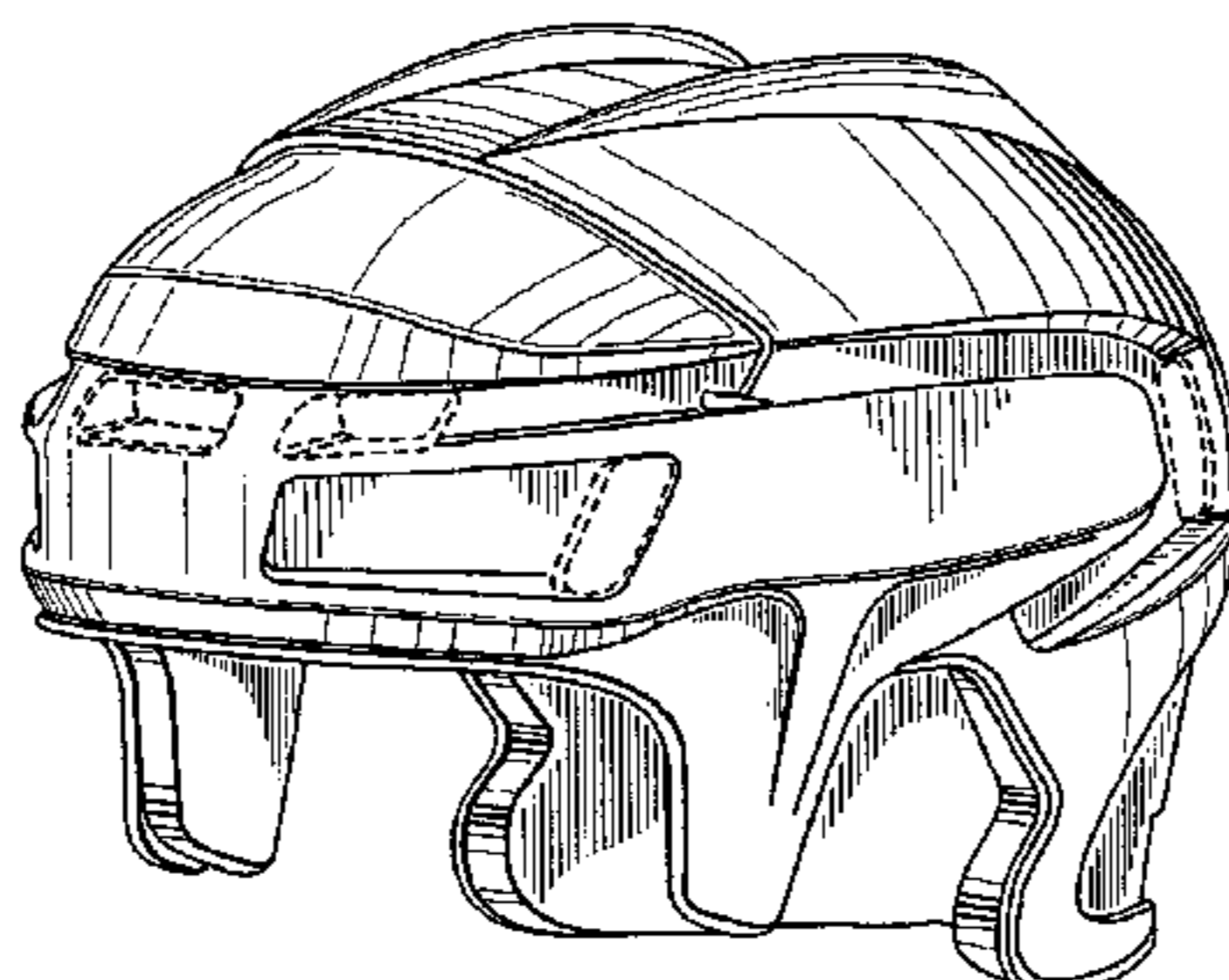

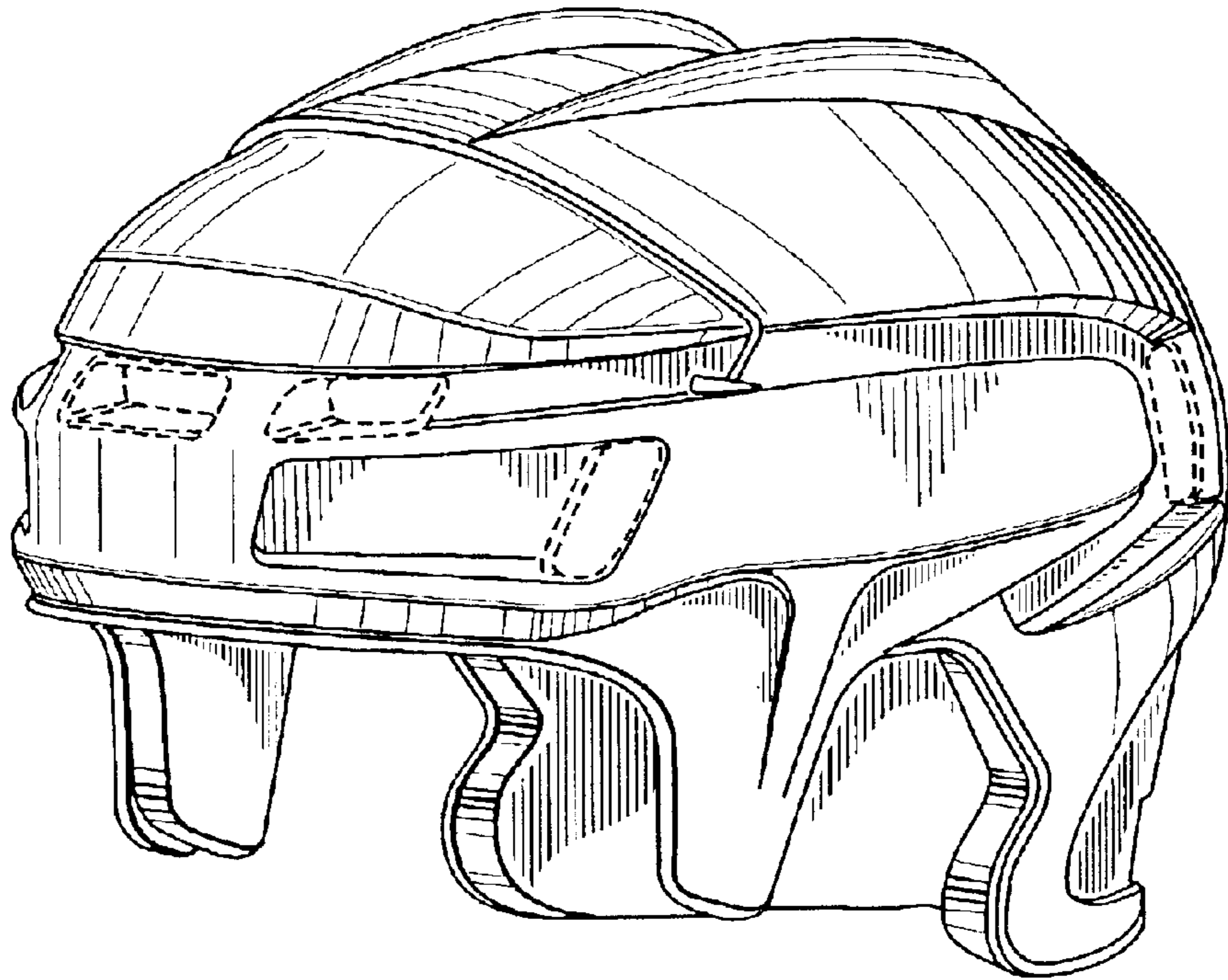

FIG. 1

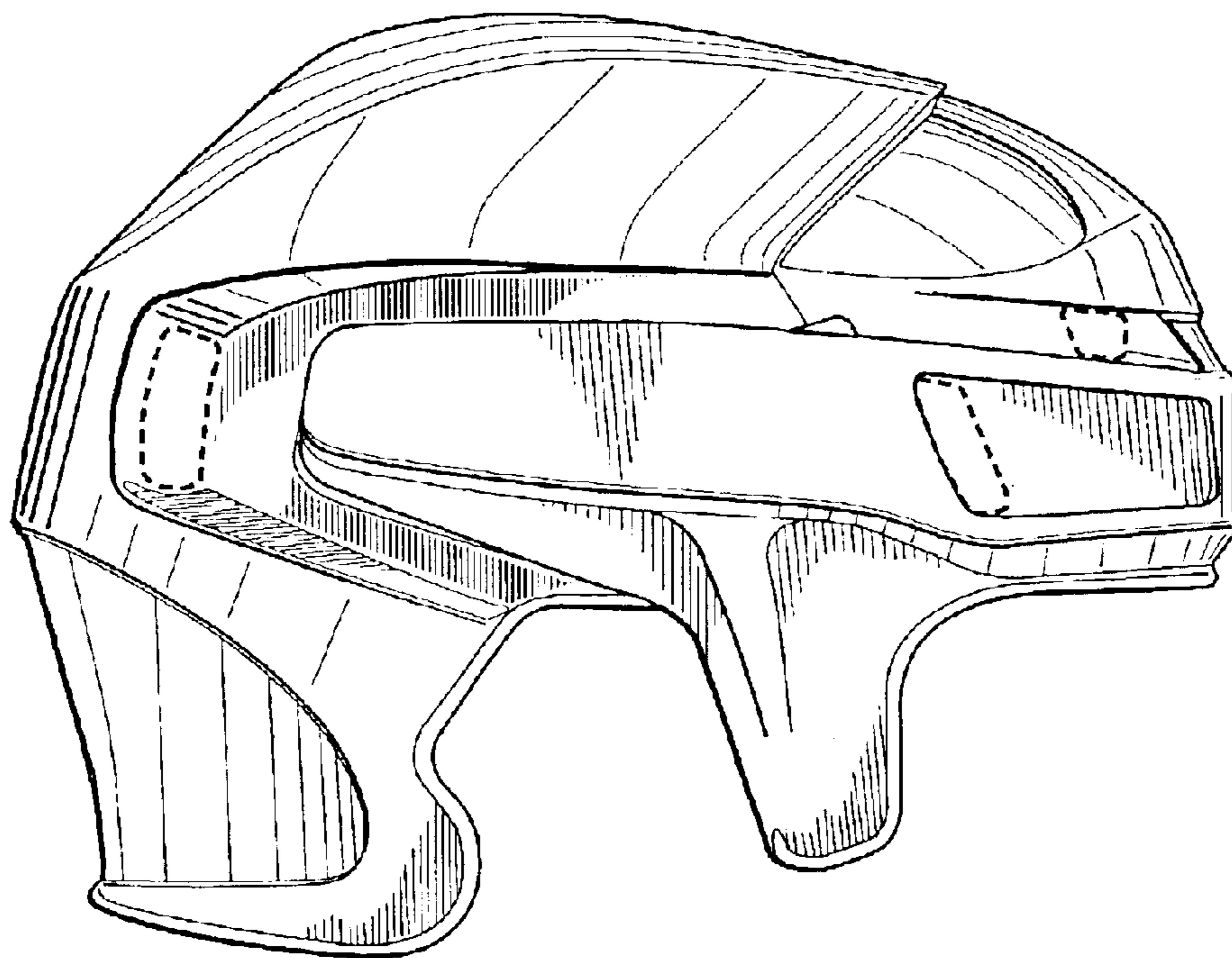

FIG. 2

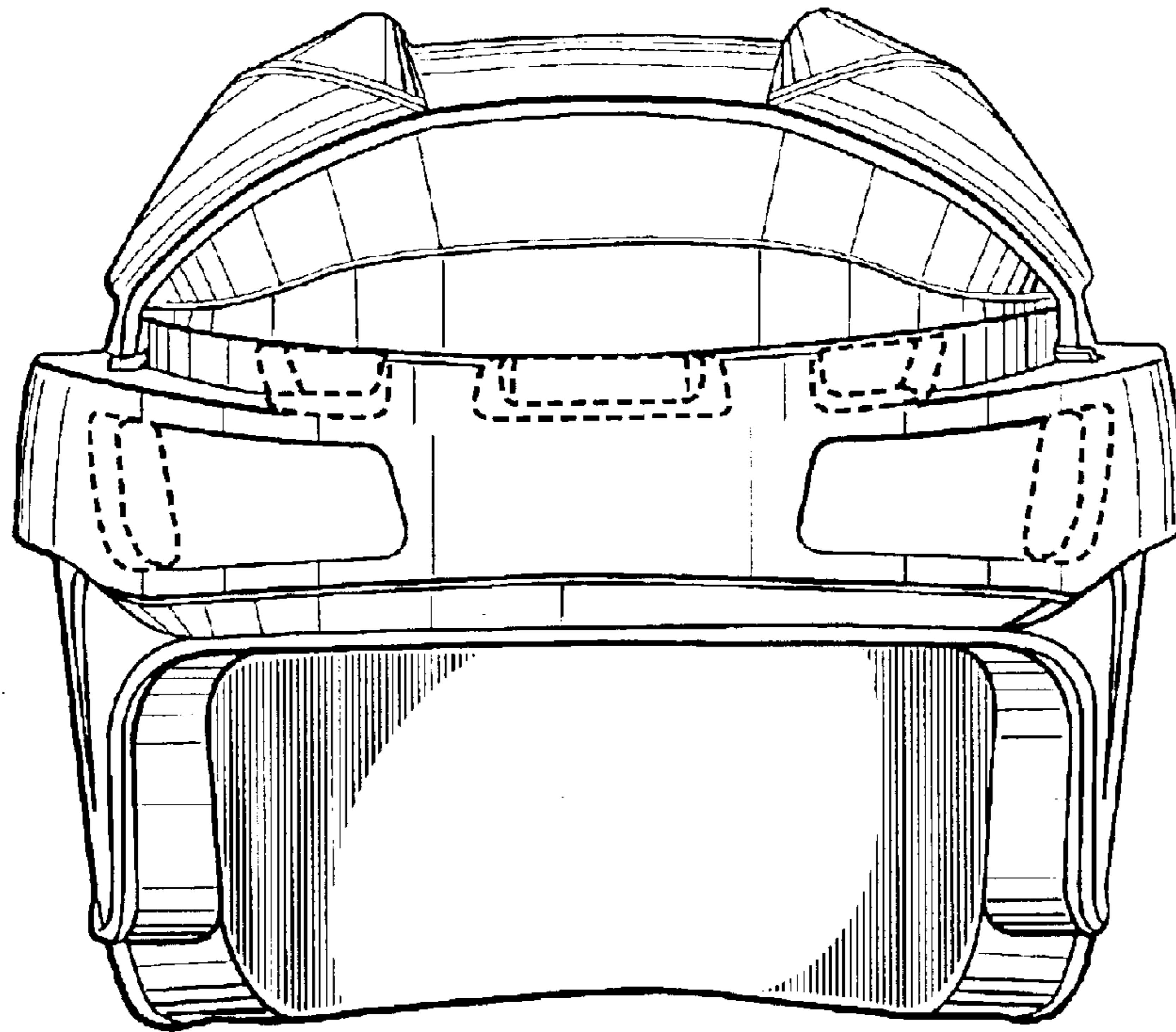

FIG. 3

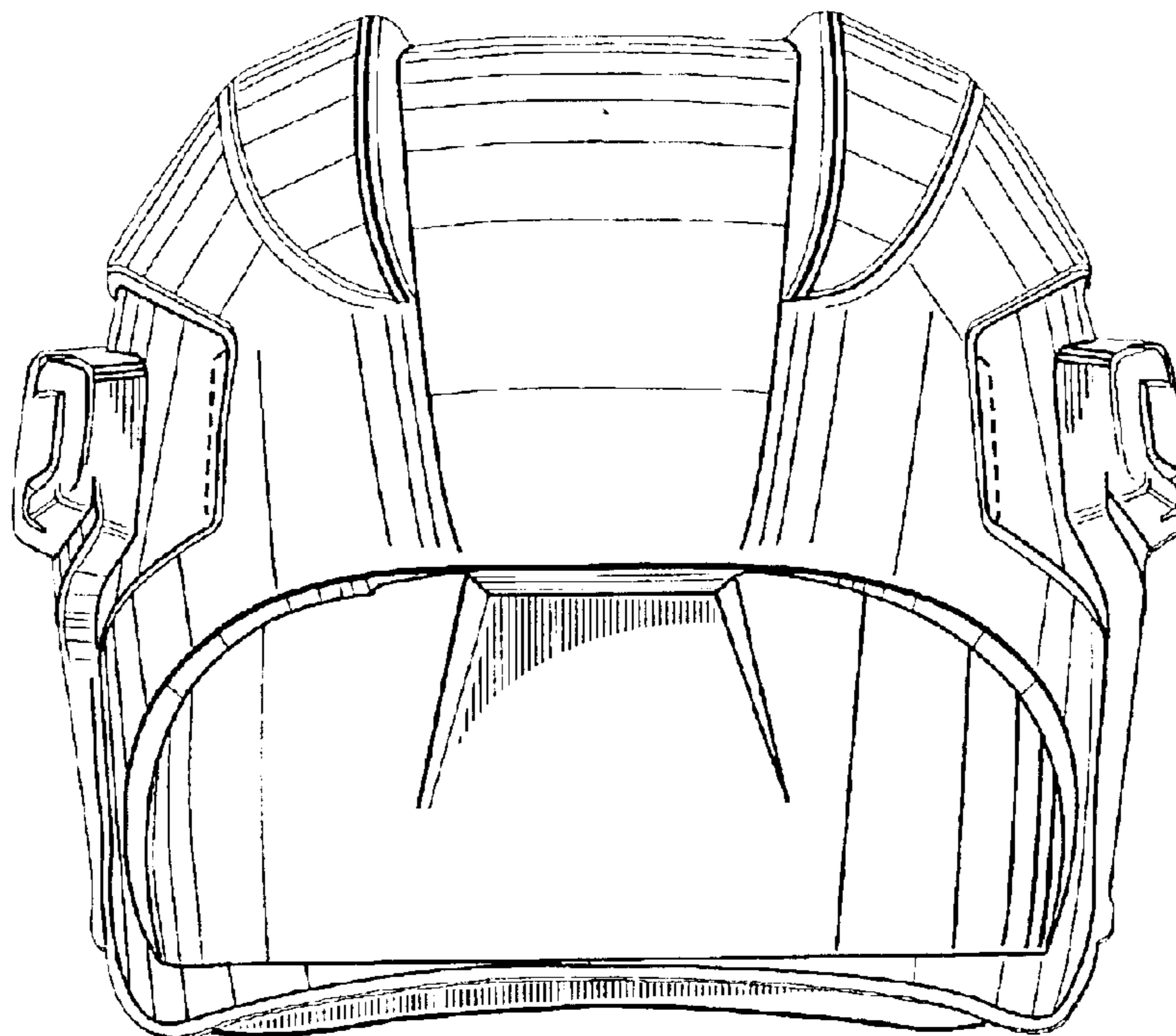

FIG. 4

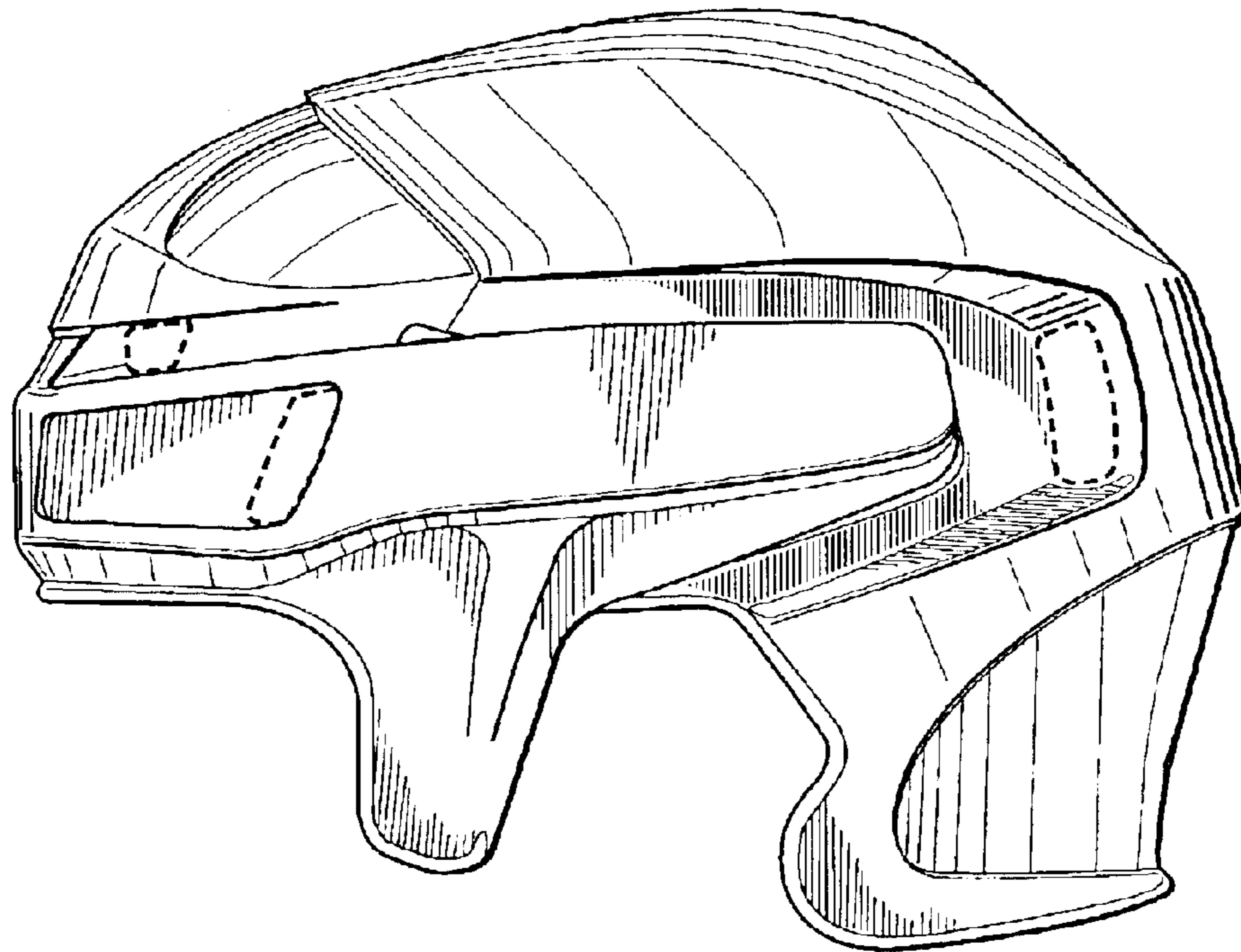

FIG. 5

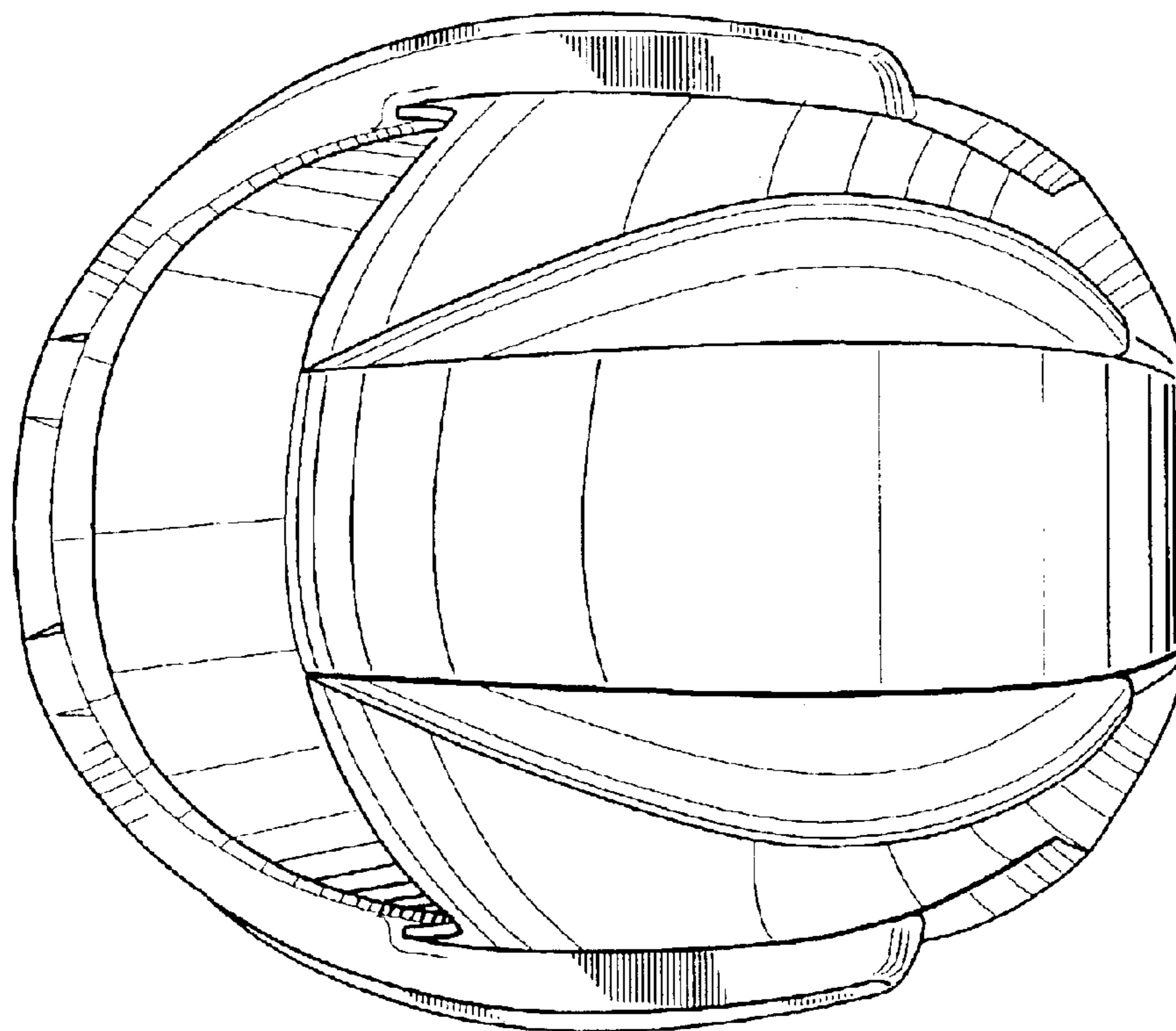

FIG. 6