

US00D498296S

(12) **United States Design Patent**
Shimizu

(10) **Patent No.:** **US D498,296 S**

(45) **Date of Patent:** **** Nov. 9, 2004**

(54) **AIR PURIFIER**

(75) Inventor: **Hisashi Shimizu**, Kusatsu (JP)

(73) Assignee: **Daikin Industries Ltd.**, Osaka (JP)

(**) Term: **14 Years**

(21) Appl. No.: **29/180,273**

(22) Filed: **Apr. 22, 2003**

(51) **LOC (7) Cl.** **23-04**

(52) **U.S. Cl.** **D23/364**

(58) **Field of Search** D23/355, 364,
D23/365; 55/467, 471, 472

(56) **References Cited**

U.S. PATENT DOCUMENTS

- D379,220 S * 5/1997 Ellwood D23/364
- D451,181 S * 11/2001 Miwa D23/364
- 6,425,932 B1 * 7/2002 Huehn et al. 55/471
- D472,626 S * 4/2003 Nakamura D23/364
- D489,801 S * 5/2004 Shimizu D23/364

* cited by examiner

Primary Examiner—Robin V. Taylor

(74) *Attorney, Agent, or Firm*—Manabu Kanesaka

(57) **CLAIM**

The ornamental design for an air purifier, as shown and described.

DESCRIPTION

FIG. 1 is a perspective view of an air purifier showing my new design;

FIG. 2 is a front view thereof;

FIG. 3 is a rear view thereof;

FIG. 4 is a plan view thereof;

FIG. 5 is a bottom view thereof;

FIG. 6 is a right side view thereof, a left side view being symmetrical to the right view;

FIG. 7 is a sectional view taken along line 7—7 in FIG. 2; and,

FIG. 8 is a sectional view taken along line 8—8 in FIG. 2.

The broken line showing of the environment is for illustrative purposes only and forms no part of the claimed design.

1 Claim, 4 Drawing Sheets

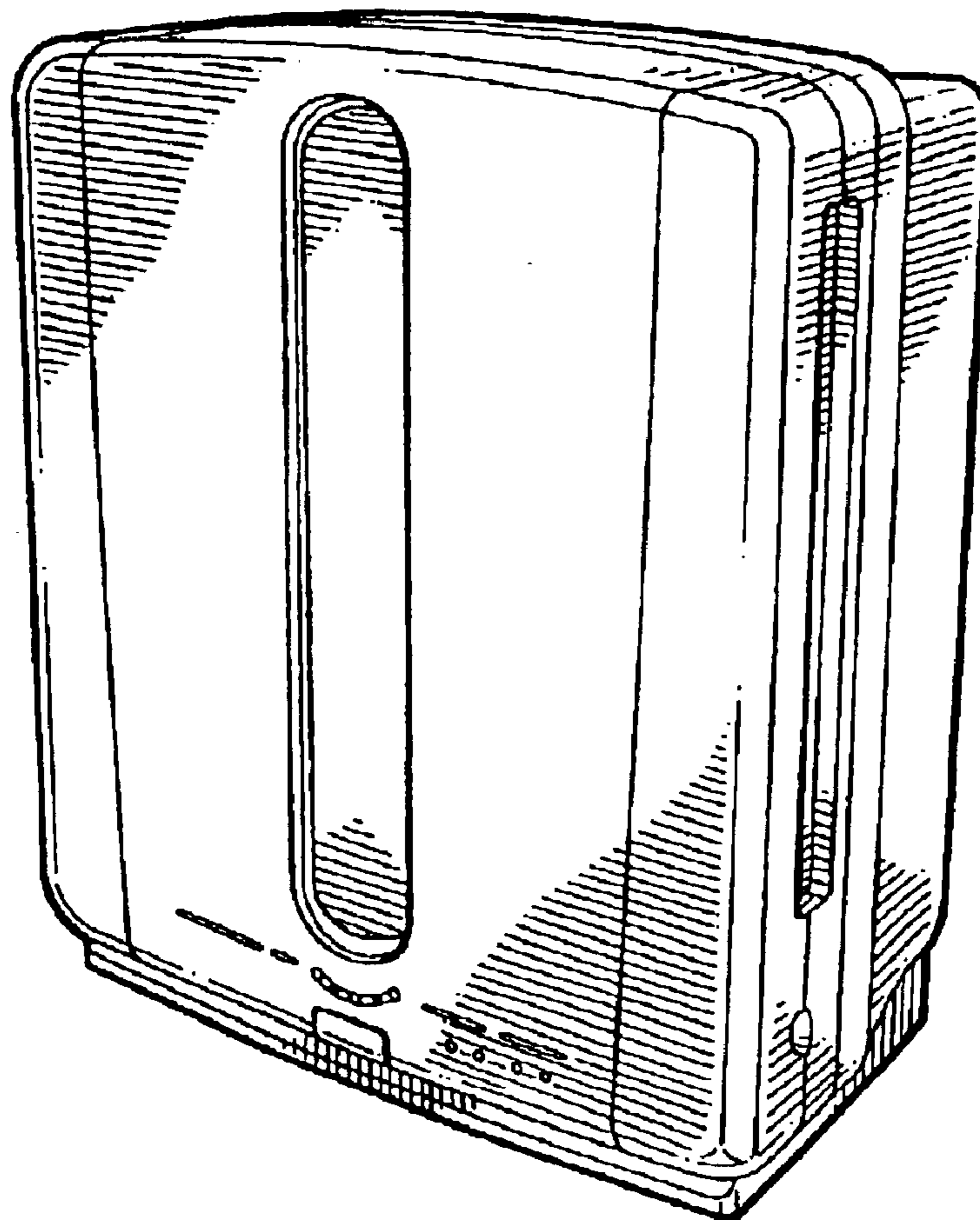

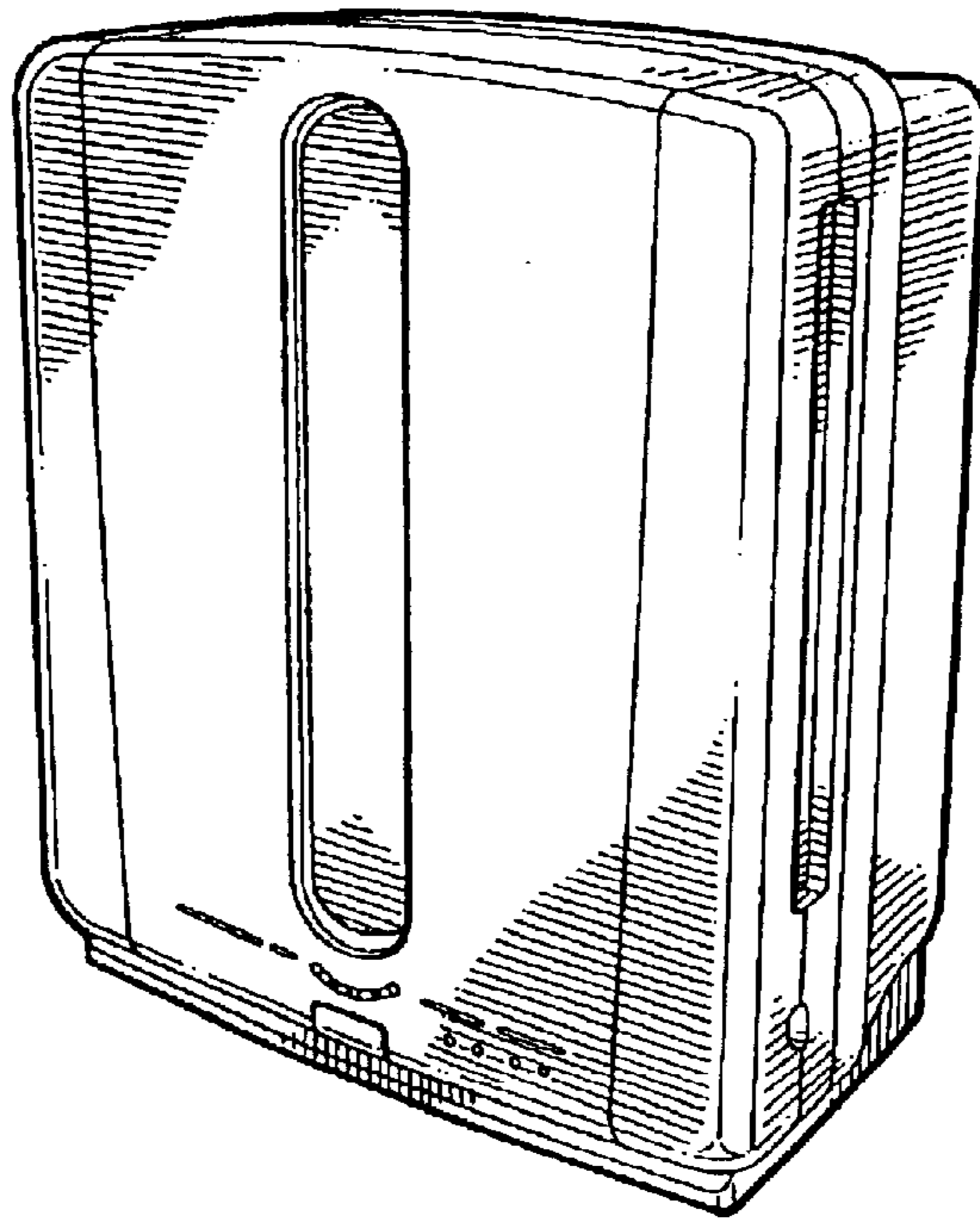

FIG. 1

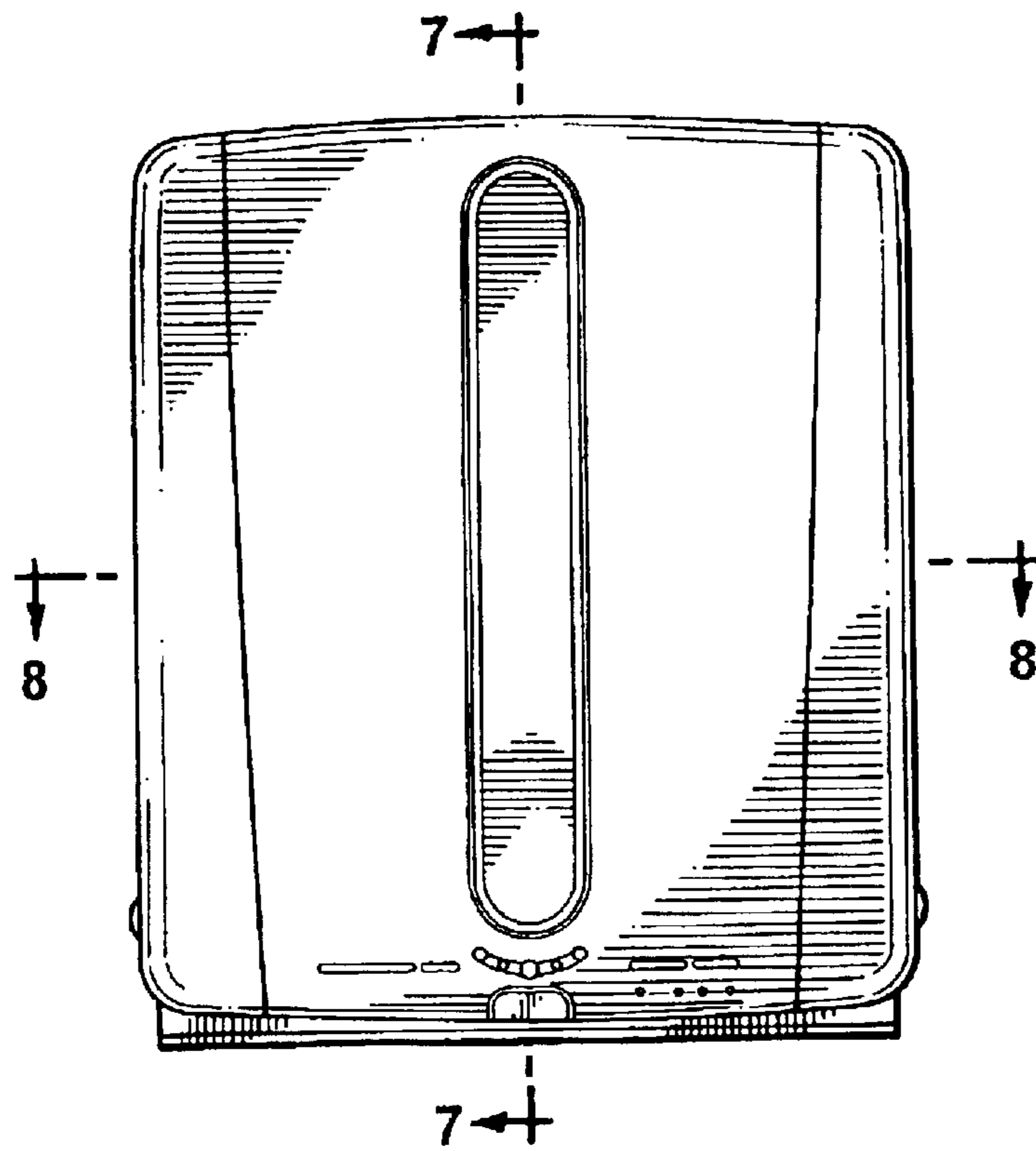

FIG. 2

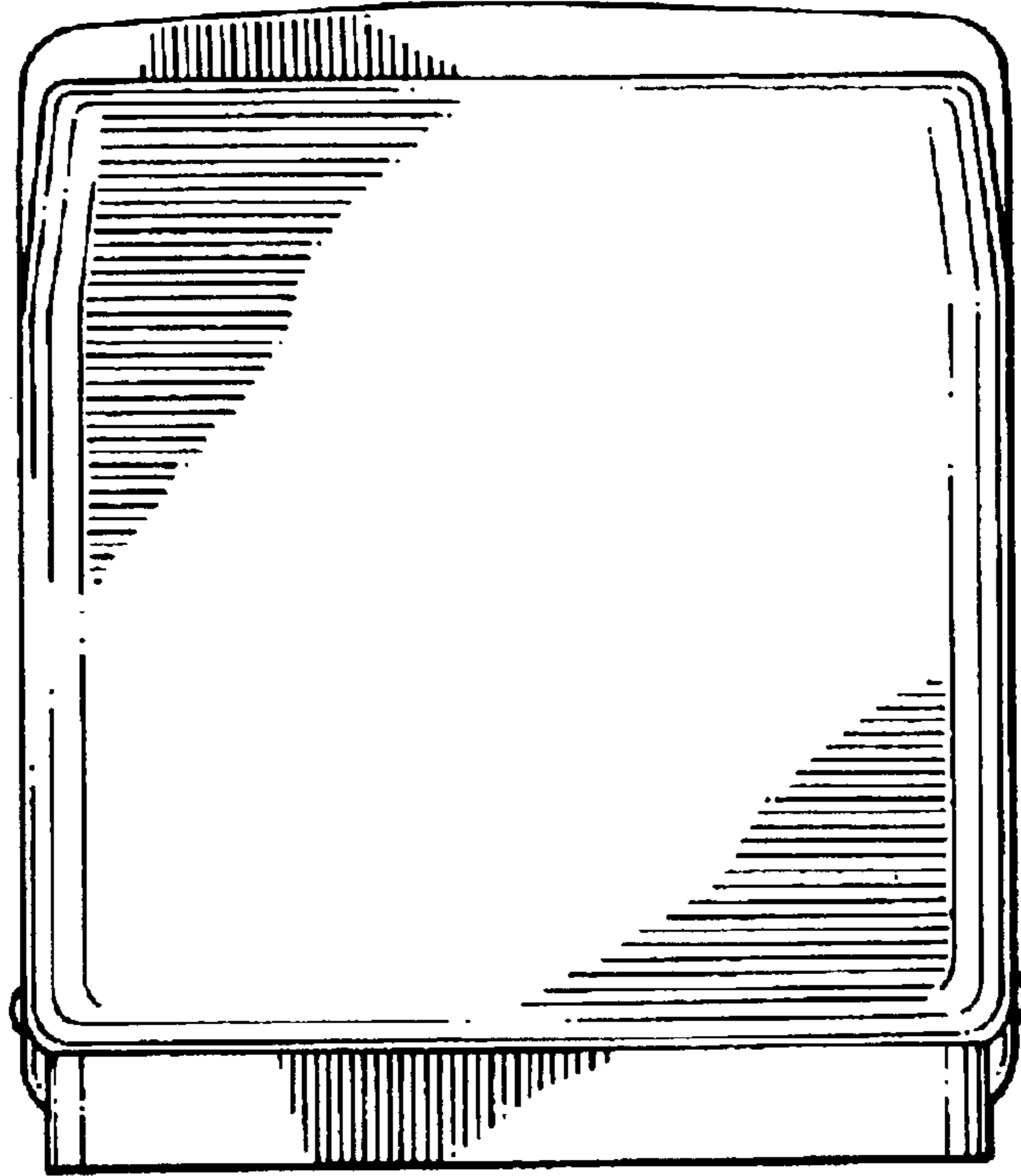

FIG. 3



FIG. 4

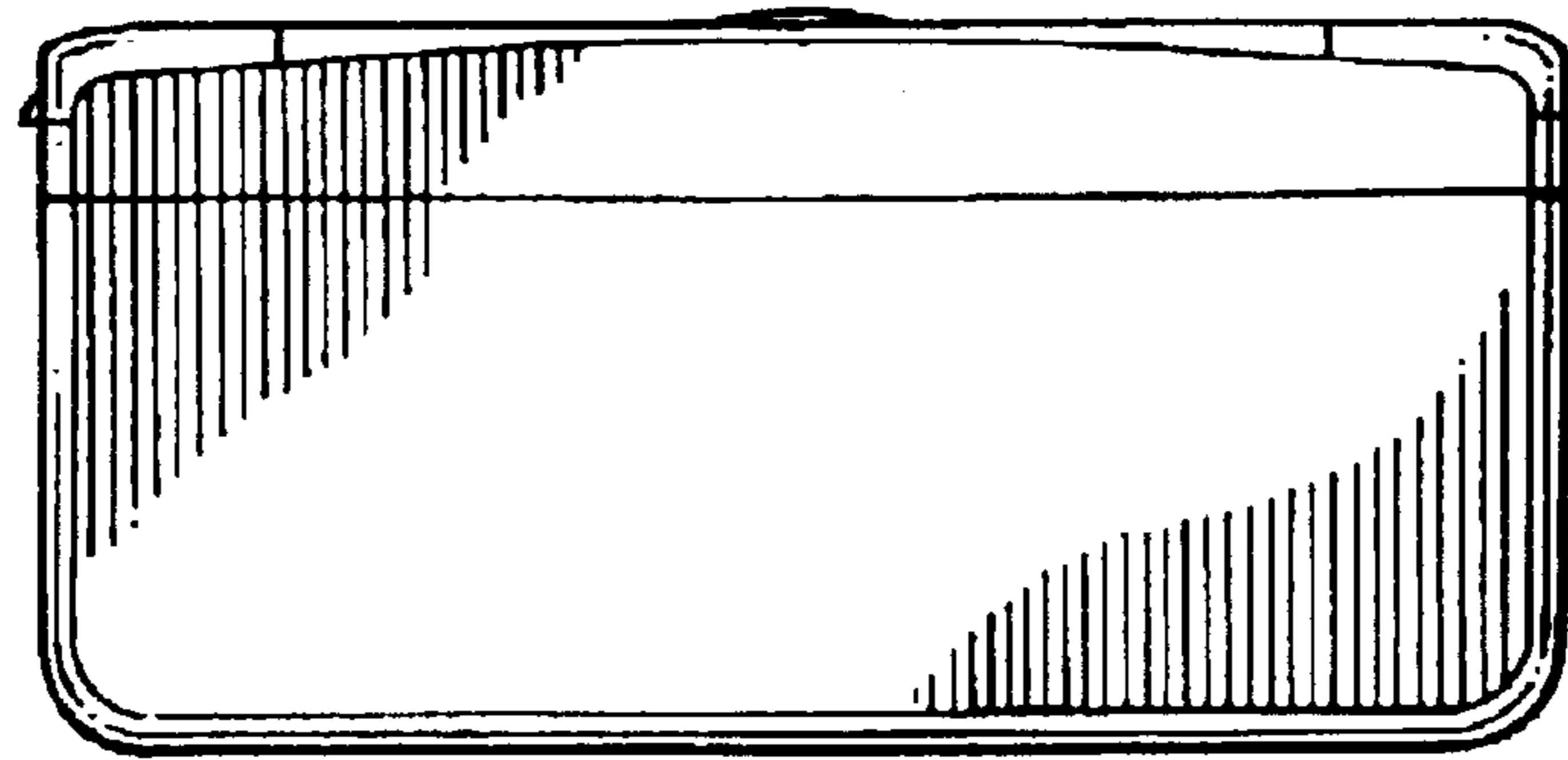

FIG. 5

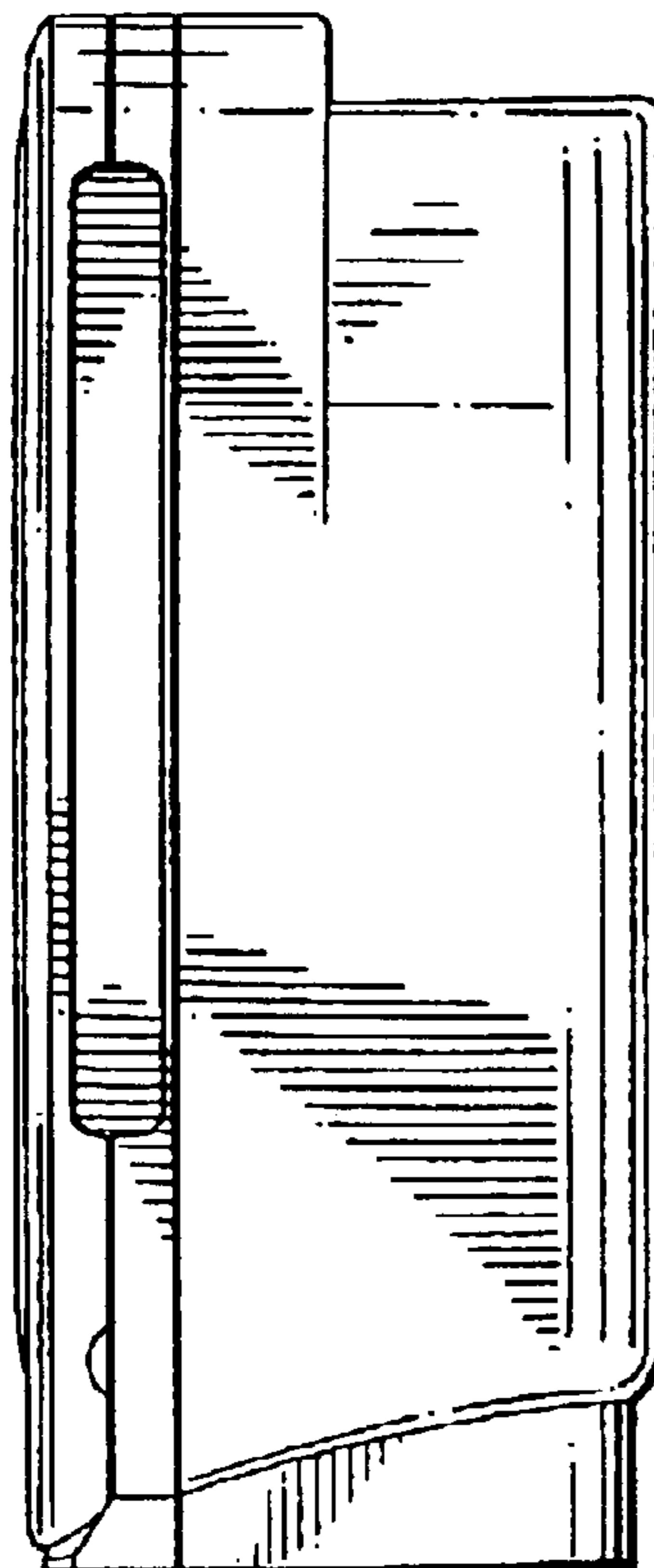

FIG. 6

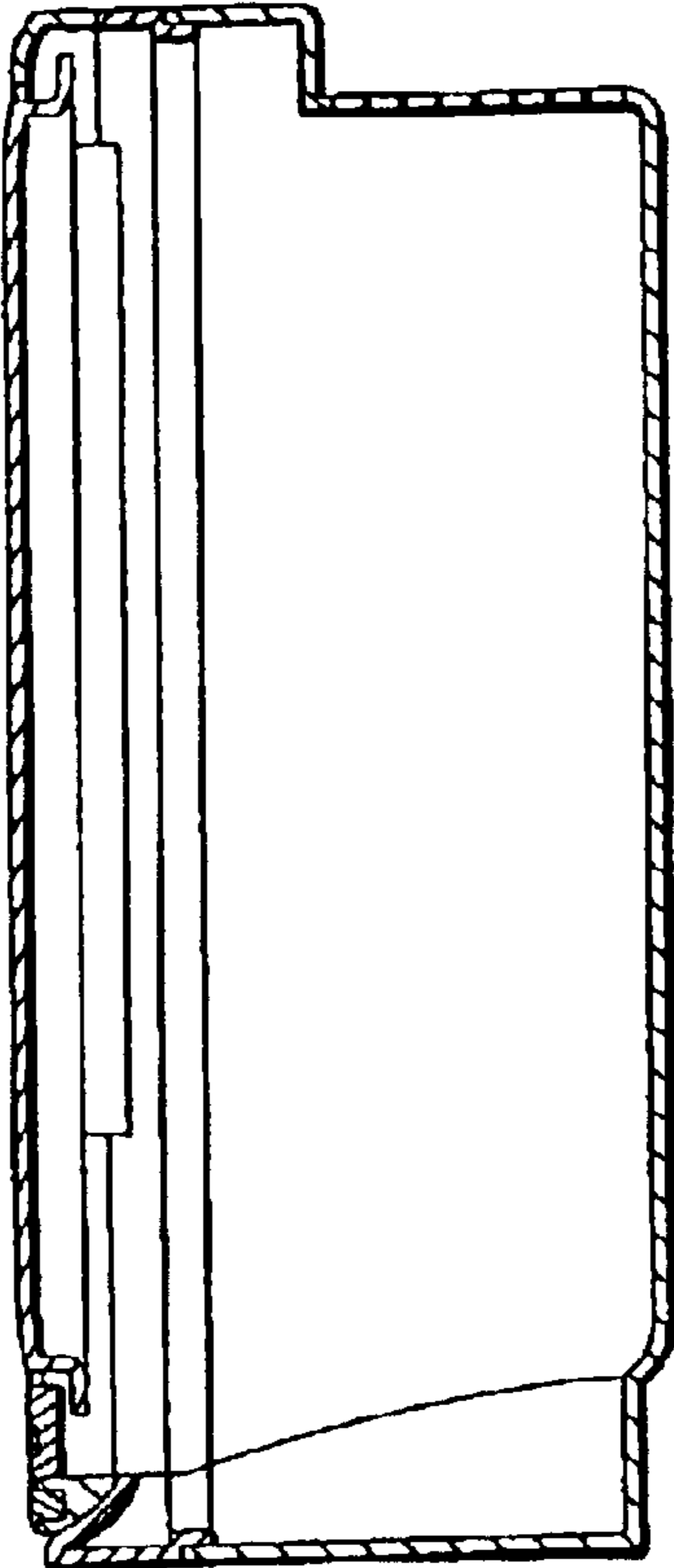

FIG. 7

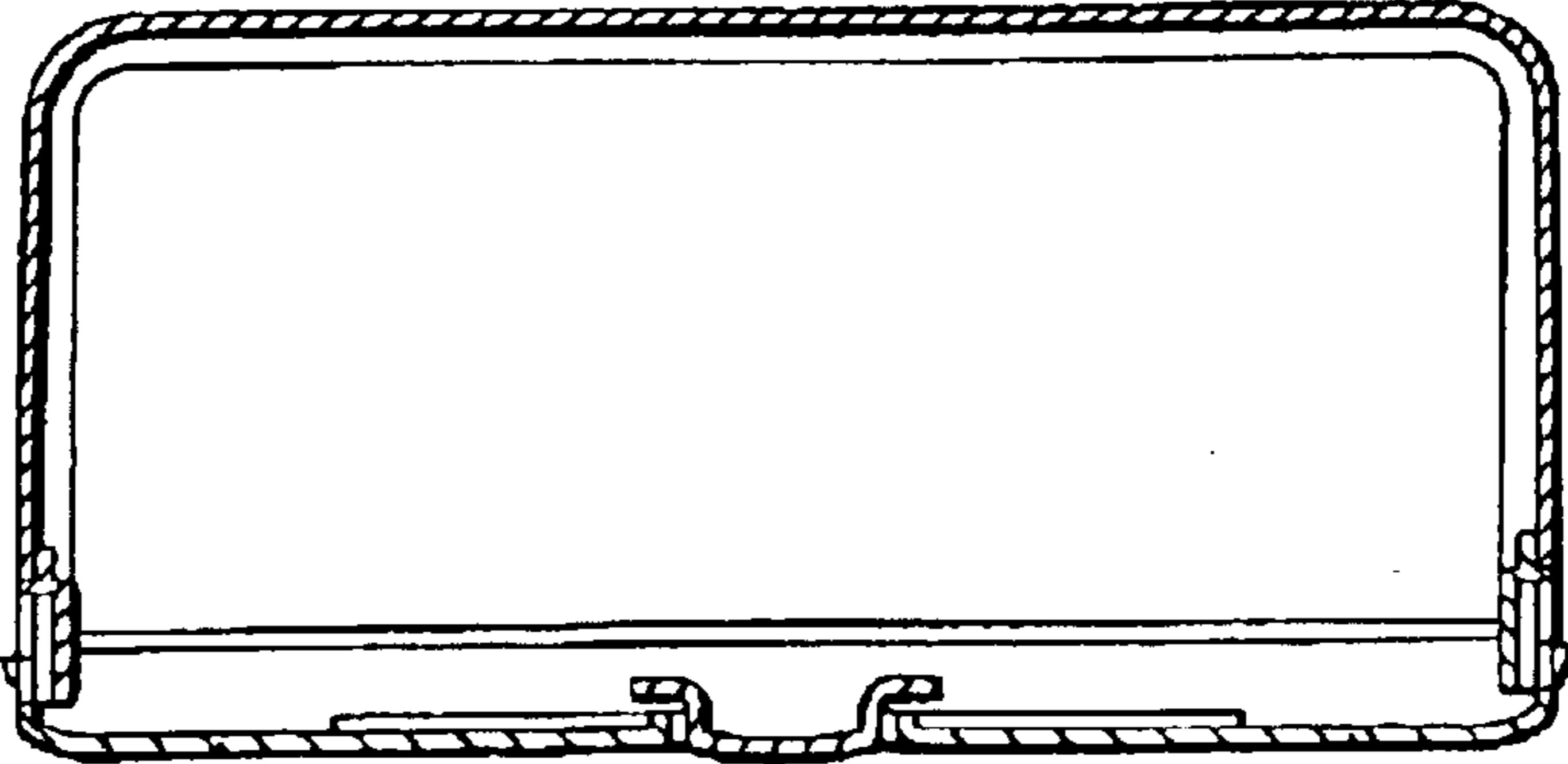

FIG. 8