

US00D498238S

(12) **United States Design Patent**
Xiao et al.

(10) **Patent No.:** **US D498,238 S**

(45) **Date of Patent:** **** Nov. 9, 2004**

(54) **COMPUTER FRONT BEZEL**

D474,477 S * 5/2003 Chien et al. D14/444

(75) Inventors: **Xin-Jian Xiao**, Shenzhen (CN); **Chun Chi Liang**, Tu-Chen (TW); **Yun-Dong Xu**, Shenzhen (CN); **Tao Su**, Shenzhen (CN)

* cited by examiner

Primary Examiner—Freda S. Nunn

(74) *Attorney, Agent, or Firm*—Wei Te Chung

(73) Assignee: **Hon Hai Precision Ind. Co., Ltd.**,
Taipei Hsien (TW)

(57) **CLAIM**

The ornamental design for a computer front bezel, as shown and described.

(**) Term: **14 Years**

DESCRIPTION

(21) Appl. No.: **29/195,961**

FIG. 1 is a perspective view of a computer front bezel of our new design;

(22) Filed: **Dec. 19, 2003**

FIG. 2 is a front elevational view thereof;

(51) **LOC (7) Cl.** **14-02**

FIG. 3 is a rear elevational view thereof;

(52) **U.S. Cl.** **D14/444**

FIG. 4 is a left side elevational view thereof;

(58) **Field of Search** D14/441-446;

FIG. 5 is a right side elevational view thereof;

D13/162, 184, 199; 312/223.2, 223.3; 360/99.01-99.12;
361/690-696; 369/34.01, 36.01

FIG. 6 is a top plan view thereof;

FIG. 7 is a bottom plan view thereof; and,

FIG. 8 is a perspective view thereof being mounted to a computer case and having a plurality of bars attached thereto, wherein the computer case and the bars are shown in broken lines for illustrative purposes only and form no part of the claimed design.

(56) **References Cited**

U.S. PATENT DOCUMENTS

D468,744 S * 1/2003 Chien et al. D14/444

D474,475 S * 5/2003 Chien et al. D14/444

1 Claim, 6 Drawing Sheets

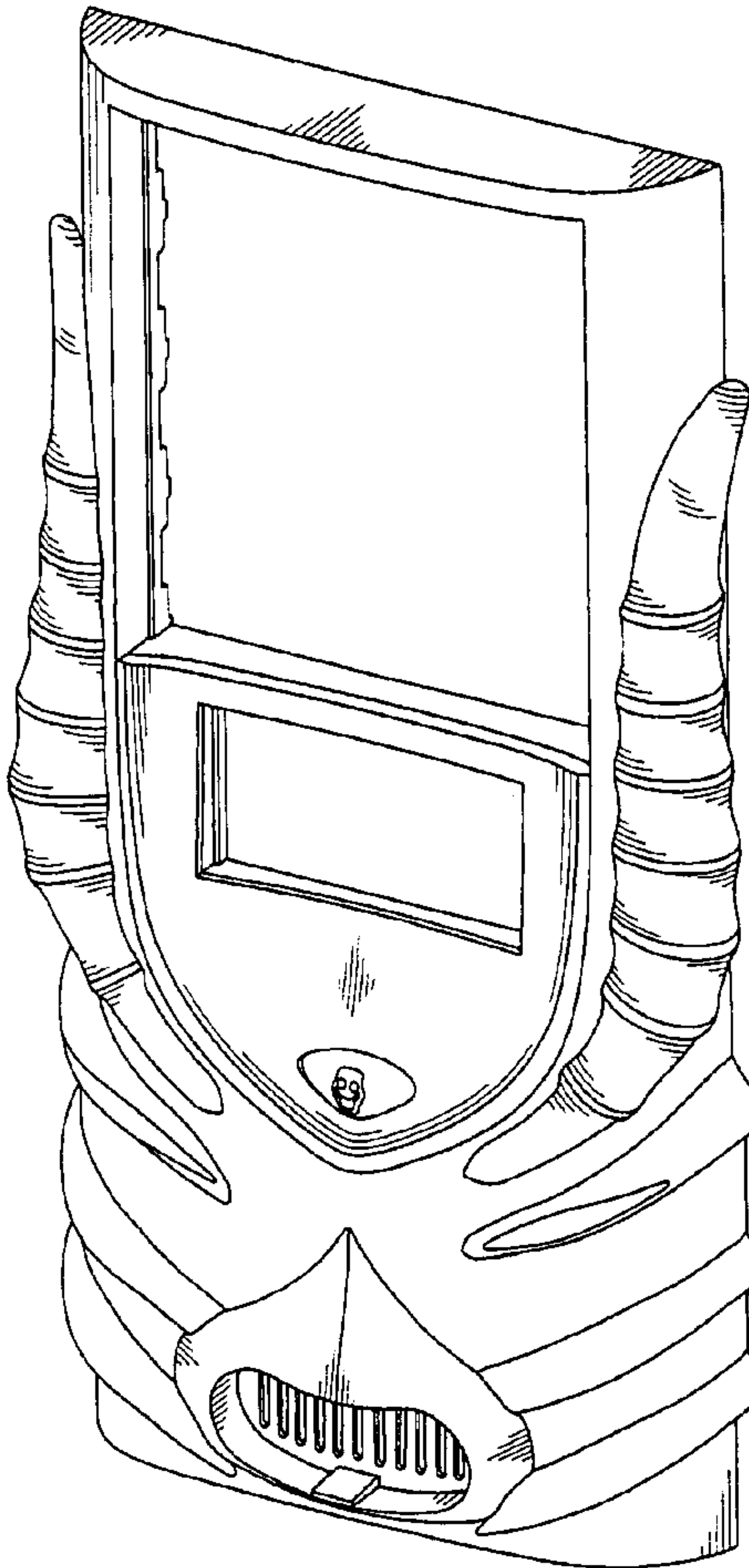

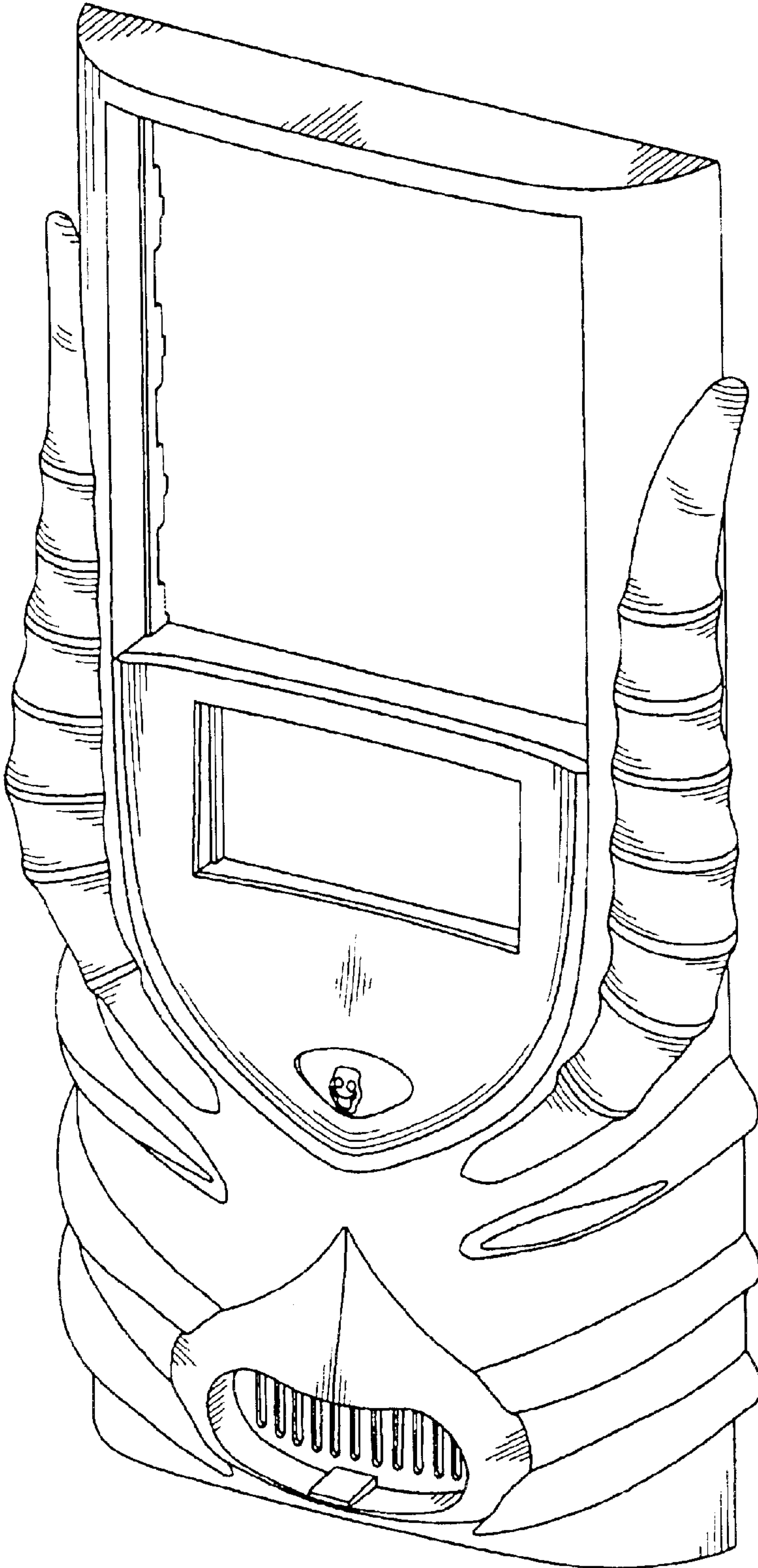

FIG. 1

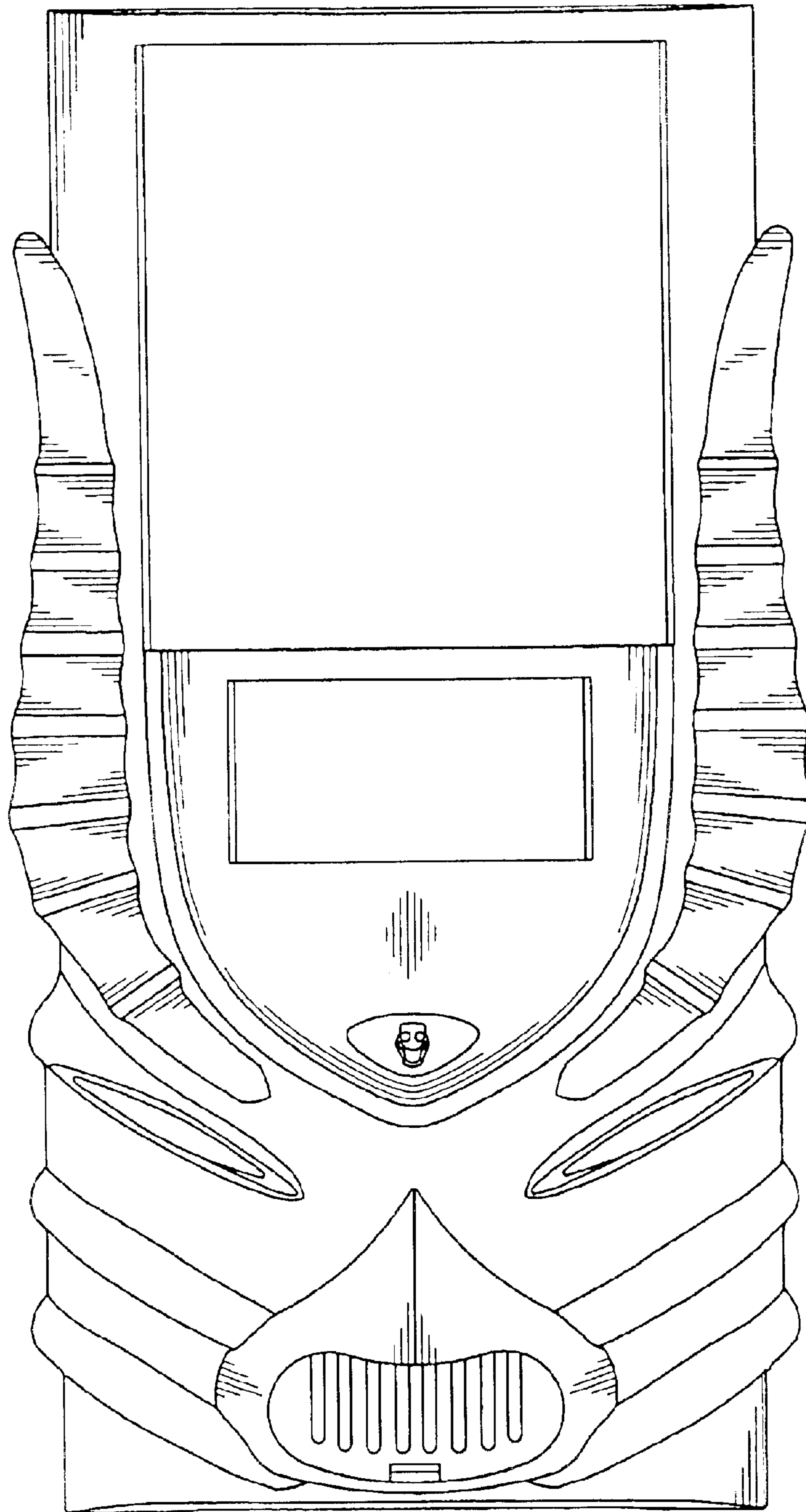

FIG. 2

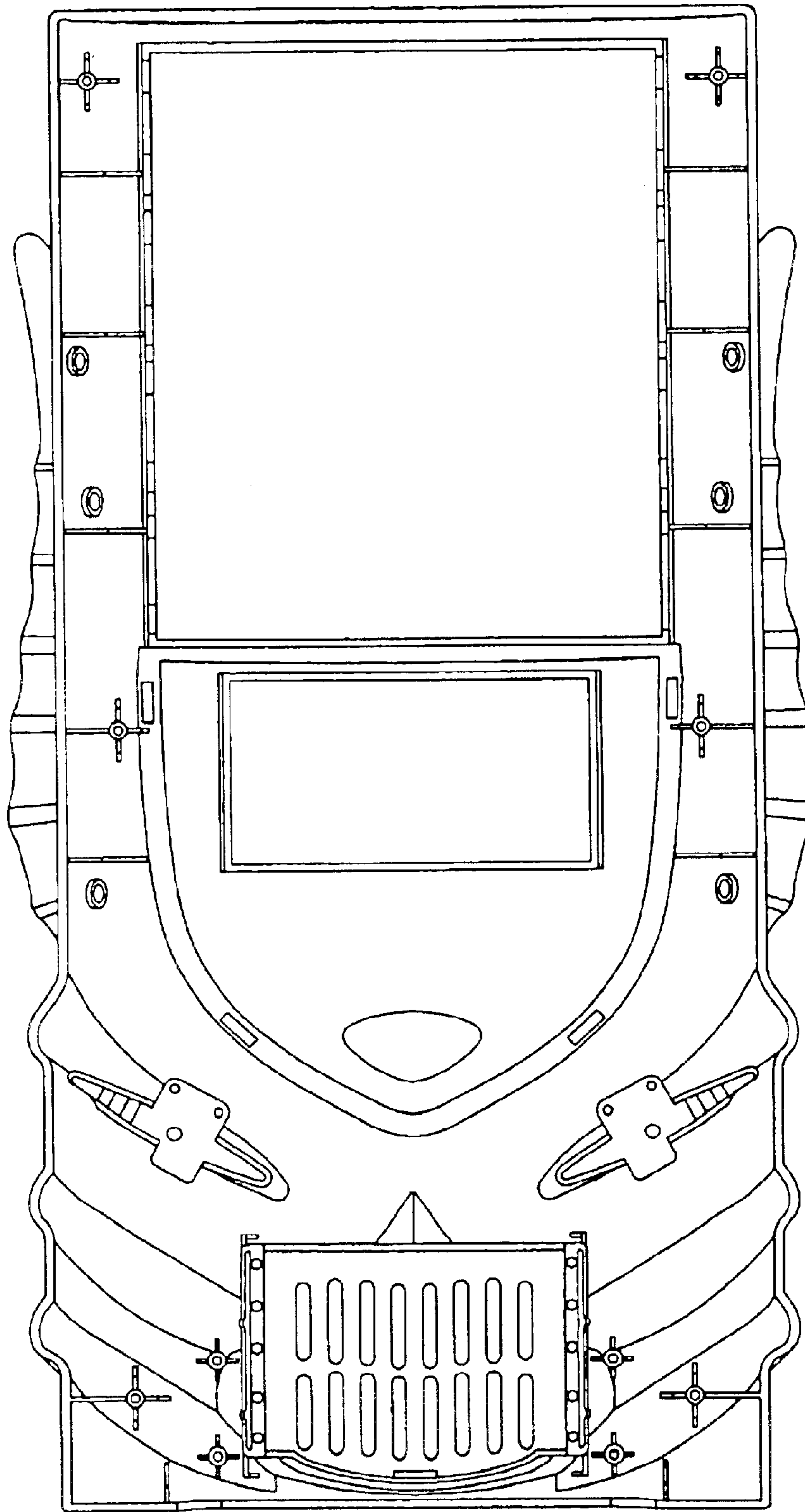

FIG. 3

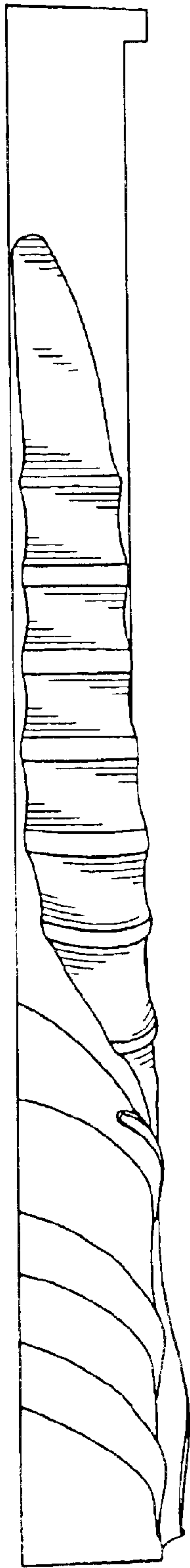

FIG. 4

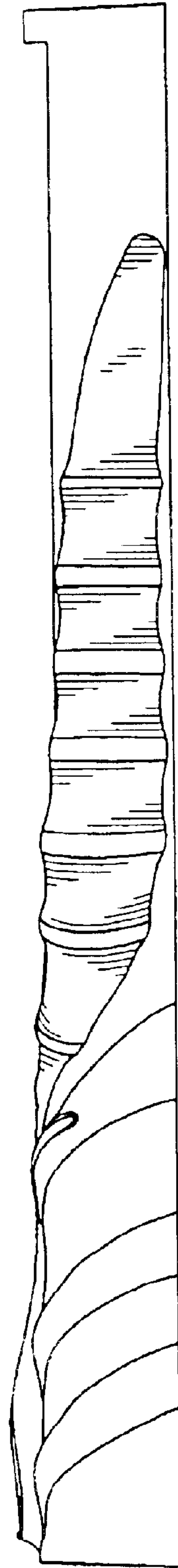

FIG. 5

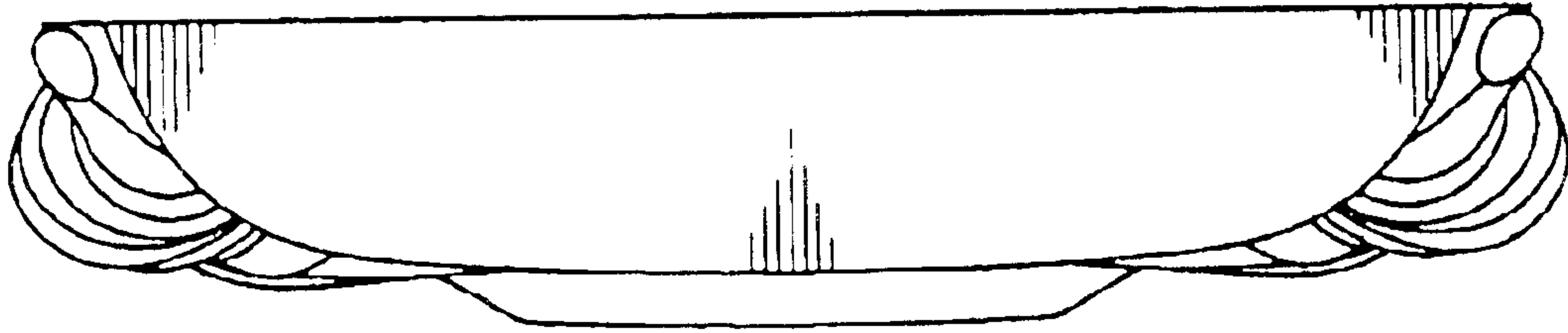

FIG. 6

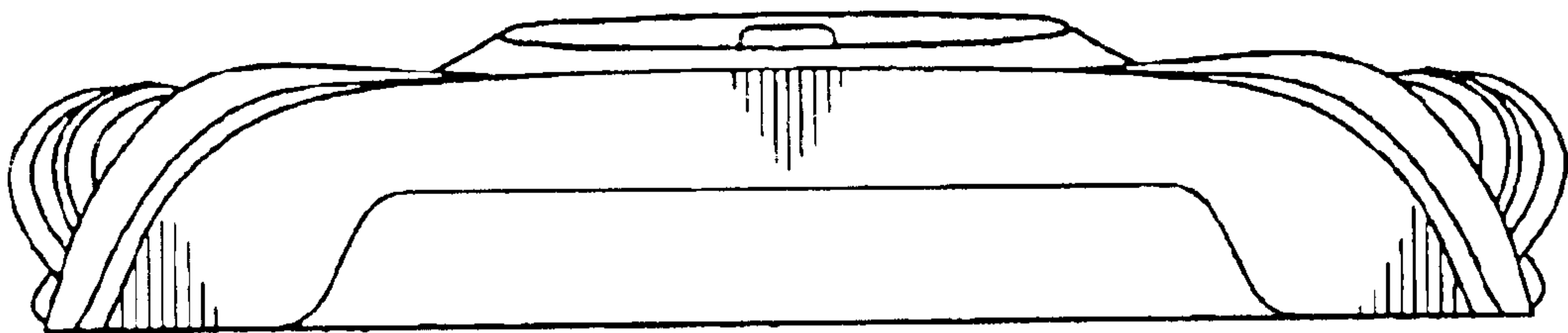

FIG. 7

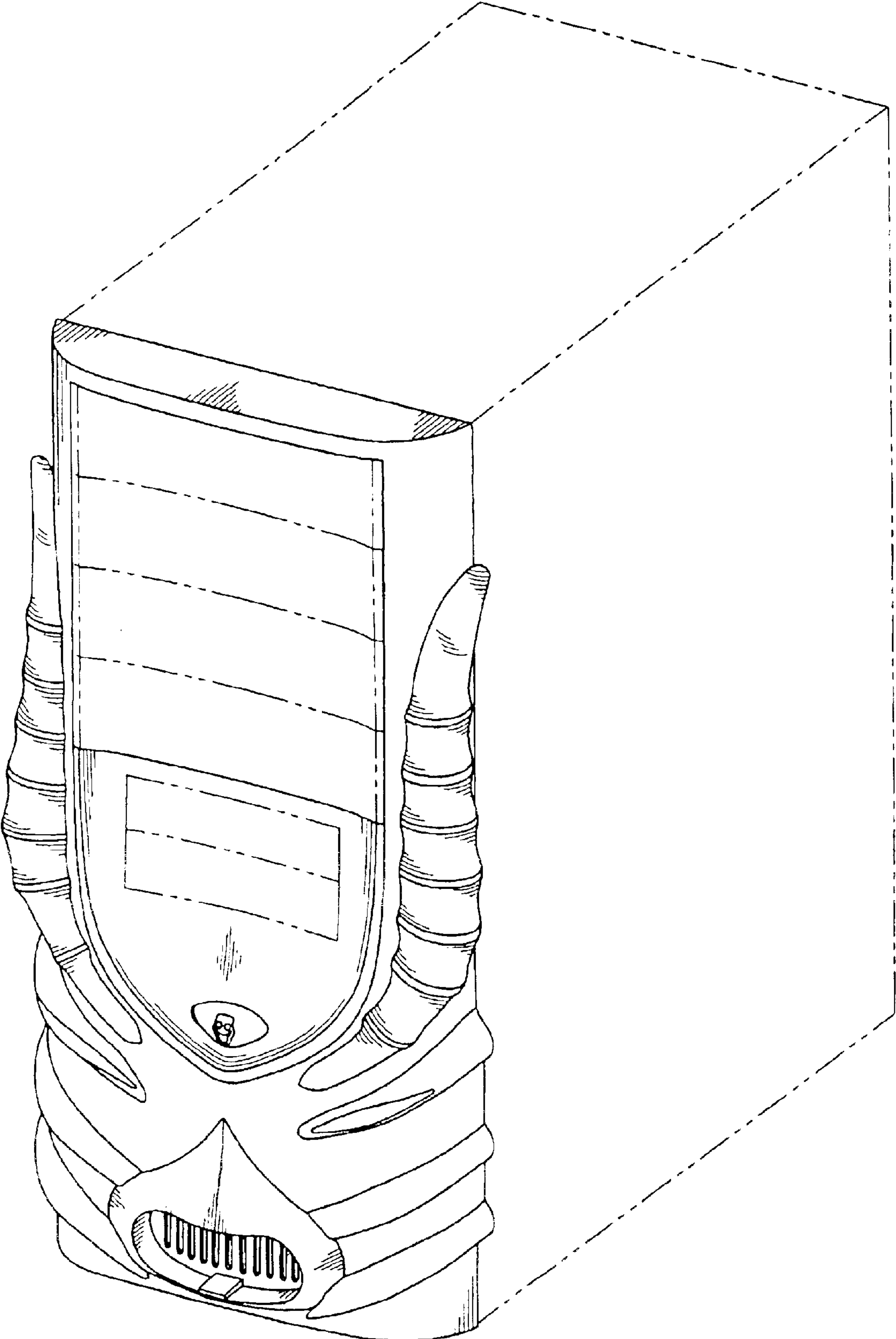

FIG. 8