

US00D498132S

(12) **United States Design Patent** (10) **Patent No.:** **US D498,132 S**  
**Lai** (45) **Date of Patent:** **\*\* Nov. 9, 2004**

(54) **COMBINATION PADLOCK WITH HORIZONTAL LOCKING BAR**

D460,341 S \* 7/2002 Ling ..... D8/330  
D477,209 S \* 7/2003 Yu et al. .... D8/334  
D477,525 S \* 7/2003 Ling ..... D8/330  
D483,647 S \* 12/2003 Lo ..... D8/333

(75) Inventor: **Eric Lai, Sheung Shui (HK)**

\* cited by examiner

(73) Assignee: **The Sun Lock Company Ltd. (HK)**

*Primary Examiner*—Prabhakar Deshmukh

(\*\*) Term: **14 Years**

(74) *Attorney, Agent, or Firm*—Melvin I. Stoltz

(21) Appl. No.: **29/186,819**

(57) **CLAIM**

(22) Filed: **Jul. 24, 2003**

The ornamental design for a combination padlock with horizontal locking bar, as shown and described.

(51) **LOC (7) Cl.** ..... **08-07**

(52) **U.S. Cl.** ..... **D8/334**

(58) **Field of Search** ..... D8/330, 331, 334;  
70/14, 20, 22, 24, 53, 58, 233

**DESCRIPTION**

(56) **References Cited**

**U.S. PATENT DOCUMENTS**

1,542,016 A \* 6/1925 Henry ..... 70/24  
5,433,092 A \* 7/1995 Kuo ..... 70/46  
5,488,844 A \* 2/1996 Winner ..... 70/18  
D398,830 S \* 9/1998 Winner ..... D8/333  
5,901,586 A \* 5/1999 Hale ..... 70/18  
D433,311 S \* 11/2000 Luquire ..... D8/333  
D433,312 S \* 11/2000 Luquire ..... D8/333

FIG. 1 is a perspective view of the combination padlock with horizontal locking bar showing my new design;  
FIG. 2 is a front plan view thereof, the rear view being a mirror image thereof;  
FIG. 3 is a side elevational view thereof, looking from the left side of FIG. 2;  
FIG. 4 is a bottom plan view thereof;  
FIG. 5 is a side elevational view thereof, looking from the right side of FIG. 2; and,  
FIG. 6 is a top plan view thereof.

**1 Claim, 3 Drawing Sheets**

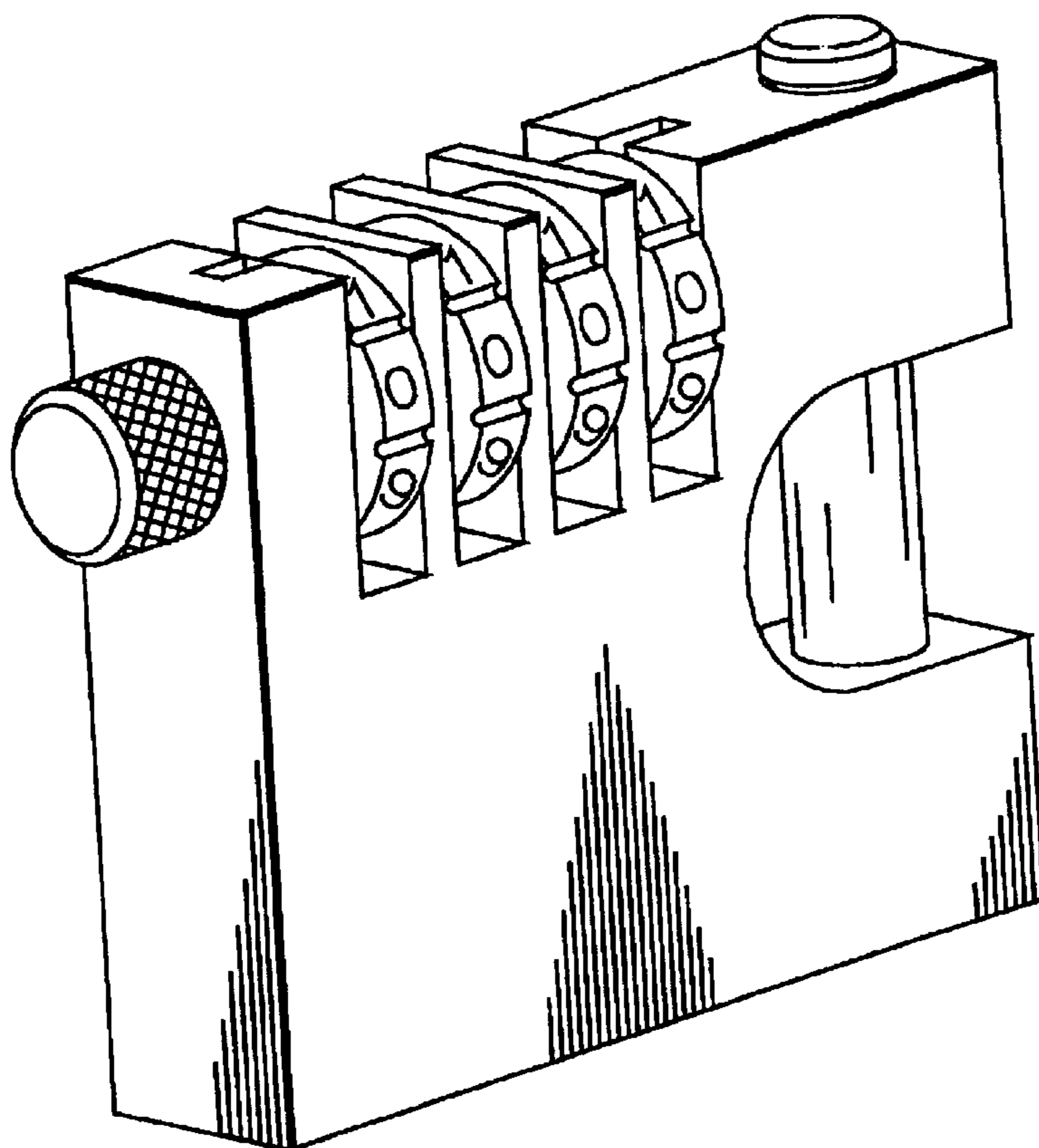

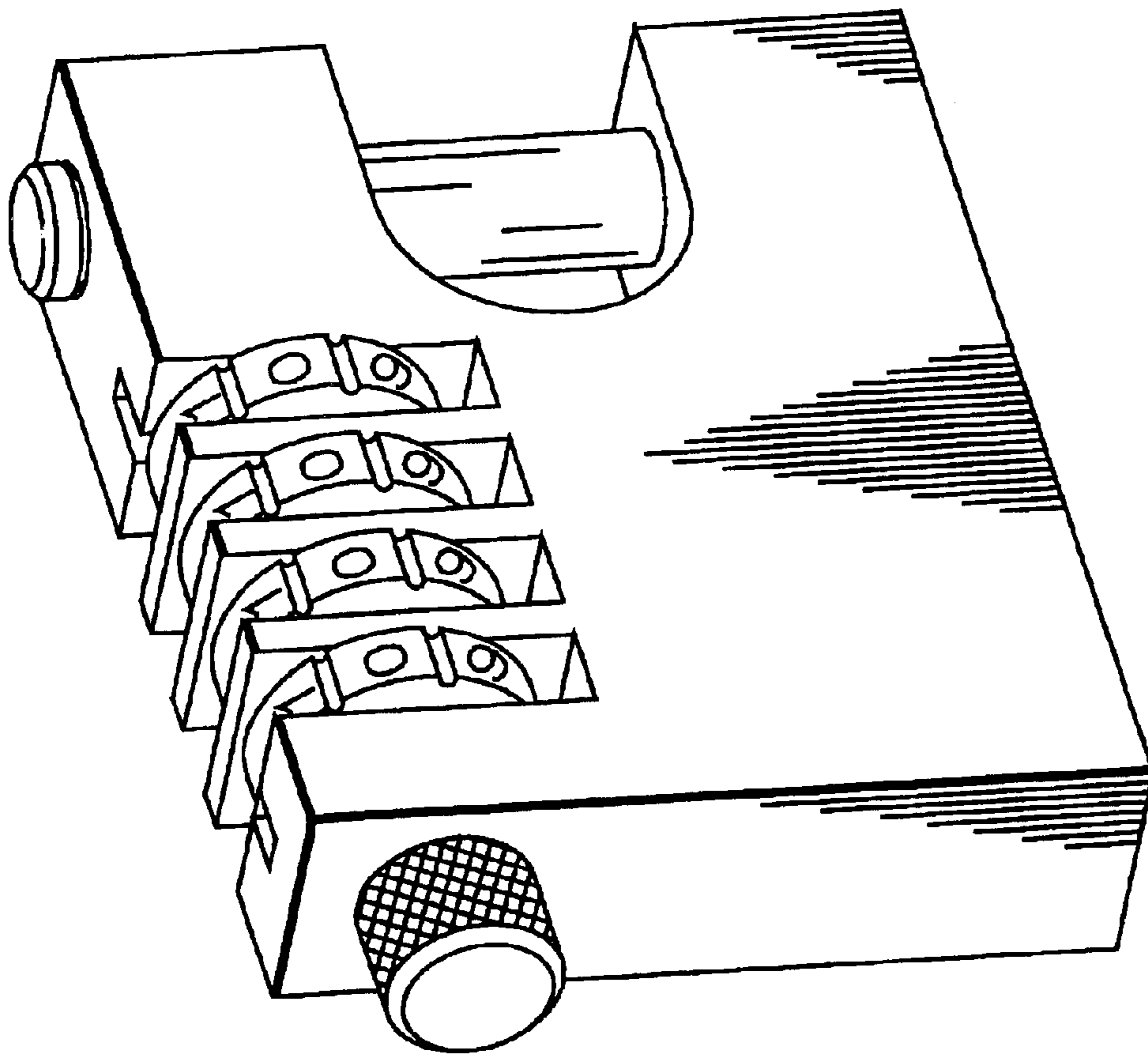

FIG. 1

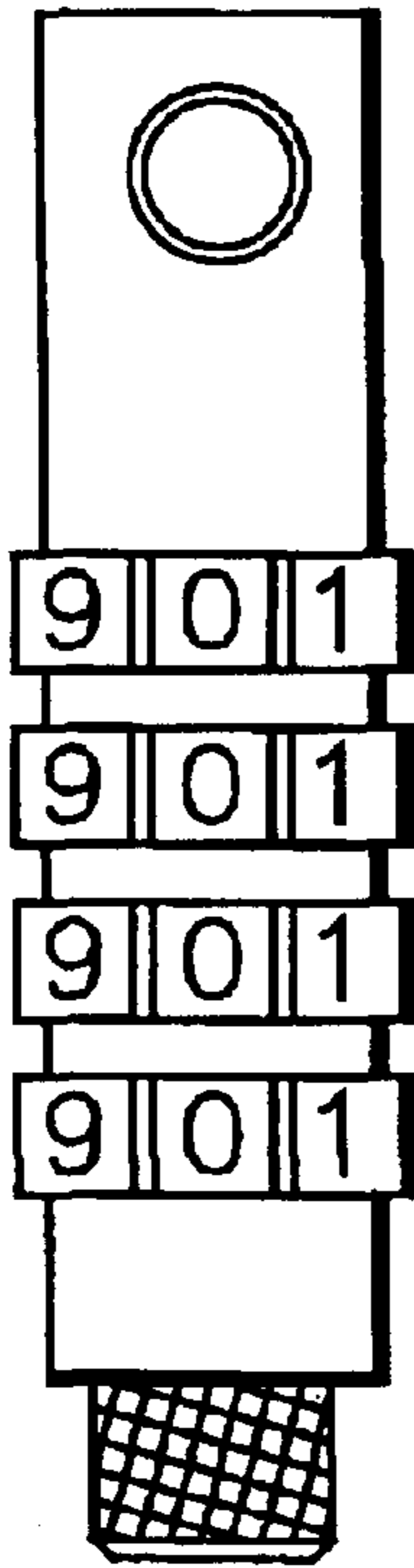

FIG. 3

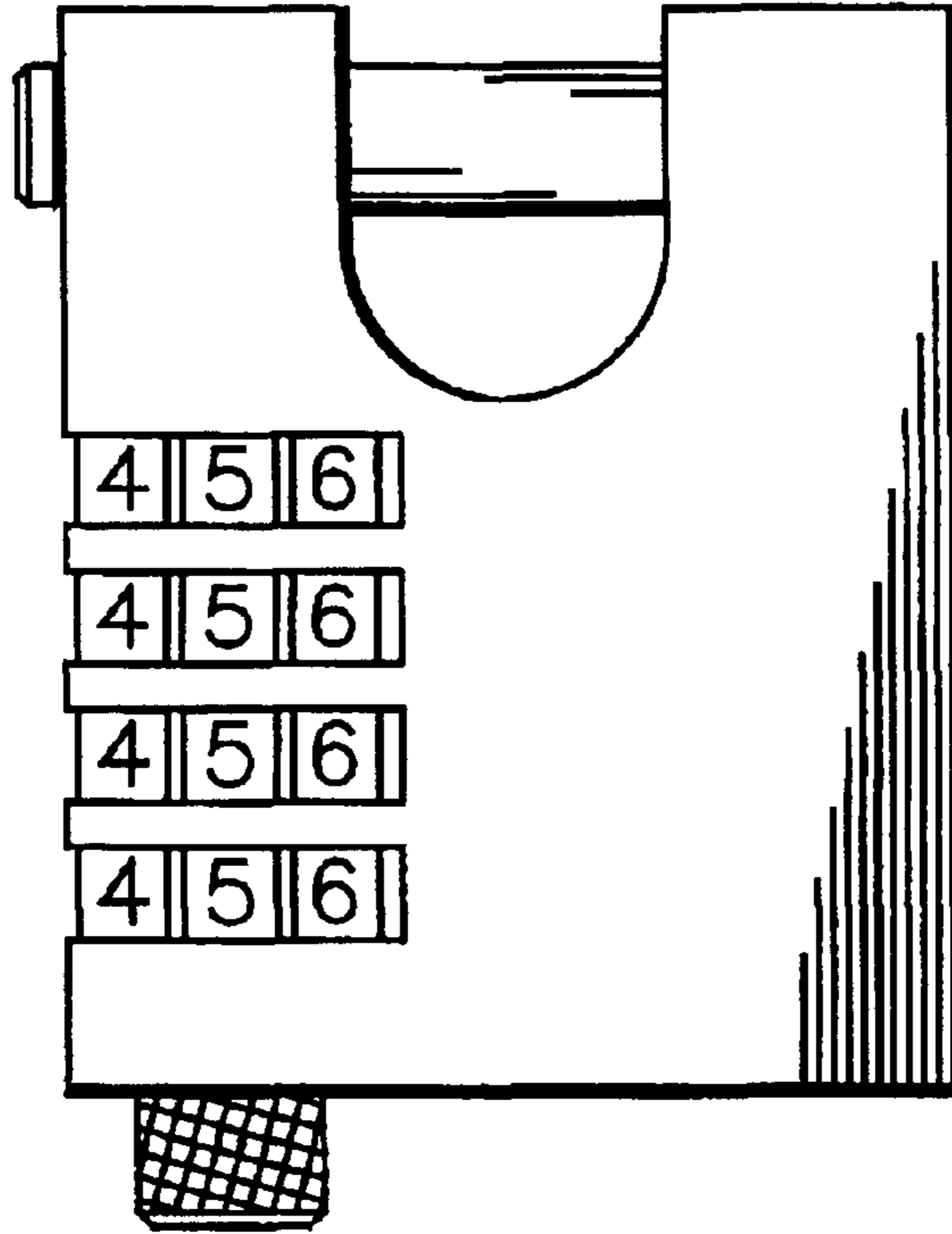

FIG. 2

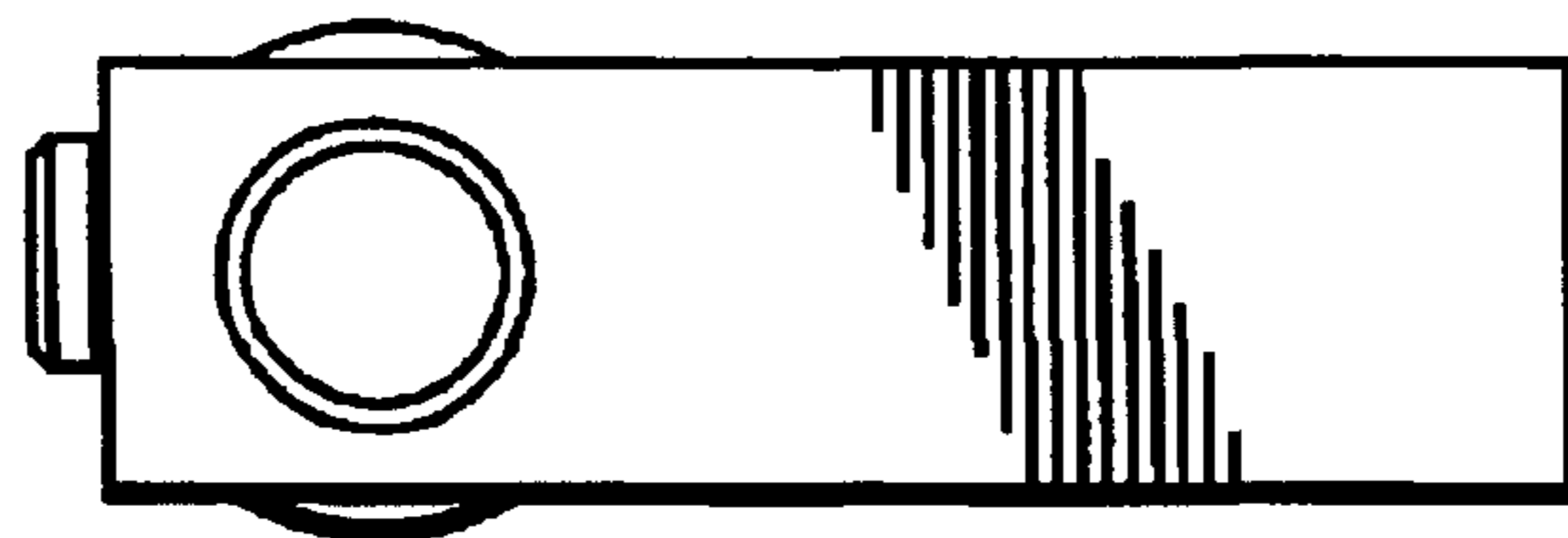

FIG. 4

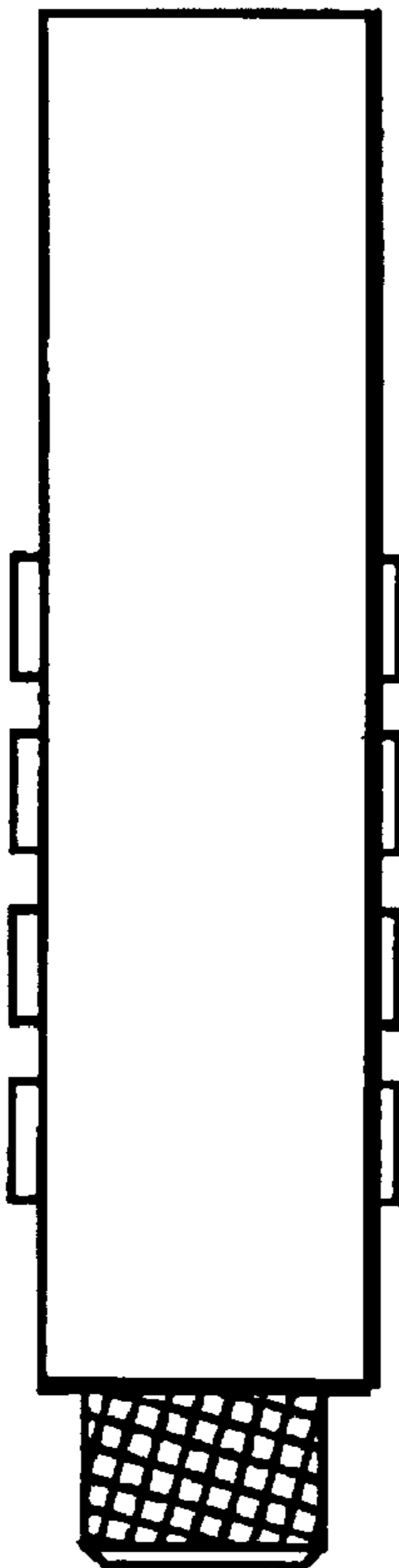

FIG. 5

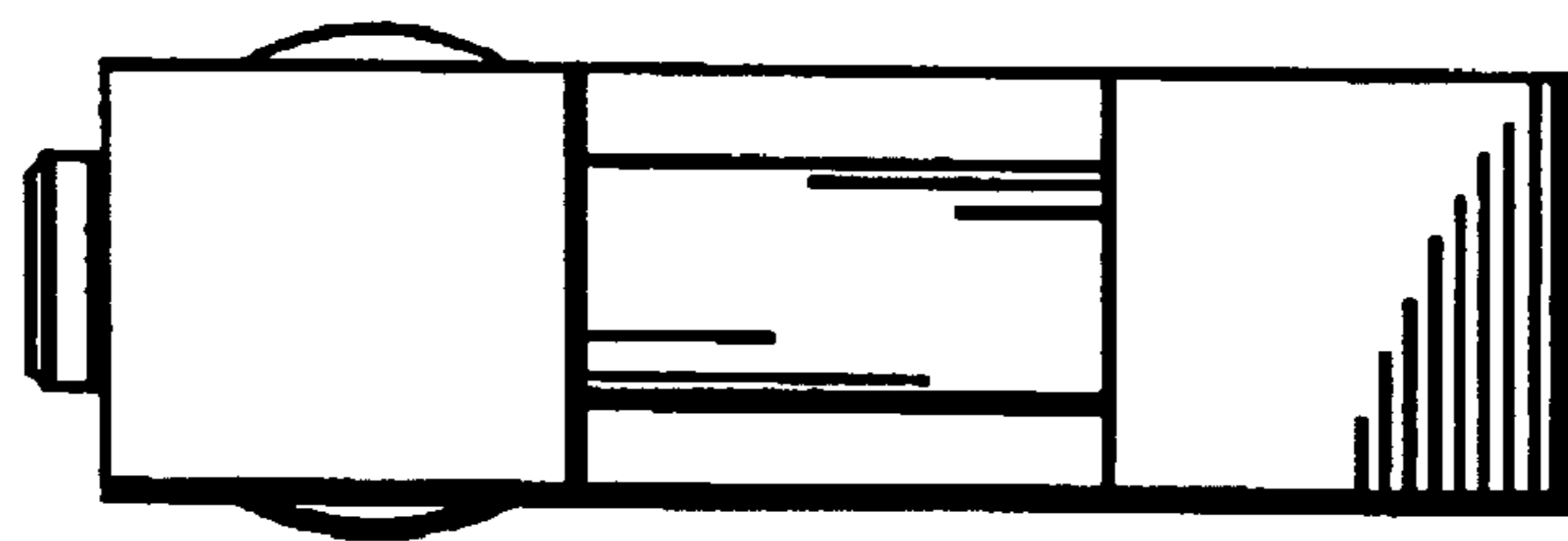

FIG. 6